

# Gaslight Auto Parts

1445 South US Hwy 68  
P.O. Box 291  
Urbana, OH 43078

Change Service Requested

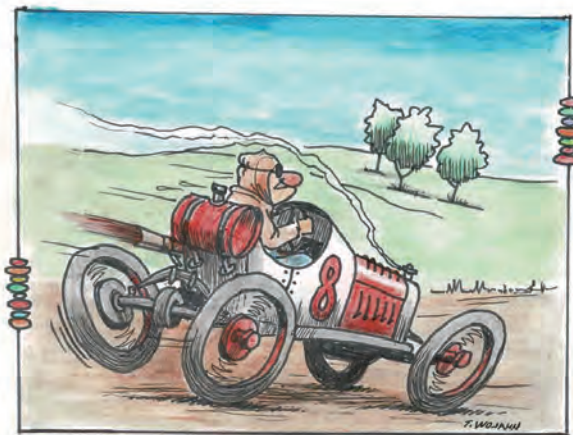

**800.242.6491** or 937.652.2145 **fax** 937.652.2147  
[sales@gaslightparts.com](mailto:sales@gaslightparts.com) [www.gaslightauto.com](http://www.gaslightauto.com)

2022

Gaslight Auto Parts



# Gaslight Auto Parts

Your source for 1909-1948  
**Ford Model T, A, & V8**  
Parts & Accessories



# Welcome to Gaslight

We have been serving the Restoration Hobby for over 55 years. May we help you?

For fast friendly service from people who care  
 phone **800.242.6491** or **937.652.2145**  
 fax **937.652.2147**  
 e-mail **sales@gaslightparts.com**

**Monday – Friday**  
**8:30 AM – 5:00 PM** EST  
 Closed Saturdays, Sundays, & Major Holidays  
*All prices subject to change.*

We accept Visa, Mastercard, and Discover.

Ford scripted items appearing in this catalog are licensed by Ford Motor Co.



# Gaslight Auto Parts

1445 South U.S. Hwy. 68, P.O. Box 291 • Urbana, OH 43078

**800.242.6491**

**www.gaslightauto.com**

Copyright 2019

# Table of Contents

Section	Page Numbers			Section	Page Numbers		
	T	A	V8		T	A	V8
Accessories/Extras	32-34	93-95	–	• Hats & Pins	161	161	161
Ammeter	23-24	72	–	Lube Charts	36	115	115
Axle—Front	6	50-51	120	Manifolds	11-12	68	131
Axle—Rear	4-5	54-55	122	Mirrors	33	91-92	145
Battery Parts	26	56	137-138	Muffler	20	56	124-123
Bodies	–	83	–	Nuts & Bolts	34	102-103	–
Books	36-38	115-117	149-152	Oil Pumps	12	60-61	126
Brakes	5,15-16	46-50	118-119	Patent Plates	34-35	95	–
Bumpers, etc	34	92-93	143-145	Pistons & Rings	9-10	58-59	125
Camshaft, etc	10-11	59	125	Radiator	18-20	63-65	128-129
Carburetor	26-28	69-70	131	• Apron	20	87	140
Clutch	14-15	62-63	128	• Lacing	20-21	88	140
Coils, Ignition	22-23	73-75	132-134	• Shell	–	64	128
Condensers	–	7	132,134	• Stone Guard	–	63	–
Dash Panels	–	73-74	–	Rubber Parts	36	105-106	141-143
Data Plates	34-35	95	–	Rumble Seat	–	101-102	137
Decals	42	42	42	Running Boards	22	86	–
Distributor	12-13	73-75	133	R/B Shields	21-22	87	–
Door Parts	29-30	95-100	146-148	Sheet Metal Parts	21	106-110	–
Door Handles	29-30	95-100	146-148	Shock Absorbers	–	93	145
Engine Parts	8-12	57-61	124-126	Spark Plugs	26	75	134
Exhaust System	11-12, 20	56, 68	122-123	Specifications	3	43	–
Fan	19-20	66	130	Speedometer	–	89-90	141
Fenders	–	84-85	133-139	Springs	18	57	123
Fenders Brackets	21-22	84-85	138-139	Starter	24-25	73	132
Fender Wells	–	86	138	Steering	16-17	51-54	121
Floor Boards	17	100-101	–	Tire Covers	34	46	–
Floor Mats	17	101	–	Tools	35-36	89	–
Frame	–	55-56	–	Top Parts	31-32	88-89	–
Fuel System	8	66-68	130-131	Transmission	13-15	61-63	127-128
Gear Shift	–	61-62	–	Trim Parts	34	114-115	140,128-129
Generator	25-26	71-72	131	Truck Parts	35	110-114	148
Glove Box	–	–	146	Turn Signals	–	77	–
Hood	20	87-88	140	Valves	11	60	126
Horn & Parts	30-31	80	–	Water Pump	19	65-66	129-130
Ignition	22-23	74-75	133-134	Wheels & Tires	6-8	44-46	118
Inner Tubes	8	46	46	Windshields	40-42	40-42	40-42
Lamps—Cowl	–	77-78	134-137	• Wipers	31	91	141-142
• Dome & Dash	–	80-81	137	Wiring	24-25	81	132
• Head	28-29	76-77	134-137	Wood	20-21	103-105	–
• Tail	28-29	78-80	135-136	License Brackets	32	76,78	122
• Bulbs	29	75-79	134-136	Posters	36	115	115

# 1909-48 Antique Ford Parts

*We  
appreciate  
Tom  
Wojahn's  
cartoon  
humor!*

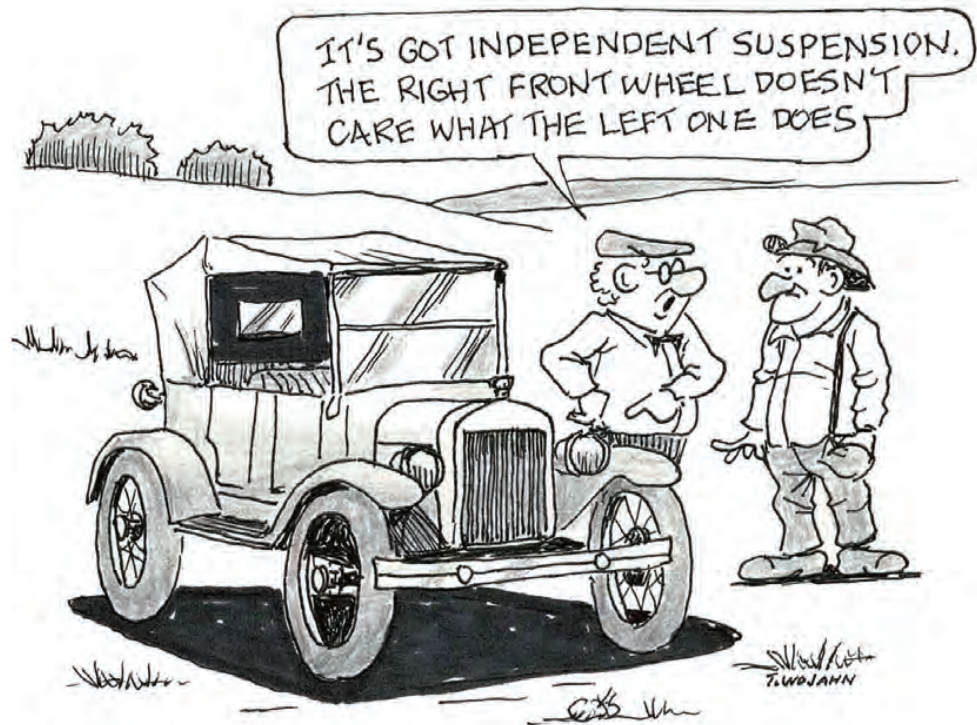

*For over 55 years we continue to source the highest quality parts and feature U.S.A. made on most. Many items are made with our tooling in the U.S.A.*

*When you call us on our toll-free line, you will talk to a parts department person who can not only take your order, but assist you with your needs.*

*Our shipping is fast using UPS on most shipments. We charge you our cost on shipments and do not add a handling charge. For freight shipments we have negotiated large discounts on the rates which we pass on to you.*

*Save a tree and get more frequent updates by requesting our digital catalog at [Gaslight@ctcn.net](mailto:Gaslight@ctcn.net) Or use our website for up to date prices.*

**Stop in and check out  
our new and used parts.**

**[sales@gaslightparts.com](mailto:sales@gaslightparts.com) 800.242.6491**

# Table of Contents



<b>Model T Parts</b> .....	pages 3-39
<b>Windshield Parts</b> .....	pages 40-42
<b>Model A Parts</b> (some Model B Parts).....	pages 43-117
<b>Model B &amp; V-8 Parts</b> .....	pages 118-152
<b>Books</b> .....	pages 153-160
<b>Extras</b> .....	page 161
<b>Used Parts</b> .....	page 162
<b>Order Forms</b> .....	pages 163-166

1909  
to  
1927



All prices listed in catalog subject to change. Call for current prices.

Helpful Information

## Specifications

<b>Engine</b>	4 Cylinder .....	Stroke 4"
	Bore 3-3/4" .....	Horsepower 20
	Firing Order .....	1-2-4-3
<b>Crankshaft Journals</b>	.....	1.248" Diameter
<b>Cam Bearing Clearance</b>	.....	.003 Side Play
<b>Valve Push Rod to Stem Clearance</b>	.....	.022 to .032
<b>Valve Spring Tension</b>	.....	24-28 Pounds
<b>Oil Capacity</b>	.....	4 quarts
<b>Coil Points Gap</b>	.....	.030"
<b>Spark Plugs Gap</b>	.....	.032"
<b>Crankshaft End Play</b>	.....	.015"

### *Motor Numbers for Reference Only:*

<b>1912</b> .....	698,877-157,205 .....	<b>1920</b> .....	3,277,885-4,233,350
<b>1913</b> .....	169,452-370,147 .....	<b>1921</b> .....	4,233,351-5,233,135
<b>1914</b> .....	370,148-570,790 .....	<b>1922</b> .....	5,223,136-6,334,196
<b>1915</b> .....	570,791-885,500 .....	<b>1923</b> .....	6,334,197-8,122,674
<b>1916</b> .....	885,501-1,362,200 .....	<b>1924</b> .....	8,122,675-10,266,471
<b>1917</b> .....	1,362,201-2,113,500 .....	<b>1925</b> .....	10,266,472-12,222,528
<b>1918</b> .....	2,113,501-2,756,251 .....	<b>1926</b> .....	12,222,529-14,049,029
<b>1919</b> .....	2,756,252-3,277,851 .....	<b>1927</b> .....	14,049,030-15,007,033

**We have many USED Model 'T' Parts...ask us.**

All prices listed in catalog subject to change. Call for current prices.

Part #	Description	Reqd.	Years	Price
<b>Rear Axle</b>				
2503-MB	Rear Axle Housing Bolt Set. USA.	1		2.95 set
2504-S	Rear Axle Housing Gasket Set. (6 pcs.)	1	1912-27	4.95 set
2505	Rear Axle Shaft. Forged steel, ground bearing surface. USA.	2	1912-27	99.95 ea.
2505-WP	Wheel Puller. Screw-on. Our superior design will not strip the threads on your axle. Made in Ohio. Not usable on Model T steering.	1	1912-48	4.95 ea.
2505-SH	Rear Axle Shims. Tapered.	2	1912-48	1.25 ea.
2506	Rear Axle Shaft Hard Fibre Washer.	1	1909-27	.50 ea.
2507	Rear Axle Shaft Castle Nut.	2	1909-48	1.00 ea.
2508	Axle Shaft Roller Bearing. (2 per side)	4	1909-27	14.95 ea.
2509	Rear Axle Roller Bearing Sleeve. Fits right side outer & left side inner. Case hardened.	2	1909-27	29.95 ea.
2509-B	Rear Axle Roller Bearing Sleeve. Fits left side outer & right side inner. Case hardened.	2	1909-27	29.95 ea.
2509-P	Rear Axle Sleeve Puller. Pass Car only.	1	1909-27	20.00 ea.
2510	Rear Axle Housing Cap.	2	1909-27	1.95 ea.
2510-A	Steel Bearing Washer. Outer.	2	1909-27	.75 ea.
2510-B	Rear Axle Outer Roller Bearing Felt Washer.	2	1909-27	.60 ea.
2510-AM	Modern Outer Grease Seals. USA. Aluminum sealed caps complete with instructions.		1909-18	49.95 pr.
2511-B	Spring Washer. For leather rear axle seal. (Teeth & taper face in).	2	1926-27	1.00 ea.
2511-C	Leather Rear Axle Oil Seal. (Taper faces in).	2	1926-27	2.50 ea.
2511-M	Neoprene Rear Axle Inner Seal.	2	1909-27	18.95 pr.
2511-W	Inner Washer for Leather Oil Seal.	2	1926-27	.80 ea.
2514-C	Differential Case Bolt.	3	1922-27	.95 ea.
2515	Differential Case Bolt Nut.	3	1909-27	.50 ea.
2516	Rear Axle Inner Roller Bearing Felt Washer. Heavy duty.	6	1909-27	2.00 ea.
2518/97-B	Ring & Pinion Gear. Ratio of 11/40 (3.64:1 ratio) Made in USA.	1	1909-27	475.00 ea.
2518/97-BHS	Ring & Pinion Gear, 3 to 1 Ratio, 13/39. Made in USA.	1	1909-27	525.00 ea.
2519-A	Differential Lock Rings.	1	1909-27	1.25 pr.
2521-B	Differential Gear Key.	2	1911-27	.65 ea.
2526-B	Differential Spider. Good used.	1	1911-27	12.50 ea.
2528	Differential Thrust Washer. Machined brass.	2	1909-27	12.95 ea.
2528-RT	Roller Thrust Assembly Set. Long lasting roller bearing replaces #2528 & #2529 thrust plates & washers. Need 2 sets per Pass. Vehicle.	2	1909-27	59.95 set
2529	Differential Thrust Washer. Steel hardened.	4	1909-27	5.95 ea.
2531-B	Thrust Plate Pin.	6	1917-27	.65 ea.
2532	Differential Oil Plug w/ Fiber Gasket.	1	1909-27	2.95 set
2545	Rear Axle Grease Cup. Steel.	2	1909-27	2.95 ea.
2545-B	Rear Axle Grease Cup. Brass.	2	1909-15	7.95 ea.
2548	Radius Rod Nut.	2	1909-27	.75 ea.



2504-S



2505-WP

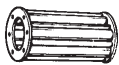

2508



2509-B



2509-P



2510



2510-B

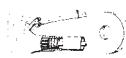

2516



2518/2597-B



2526-B



2528-RT



2551

All prices listed in catalog subject to change. Call for current prices.

Part #	Description	Reqd.	Years	Price
<b>Rear Axle</b>				
 2557	2551 Rear Radius Rod Mounting Set. Contains all nuts, bolts & washers to mount radius rods to drivetrain.	1	1909-27	12.95 set
 2561	2551-B Rear Radius Rod Bolt Nut.	4	1909-27	.75 ea.
	2557 Rear Brake Cam. Right side.	1	1909-25	9.95 ea.
	2557-B Rear Brake Cam. Right side.	1	1926-27	16.50 ea.
	2558 Rear Brake Cam. Left side.	1	1909-25	9.95 ea.
	2558-B Rear Brake Cam. Left side.	1	1926-27	16.50 ea.
	2559 Rear Brake Cam Bushing. Steel.	2	1909-25	.80 ea.
	2559-B Rear Brake Cam Bushing. Brass.	2	1926-27	3.50 ea.
	2560 Brake Drum Backing Plate w/Clips for Brake Shoe. Test fitted for alignment. Passenger side.	1	1926-27	49.95 ea.
	2561 Brake Drum Backing Plate w/Clips for Brake Shoe. Test fitted for alignment. Driver's side.	1	1926-27	49.95 ea.
	2563 Brake Camshaft Lever Pins. (2 pr. per car)	2	1909-25	.50 pr.
	2563-B Brake Camshaft Lever Pins. (1 pr. per car)	1	1926-27	.50 pr.
	2564 Clevis Pin.	4	1909-27	.25 ea.
	2566-A Lined Rear Brake Shoes. (4 pc. set)	1	1909-25	94.95 set
	2566-B Hub Brake Band Assy. w/Springs less Lining.	2	1926-27	39.95 ea.
	2566-D Brake Lining Set. Woven wire impregnated as original w/ rivets. (Set for 2 wheels)	1	1926-27	59.95 set
	2567 Brake Shoe Support Bolt.	2	1909-25	2.95 ea.
	2568 Nut. For brake shoe support bolt.	2	1909-25	.75 ea.
	2570-B Brake Shoe Coil Spring.	4	1909-25	1.25 ea.
	2570-C Brake Shoe Coil Spring.	2	1926-27	1.50 ea.
<b>Universal Joint</b>				
	2571 Universal Joint Assy. Excellent quality.	1	1909-27	124.95 ea.
	2571-B Universal Cap Bolt Set.	1	1909-27	7.95 set
	2571-T U Joint Wrench Used to rotate the drive shaft when installing the rear end.	1	1909-27	18.00 ea.
	2574 Universal Joint Knuckle Pin.	1	1909-27	.25 ea.
	2578 Universal Joint Housing Plug.	2	1909-27	2.75 ea.
	2578-A U-Joint Housing Plug. Domed. Early Style.	1	1909-18	1.50 ea.
	2579 Universal Joint Grease Cup. Steel.	1	1916-27	9.95 ea.
	2579-B Universal Joint Grease Cup. Brass.	1	1909-15	9.95 ea.
	2580 Universal Ball Cap Gasket.	2	1909-27	1.25 ea.
<b>Drive Shaft</b>				
	2581 Drive Shaft Housing Front Bushing. Brass.	1	1909-27	10.95 ea.
	2583-G Drive Shaft Bearing Housing Shim Gasket.	1	1909-25	.60 ea.
	2586 Drive Shaft Roller Brg. Housing Set Screw.	1	1911-21	2.95 ea.
	2587 Drive Shaft Roller Bearing.	1	1911-27	34.95 ea.
	2588 Drive Shaft Bearing Housing Spacer Washer. Fits #2583 housing.	1	1911-20	3.95 ea.
	2591 Drive Shaft Thrust Collar.	2	1911-27	13.95 ea.
	2591-B Drive Shaft Thrust Ball & Retainer.	1	1920-27	12.95 ea.
	2595-B Drive Shaft, New. High quality. USA. Don't ignore the stress of 80+ years on your old parts.	1	1909-27	189.95 ea.
	2596 Drive Shaft Sleeve. Hardened. USA. Fits #2587bearing.	1	1911-27	19.95 ea.
	2598 Drive Shaft Castle Nut.	1	1911-31	2.95 ea.

# Model Parts

All prices listed in catalog subject to change. Call for current prices.



2596-D



2710-S



2718-S



2718-T



2721-B



2736

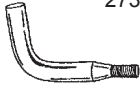

2740



2741

Part #	Description	Reqd.	Years	Price
2598-B	Drive Shaft Pinion Key.	1	1911-27	1.95 ea.
2691	Castle Nut Set. For front axle & steering gear. (8 pc. set)	1	1909-27	3.95 set
2696-D	Spindle Arm. Left side.	1	1919-27	5.95 ea.
2697	Spindle Arm Castle Nut.	2	1911-27	.75 ea.
2706	Front Wheel Adjusting Cone. Left thread.	1	1909-25	1.50 ea.
2707	Front Spindle Nut. Right thread. Fits driver's side spindle.	1	1909-27	4.50 ea.
2708	Front Spindle Nut. Left thread. Fits passenger side spindle.	1	1909-27	4.50 ea.
2709	Front Spindle Washer.	2	1909-27	1.00 ea.
2710-S	Spindle Bolt Set. (King Pin Set) USA. Hardened & ground. (10 pc. set)	1	1917-27	59.95 set
2713	King Pin Bushing. Machined brass. USA.	4	1909-27	4.95 ea.
2714	Spindle Arm Bushing. Steel.	2	1909-27	.80 ea.
2715-D	Spindle Bolt & Tie Rod Bolt Oiler. Drive-in type. Flip top. Cadmium plated.	4	1915-27	1.00 ea.
2718-AS	Tie Rod Bolt Set.	1		52.95 set
2718-S	Tie Rod Bolt Set. Includes bushings, nuts & flip top oilers.	1	1909-27	35.95 set
2718-T	Spindle Arm Bushing Driver. Also for front & rear spring perch bushing. Case hardened.	1	1909-27	12.95 ea.
2721-B	Tie Rod Ball Stud. (7/16" - 20). Tapered Shank.	1	1919-27	11.95 ea.
2722-B	Spindle Yoke Bolt Set. Special bolt, nut & cotter pin.	1	1919-27	1.95 set
2728	Ball Socket Cap. Steel. Fits #2725-B & C.	2	1909-27	12.95 ea.
2728-ACS	Accessory Ball Cap Repair Kit. Consists of seat, spring, threaded plug to rebuild the Apco spring loaded accessory style tie rod ball caps.	1	1911-27	6.95 kit
2729-B	Ball Socket Bolt & Nut Set. Holds ball socket Cap #2728. (1 per cap).		1909-27	2.00 set
2736	Front Radius Rod Ball Cap. Steel.	1	1909-27	13.95 ea.
2740	Speedometer Swivel "L" Bracket & Castle Nut. Fits Stewart U-joint.	1	1911-15	7.95 ea.
2741	Front Radius Rod Ball Cap Mounting Set. Fits 2737 & 2737-B. (7 pc. set)	1	1911-27	7.95 set



19" + 21"



30 X 3 + 30 X 3-1/2



16"



18"

## Wheels & Tires

2800-21	Replacement Hickory Spoke for 4:40 x 21" Wheel. (8-15/16ths overall)	12	1925-27	14.95 ea.
2800/30	Replacement Hickory Spoke for 30 x 3-1/2" Wheels. (Not for 30 x 3" wheel)	12	1909-25	16.95 ea.
2805-S	Front Inner Hub Ball Bearing Assy. N.O.S.	2	1909-25	2.95 ea.
2806	Outer Race Bearing Retainer Ring. N.O.S.	2	1909-25	.50 ea.



2800-21/30



Part #	Description	Reqd.	Years	Price
<b>Wheels &amp; Tires</b>				
2807	Inner Race Bearing Retainer Ring. N.O.S.	2	1909-25	.25 ea.
2809	Front & Rear Hub Felt Washer.	4	1909-25	.75 ea.
2816-B	Rear Axle Key. Hardened steel.	2	1912-27	.50 ea.
2818	Rear Brake Drum. For 5 stud wood wheel. Stamped steel. USA.	2	1909-25	37.95 ea.
2818-S	Rear Brake Drum. For 5 stud wire wheel. Stamped steel. USA.	2	1926-27	79.95 ea.
2818-W	Rear Brake Drum. For 6 stud wood wheel. Stamped steel. USA.	2	1926-27	79.95 ea.
2819-A	Hub Cap. Early script. Polished brass. Screw on cap for wood wheels.		1911-12	17.95 ea.
2819-B	Hub Cap. Script. Polished brass. USA. Screw on cap for wood wheels.		1913-16	18.95 ea.
2819-C	Hub Cap. Script. Chrome plated brass. USA. Screw on cap for wood wheels.		1917-27	19.95 ea.
2819-N	Hub Cap. Script. Nickel plated brass. USA. Screw on cap for wood wheels.		1917-27	19.95 ea.
2819-T	Hub Cap for Rear Wheels on 1 Ton TT Truck. Chrome plated brass. USA. Screw on cap for wood wheels.	2	1918-27	14.95 ea.
2819-W	Hub Cap. Ford wire wheel type. Nickerled. USA.		1926-27	16.95 ea.
2819-WB	Hub Cap. Ford wire wheel type. Polished brass. USA.		1926-27	12.95 ea.
2825	Rear Hub Bolt, 2-1/8" for Wood Wheels.	12	1911-27	1.40 ea.
2825-B	Hub Bolt Jam Nut. Front & rear on wood wheels.	24	1911-27	.25 ea.
2826	Front Hub Bolt. 2". For wood wheels.	12	1911-27	.70 ea.
2833	Front Wheel Bearing Cup. Inner. Timken.	2	1919-27	21.95 ea.
2834	Front Wheel Bearing. Inner. Timken.	2	1919-27	27.95 ea.
2836	Front Wheel Bearing Cup. Outer. Timken.	2	1919-27	10.95 ea.
2837	Front Outer Roller Bearing. Driver's side. Right hand thread. Timken.	1	1919-27	89.95 ea.
2837/38	Front Outer Wheel Bearing. A budget pair of outer wheel bearings for casual driving use.	1	1909-27	59.95 pr.
2838	Front Outer Roller Bearing. Left hand thread. Passenger side. Timken.	1	1919-27	89.95 ea.
2841	Front Hub Dust Seal.	2	1919-27	6.50 ea.
2848-S	Demountable Rim Nut & Bolt Set. Cadmium plated. 16 bolts & 16 beveled nuts. Fits Hayes & Ford rims.	1	1919-27	46.95 set
2849-C to F	Spare Rim Clamps. N.O.S. Assorted styles - <i>Send sketch.</i>		1921-25	6.95 ea.
2854-B	Rear Crossmember. N.O.S.		1914-25	29.95 ea.
2855 to 60-B	Frame Brackets. N.O.S. No body brackets. Assorted styles - <i>Send sketch.</i>		1909-27	7.50 ea.
2884-S	Wire Wheel Lug Nut Set w/spare Lock Lug nut. Chrome plated. 23 pcs.	1	1926-27	179.95 set
2886	Wire Wheel Front Hub Grease Retainer. Script.	2	1926-27	14.50 ea.



All prices listed in catalog subject to change. Call for current prices.

All prices listed in catalog subject to change. Call for current prices.

Part #	Description	Reqd. Years	Price
--------	-------------	-------------	-------

## Inner Tubes

CC-1	Inner Tube, 30 x 3-1/2. Use in 30 x 3 & 31 x 4 Tires.	1909-25	21.00 ea.
CC-2	Inner Tube, 4:50/5:50 x 21".	1925-29	21.00 ea.
CC-3	Inner Tube, 4:75/5:50 x 19". (Also used in 5:00 x 20").	1930-31	21.00 ea.
CC-4	Inner Tube, 5:25/5:50/6:50 x 17" or 18".		21.00 ea.
CC-5	Inner Tube, 5:50/6:00 x 16".		21.00 ea.
CC-21T	Lucas Tire 440/450 - 21" "Olympic" Tread. This is a cost effective 4 ply nylon tire. Import.	1925-29	99.00 ea.
CC-303T	Wards Riverside 30 x 3 Tire. A very popular replacement tire of the period. 4 ply nylon.	1908-18	151.00 ea.
CC-3035T	Wards Riverside 30 x 3.5 Tire. A very popular replacement tire of the period. 4 ply nylon.	1909-25	152.00 ea.



2901



2902-B



2901-B



2902-C



2902-B



2902-V



2908



2914/15



2914/15-B



2921



2990

## Gas Tank

2901	Gas Cap w/ Gasket. Early style.	1	1909-27	7.50 ea.
2901-B	Gas Cap. Brass plated. Later winged style.	1	1909-27	12.95 ea.
2901-G	Gas Cap Gasket. Fiberboard.	1	1909-27	.50 ea.
2902-B	Gasoline Sediment Bowl Assembly. Less drain petcock. Cast brass for early cars. Paint black for later cars. USA. (Use 2908 for drain petcock).	1	1909-27	69.95 ea.
2902-C	Gas Sediment Bowl & Shutoff Valve. All brass. Powder coated. USA.	1	1926-27	69.95 ea.
2902-SC	Screen only, fits all under tank mount sediment bowls.	1	1909-27	1.00 ea.
2902-V	Shut-off Valve. Modern ball valve rated 450 psi. Easy operation with no flow restriction in "On" position.	1	1909-27	13.95 ea.
2908	Drain Petcock for 2902-B Gasoline Sediment Bowl Assembly. Exact duplicate. USA.	1	1909-25	13.95 ea.
2910	Feed Pipe Pack Nuts. Brass.	1	1909-27	3.95 pr.
2913	Feed Pipe Pack Nut Felt Gaskets.	1	1909-27	.75 pr.
2914/15	Gas Tank Mounting Brackets for Round Tank.	1	1913-20	25.00 set
2914/15-B	Gas Tank Mounting Brackets for Oval Tank.	1	1920-25	25.00 set
2916	Gas Line to Frame Clamp w/ Mounting Bolt.	1	1921-27	3.95 ea.
2917	Upper Gas Tank Pads. This fits between top of tank & cowl supports that go from dash to firewall. Adhesive backing allows placing them on top of tank. Rubber.	1	1926-27	4.95 pr.
2919	Lower Gas Tank Pads. Rubber pads fit between bottom of gas tank & the tank support straps.	1	1926-27	10.95 pr.
2921	Gas Tank Overflow Pipe Assembly w/ Clamp. Fits cowl tanks.	1	1926-27	27.95 ea.

## Motor Cylinder

2990	Engine Castle Nut Set. (36 pcs.)	1	1909-27	19.95 set
3000-L	Engine Lift Eye.	1	1909-27	8.95 ea.
3000-S	Engine Green Paint. Spray can.		1925-41	8.00 ea.
3002-C	Head Gasket. Copper faced.	1	1909-27	36.95 ea.

**Part # Description Req'd. Years Price**

## Motor Cylinder



3002-M



3003-N

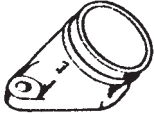

3004



3004-E



3005



3009-C



3012-S



3015



3017



3021





3002-CLH	<b>NEW</b> Engine Gasket set, Less Head Gasket.			46.95 set
3002-FS	Complete Engine Gasket Overhaul Set. Includes copper head gasket.	1	1909-27	64.50 set
3002-M	Modern Steel Core Gasket with Silicone Coating. No other sealant required.	1	1909-27	28.95 ea.
3002-S	Head Gasket. Steel.		1909-27	19.95 ea.
3003-A	Cylinder Head Bolt. Shorter version used on low (early) heads.	15	1909-17	1.65 ea.
3003-B	Cylinder Head Bolt. Longer version used on high heads.	15	1918-25	2.25 ea.
3003-N	Cylinder Head Bolt. Nickel plated. Domed top bolt.	15	1918-27	1.75 ea.
3004	Cylinder Head Water Outlet Connection.	1	1909-16	23.50 ea.
3004-B	Cylinder Head Water Outlet Connection.	1	1917-25	29.95 ea.
3004-E	Cylinder Head Outlet Connection. The bronze cast will never rust. Excellent quality. USA.	1	1926-27	129.95 ea.
3005	Cylinder Water Outlet Gasket.	1	1909-27	.50 ea.
3008	Cylinder Water Inlet & Outlet Mounting Bolts. (4 pc. set)	1	1909-27	1.95 set
3009-C	Cylinder Front Cover. Used.	1	1919-26	15.00 ea.
3009-D	Cylinder Front Cover. Used.	1	1926-27	15.00 ea.
3012	Crankshaft Front Felt Seal. (2 pc. set)	1	1909-27	.75 set
3012-S	Modern Crankshaft Seal. This modern seal does the trick. Replaces 3012 felts. Instructions included. No modifications.	1	1909-27	6.95 ea.
3013	Cylinder Cover Gasket. For engine without generator.	1	1909-19	1.00 ea.
3013-B	Cylinder Cover Gasket. For engine with generator.	1	1919-27	2.25 ea.
3015	Cylinder Water Inlet. Cast iron. USA.	1	1909-27	37.95 ea.
3017	Timing Gear Cover. Used.	1	1919-27	9.95 ea.
3017-C	Timing Gear Cover Gasket. For engine with generator.	1	1919-27	.75 ea.
3018	Cylinder Water Inlet Gasket.	1	1909-27	.50 ea.
3019-B	Water Freeze Plugs. (Set of 3)	1	1914-27	1.00 set

## Motor Pistons & Connecting Rods

3021	Aluminum Pistons w/ Pins. T Slotted. Camground. Increases performance with less whip. Standard size. (Set of 4)	1	1909-27	115.00 set
3021-HC	High Compression Pistons. Special domed top Piston will increase Power & Compression Rings (not included). Not to be used with High Compression Head. <b>Specify Size: Std., .020, .030, .040, .060, .080</b>	1	1909-27	129.95 set
3021-20	Aluminum Pistons w/ Pins. (As above) .020 Size. (Set of 4)	1	1909-27	115.00 set
3021-30	Aluminum Pistons w/ Pins. (As above) .030 Size. (Set of 4)	1	1909-27	115.00 set
3021-40	Aluminum Pistons w/ Pins. (As above) .040 Size. (Set of 4)	1	1909-27	115.00 set
3021-60	Aluminum Pistons w/ Pins. (As above) .060 Size. (Set of 4)	1	1909-27	115.00 set

All prices listed in catalog subject to change. Call for current prices.

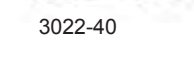
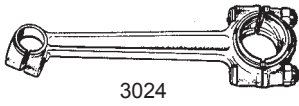
All prices listed in catalog subject to change. Call for current prices.

Part #	Description	Reqd.	Years	Price
<b>Motor Pistons &amp; Connecting Rods</b>				
 3022	Piston Ring Set for Aluminum Pistons. Standard Size.	1	1909-27	62.00 set
 3022-20	Piston Ring Set for Aluminum Pistons. .020 Size.	1	1909-27	62.00 set
 3022-30	Piston Ring Set for Aluminum Pistons. .030 Size.	1	1909-27	62.00 set
 3022-40	Piston Ring Set for Aluminum Pistons. .040 Size.	1	1909-27	62.00 set
 3022-60	Piston Ring Set for Aluminum Pistons. .060 Size.	1	1909-27	62.00 set
3023	Piston Ring Set for Cast Iron Pistons. Standard Size.	1	1909-27	54.95 set
3023-HC	Piston Rings for High Compression Pistons.	1	1909-27	64.95 set
<i>Specify Size: Std., .020, .030, .040, .060, .080</i>				
3023-20	Piston Ring Set for Cast Iron Pistons. .020 Size.	1	1909-27	61.95 set
3023-30	Piston Ring Set for Cast Iron Pistons .030 Size.	1	1909-27	61.95 set
3024	Connecting Rods. Rebabitted with spun alloy in Std., .010, 020. <b>Sold exchange only.</b> (Set of 4)		1909-27	295.00 set
3024-OD	Connecting Rod Oil Dips for 4 Rods.	1	1909-27	16.95 set
3025-N	Connecting Rod Nut Set. Special nuts for #3025 connecting rod bolt. (8 pc. set)	1	1909-27	4.95 set
3027-S	Connecting Rod Shims. Laminated. (Set of 8)		1909-27	7.95 set
3029	Connecting Rod Clamp Screw. (Wrist or piston pin locking bolt.) Drilled head.		1909-27	2.75 ea.
<b>Crank &amp; Camshaft</b>				
3031	Rear Main Bearing Cap. Spun alloy babbitt. <b>Sold exchange only.</b>	1	1909-27	65.00 ex.
3032	Crankshaft Front Main Bearing Cap. <b>Exchange.</b>	1	1909-27	52.50 ex.
3033	Crankshaft Center Bearing Cap. <b>Exchange.</b>	1	1909-27	52.50 ex.
3038/9-S	Main Bearing Shims. Front, Center & Rear. Laminated. (Set of 6 pcs.)	1	1909-27	7.95 set
3040	Crankshaft Starting Pin.	1	1909-19	.50 ea.
3040-B	Crankshaft Starting Pin.	1	1920-27	.75 ea.
3041-S	Modern Camshaft Seal. The modern way to keep the oil where it belongs. No modifications. Instructions included.	1	1909-27	6.95 ea.
3042-B	Front Cam Bearing, Short style. This bearing is used if the number 1 lobe is wider. USA.	1	1924-27	47.95 ea.
3042-TK	Cam Thrust Kit. Designed to eliminate noise at low RPM's.	1	1912-27	36.95 set
3043	Center Cam Bearing. USA.	1	1909-27	67.95 set
3044	Rear Camshaft Bearing. Bronze.	1	1909-27	5.95 ea.
3044-DR	Camshaft Rear Bushing Driver.	1	1909-27	9.95 ea.
3045	Camshaft Bearing Rings.	1	1909-27	3.95 pr.
3046	Camshaft Bearing Set Screws.	1	1909-27	7.95 pr.

All prices listed in catalog subject to change. Call for current prices.

Part #	Description	Reqd.	Years	Price
<b>Crank &amp; Camshaft</b>				
3047	Precision Machined Timing Gear. From Tenzaloy aluminum. Smooth & quiet under any load.	1	1909-27	79.95 ea.
3047-B	Fiber Camshaft Timing Gear. Bevel teeth. Size .003" oversize.	1	1909-27	59.95 ea.
3047-BA	New Improved Nylon 71/2 Degree Advanced Timing Gear w/special Nut. Made from orig. Ford drawings. Will give the engine noticeably more power.		1909-27	64.95 ea.
3047-BS	Standard Nylon Timing Gear w/special nut. This gear runs very quiet.		1909-27	64.95 ea.
3048-B	Steel Crankshaft Timing Gear. Bevel teeth. Standard size.	1	1909-27	24.95 ea.
3049	Camshaft Gear Dowel Pin.	2	1909-27	1.50 ea.
3050-B	Camshaft Gear Lock Nut.	1	1912-27	4.95 ea.
3050-BT	Cam Gear Nut Tool. Socket style tool for install or removal.	1		28.95 ea.
3051	Crankshaft Gear Key.	1	1909-27	.50 ea.
<b>Valves &amp; Push Rods</b>				
3052	Valve. Intake & Exhaust. Standard. .312 dia. stem. Stainless steel.	8	1909-27	9.50 ea.
3052-B	Valve. Intake & Exhaust. .015 o.s. .327 dia. stem. Stainless steel.	8	1909-27	8.95 ea.
3052-C	Valve. Intake & Exhaust. .030 o.s. .342 dia. stem. Stainless steel.	8	1909-27	9.50 ea.
3052-G	Valve Setting Gauge. Stainless steel. Sets valve clearance by piston travel. Inst. incl.	1	1909-27	14.95 ea.
3052-R	Valve Guide Reamer. 1/64 o.s. USA. Reams worn guides to .3275.	1	1909-27	59.95 ea.
3053	Valve Spring Compressor Tool. Quality tested for proper fit. Instructions included.	1	1909-27	34.95 ea.
3054	Valve Springs. Standard. (set of 8)	1	1909-27	4.50 set
3055	Valve Seats. Cast Iron.	1		3.95 ea.
3056-S	Valve Spring Seats. (set of 8)	1	1909-27	6.95 set
3057-S	Valve Spring Pins. (set of 8)	1	1909-27	1.25 set
3058-AJ	Push Rods. Adjustable type. Std. size. (set of 8) .437 od. 7/16" dia.	1	1909-27	64.95 set
3058-BAJ	Push Rods. Adjustable type. 1/64" o.s. Stem. (set of 8) .4526 od.	1	1909-27	64.95 set
3058-CAJ	Push Rods. Adjustable type. 1/32" o.s.. Stem. (set of 8) .468 od.	1	1909-27	64.95 set
<b>Manifold</b>				
3060-B	Exhaust Manifold. Exact duplicate. USA.	1	1913-27	89.95 ea.
3061	Exhaust Pipe Pack Nut. Brass.	1	1909-27	11.95 ea.
3061-W	Exhaust Pack Nut Wrench. Made in USA. A much needed tool to tighten or remove the exhaust pack nut. Ductile iron.	1	1909-27	31.00 ea.
3062-HV	Aluminum Hi-Volume Intake Manifold. Provides a 53% increase in air flow. Fits all except vaporizer systems.	1	1909-27	114.95 ea.



3047-BA



3047-BS



3047-B



3048-B



3052-G

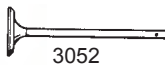

3052



3053



3056-S



3054



3057-S



3058-AJ



3060-B



3061



3061-W



3062-HV

# Model Parts

All prices listed in catalog subject to change. Call for current prices.



3062-S



3063/4-S



3069



3070/71-B



3068-B



3079

3081-HV



3080-RK

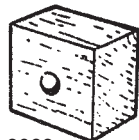

3083

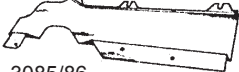
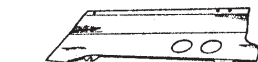

3085/86

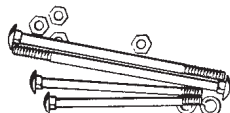

3088-BCS

**Part # Description Req'd. Years Price**

## Manifold

3062-S	Exhaust & Inlet Gasket Set. E-Z drop-in style. Steel Backed (still EZ drop-in)	1	1909-27	9.95 set
3063/4-S	Manifold Gasket Set. Original type w/ 6 copper crush rings slipped over 6 steel gland rings. Aligns both manifolds with the block.	1	1909-27	9.95 set
3063-CR	Copper Manifold Gasket Set. (6 pcs.) Heat resistant heavy copper ring style gasket set. Each ring fits into engine block & manifold.	1	1909-27	29.95 set
3063-S	Inlet & Exhaust Manifold Copper Crush Rings. (6 pc. Set)	1	1909-27	7.95 set
3063-S	Inlet & Exhaust Manifold Copper Crush Rings.	1	1909-27	7.95 set
3064-X	<b>NEW</b> Manifold Gaskets. Paper Type.	1	1909-27	2.95 set
3066-B	Manifold Studs with Nuts. (8 pc. set) USA. Later straight shank stud. Works okay for all years.	1	1909-27	7.50 set

## Crankcase & Cylinder Valve Cover

3068-B	Brass Oil Cap. Script.	1	1909-14	22.95 ea.
3069	Dipstick Kit. Remove lower petcock for easy installation. Mounting bracket & tube are black powder coated .	1	1909-27	46.95 kit
3070/71-B	Crankcase to Cylinder Gaskets.	1	1909-27	2.50 pr.
3079	Crankcase Drain Petcock. Leakproof. Solid brass. USA. (Crankcase uses 2 of these to check the oil).	2	1909-27	13.95 ea.
3079-SG	Oil Sight Gauge. Brass.	1	1909-27	17.95 ea.
3080-RK	Oil Pan Drain Plug Repair Kit. Repair that leaky drain plug with the engine still in your car. Just a simple task. Instructions incl. Works for T & A pans.	1	1909-31	12.95 kit
3080-S	Oil Drain Plug & Fiber Gasket Set.	1	1909-27	2.95 set
3081-HV	High Volume Oil Line Kit. Delivers 10 times the oil to front of your engine, uphill or down, fast or parade slow. All needed parts including instructions. Best if done on workbench.	1	1909-27	87.95 kit
3081-HVB	High Volume Oil Line Brackets Only. Less Line and Fittings.		1909-27	33.95 pr.
3083	Crankcase Arm Blocks. Hardwood.	1	1909-27	3.95 pr.
3083-B	Engine Support Bolt Set. (12 pc. set)	1	1909-27	8.95 set
3085/86	Engine Splash Pans. These go between the motor & frame.	1	1909-27	67.50 pr.
3088-BCS	Engine Pan & Hood Sill Bolt & Nut Set w/ Washers.	1	1909-27	2.95 set
3100-MB	Oil Pan Mounting Bolt Set. The special head bolts & nuts with cover pins. (66 pcs.)	1	1911-27	41.95 set
3101-BS	Lower Oil Pan Bolt Set. (15 pcs.)	1	1912-27	2.50 set
3102-B	Crankcase Lower Cover Gasket.	1	1912-24	3.95 ea.
3102-C	Crankcase Lower Cover Gasket.	1	1924-27	3.95 ea.
3104	Oil Pan Supports.	1		39.95 ea.
3111-B	Valve Cover Gasket.( 2 pc.)	1	1912-21	2.25 pr.
3111-C	Valve Cover Gasket.	1	1921-27	1.75 ea.

All prices listed in catalog subject to change. Call for current prices.

Part #	Description	Reqd.	Years	Price
<b>Commutator</b>				
3158-M	Modern Stop/Brake Light Switch. Heavy duty. This kit will work with 6, 8, & 12 volt systems – positive or negative ground.	1	1909-27	36.95 kit
3158-SX	Stop Light Switch. Clamps on starter cover. Authentic duplicate.	1	1919-27	34.95 ea.
3160	Distributor Ignition Assembly. New bolt-on distributor mounts on timing cover without modification. Works on 6 or 12 volt system. All necessary hardware & instructions included.	1	1912-27	359.95 ea.
3160-A	Distributor Plug Wire Set. Complete w/ rubber insulation boots. Fits 3160 distributor.	1	1912-27	34.95 set
3160-B	Spark Plug Wire Bracket Set. Original accessory fits under 2 head studs keeping distributor wires away from exhaust manifold.	1	1912-27	12.95 set
3160-C	Ignition Coil & Bracket. 6 volt. Used with our 3160 distributor ignition system. Bracket for firewall included.	1	1912-27	19.95 ea.
3160-E	Solid State Electronic Ignition. For our distributor or any Bosch 009 distributor. Uses 12v coil. Easier starting and smoother idle & running. Easy instruction.	1	1912-27	129.95 ea.
3162-B	Commutator Case Support Bolt. Used to bolt #3163, which holds the commutator to front of engine.	1	1919-27	2.25 ea.
3163	Commutator Case Spring. Holds commutator to front of engine. Used with #3162-B	1	1912-27	1.95 ea.
3165	Roller Type Timer. High Quality. USA.	1	1911-27	85.00 ea.
3170	Timer Calibrating Gauge. Authentic tool for Tiger Timer.	1	1911-27	1.25 ea.
3176-C	Commutator Oiler. Drive-in, flip top type. Cadmium plated.	1	1917-27	.85 ea.
3177	Timer Felt Washer. Heavy duty.	1	1912-27	.60 ea.
3206/7	Timer Brush Cap & Pin Set. Fits on end of camshaft.	1	1911-27	1.95 set
3207	Brush Cap Pin.	1	1911-27	.25 ea.
3220	Timer Lock Nut on Camshaft.	1	1911-27	2.75 ea.
3222	Commutator Shield. Brass. Fits between timer & cover.	1	1911-27	2.95 ea.
<b>Magneto &amp; Flywheel</b>				
3250-A	Magneto Coil Assembly. Double stack style. Rebuilt & tested. <b>Sold exchange only.</b>	1	1915-18	249.95 ex.
3250-D	Magneto Coil Assembly. Single stack style w/ notch for starter. Rebuilt & tested. <b>Sold exchange only.</b>	1	1919-27	235.00 ex.
3257	Magneto Support Spool.	16	1909-27	1.50 ea.
3260-A	Magneto Post. Replacement type.	1	1909-25	19.95 ea.
3260-B	Magneto Post. Replaces shorted or damaged assembly.	1	1926-27	16.95 ea.
3268	Flywheel Ring Gear. Drilled & hardened. USA.	1	1919-27	47.95 ea.
3270	Flywheel Cap Screw. Drilled head.	4	1909-27	7.95 ea.
3271	Flywheel Dowel Pin.	2	1909-27	1.95 ea.
3272-C	Magneto Coil Support Shim. Steel.	4	1909-27	1.00 ea.



3158-M



3158-SX



3160



3160-C



3160



3165



3170



3177



3206/7



3222



3250-D



3260-B

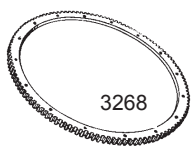

3268

# Model Parts

All prices listed in catalog subject to change. Call for current prices.

Part #	Description	Reqd.	Years	Price
<b>Magneto &amp; Flywheel</b>				
3272-LS	Magneto Coil Shim. Laminated brass.	4	1909-27	1.70 ea.
3277	Magneto Magnet Clamp. Stamped steel. Exact duplicate.	16	1911-27	3.25 ea.
3278-S	Brass Magnet Screws. (set of 16)	1	1911-27	22.95 set
3279	Magneto Post Gasket.	1	1909-25	.35 ea.
<b>Transmission</b>				
3304	Transmission Reverse Gear Bushing. Oil impregnated SAE 841 sintered bronze.	1	1909-27	11.95 ea.
3309	Transmission Slow Speed Gear Bushing. Oil impregnated SAE 841 sintered bronze.	1	1909-27	8.95 ea.
3312	Transmission Brake Drum Lug Shoe.	6	1926-27	1.95 ea.
3313	Triple Gear. Good used. (Will need rebushed)	3	1909-27	19.95 ea.
3314-1/2	Transmission Triple Gear Bushing. Flanged. Oil impregnated SAE 841 sintered bronze.	3	1911-27	5.95 ea.
3314-D	Triple Gear Bushing Driver. Hardened steel.	1	1911-27	8.95 ea.
3315	Triple Gear Pin. Hardened steel. Slight oversize provides snug fit (3 pc. set).	1	1909-27	12.95 set
3315-STD	Triple Gear Pin, Hardened Steel. Std. size (3 pc. Set)	1	1909-27	34.95 set
3318	Transmission Driven Gear Key.	2	1909-27	.35 ea.
3320-C	Transmission Driven Gear Sleeve Bushing. Oil impregnated SAE 841 sintered bronze.	1	1909-27	5.95 ea.
3320-D	Transmission Driven Gear Sleeve Washer. (Brake drum thrust washer) (3 pc. set)	3	1917-27	2.50 set
3327-B	Transmission Driving Plate Bushing. Oil impregnated SAE 841 sintered bronze.	1	1909-27	3.95 ea.
3328	Transmission Clutch Disc. Round. Replaces warped/worn originals with 80 to 96 years of use. USA.	12	1909-27	5.95 ea.
3328/9	Jack Rabbit Accessory Clutch Set. Provides smooth shifting & accurate neutral. Used with 9 stock hex plates. Total 17 plates.	1	1909-27	96.00 set
3329	Transmission Clutch Disc. Hex type. Replaces warped/worn originals with 80-96 years of use. USA.	13	1909-27	4.50 ea.
3331	Transmission Gear Shaft. This is the main shaft that the drums are mounted on. USA.		1909-27	210.00 ea.
3333	Transmission Clutch Disc. Drum Key.	1	1909-27	.50 ea.
3334	Trans. Clutch Drum Set Screw. N.O.S.	1	1909-27	1.95 ea.
3336	Transmission Clutch Push Ring.	1	1909-27	17.50 ea.
3337	Transmission Clutch Finger. N.O.S.	3	1909-25	4.95 ea.
3337-1/2	Transmission Clutch Finger Screw. N.O.S.	3	1909-25	4.50 ea.
3340	Transmission Clutch Spring. (Good used)	1	1909-27	12.95 ea.
3339	<b>NEW</b> Clutch Gap Tool. Used to adjust the three clutch fingers on the back of the transmission.	1		13.95 ea.
3340-N	Transmission Clutch Spring. New. Ideal for Watts, Turbo & Ford Clutches. Provides 110- 115 #'s of force at 2" compression length.	1	1909-27	34.95 ea.
3344	Transmission Clutch Shift.	1	1909-27	12.95 ea.



3278-S



3304



3309



3313



3314-1/2



3314-D



3315-STD



3328



3328/9



3329



3336



3340



All prices listed in catalog subject to change. Call for current prices.

Part #	Description	Reqd.	Years	Price
<b>Transmission Cover</b>				
3363	Transmission Cover Front Felt Strip.	1	1909-27	.95 ea.
3367-BS	Trans. Cover Door Screw Set. (6 per set)	1	1912-27	1.50 set
3369	Universal Ball Cap. Front. Spun alloy babbitt.	1	1909-27	62.95 ex.
3369-A	Sealed Ball Bearing 4th Main Cap. Reduces vibration & crankshaft fatigue. Engine disassembly & machining required. Instructions included. No core needed.	1	1909-27	109.95 ea.
3369-S	Special Sealed Bearing 4th Main Cap. Works like #3369-A except no disassembly required. Can be installed with engine in car. Instructions included.	1	1909-27	146.95 ea.
3377-B	Transmission Cover Gasket. (2 pc. set)	1	1909-27	3.95 set
3379-B	Transmission Cover Door Gasket.	1	1911-27	1.00 ea.
3380	Starter Drive Cover.	1	1919-27	11.95 ea.
3381	Starter Drive Cover Gasket.	1	1919-27	.50 ea.
<b>Transmission Control &amp; Bands</b>				
3403	Clutch Lever Screw & Nut Set. Fits #3402. Used to adjust clutch release travel.	1	1909-27	1.00 set
3405	Clutch Lever Pin & Clutch Release Fork Pin.	1	1909-27	.30 ea.
3411	Clutch Lever Clevis Pin. Fits #3402-D.	1	1913-27	.25 ea.
3414-C	Quick Change Ear. Used.	3	1926-27	8.95 ea.
3415	Transmission Band Washer.	2	1909-27	1.25 ea.
3416-BK	Wear-Ever Kevlar Band Lining w/ Rivets & Instructions. (3 pc. set)	1	1909-25	97.50 set
3416-DK	Wear-Ever Kevlar Band Lining w/ Rivets & Instructions. (3 pc. set)	1	1926-27	105.00 set
3416-SR	Band Lining Rivet Set. (set of 24 pcs.)	1	1909-27	1.25 set
3416-W	Transmission Band Adjusting Wrench & Holder. Chained together to prevent loss.	1	1909-27	18.95 ea.
3419	Slow Speed Adjusting Screw & Special Nut.	1	1909-25	11.95 ea.
3419-B	Slow Speed Adjusting Screw & Special Nut.	1	1926-27	11.95 ea.
3420	Transmission Band Adjusting Screw Nut.	1	1909-27	1.00 ea.
3425-S	Transmission Band Springs. (Set of 3)	1	1909-27	2.95 set
3426	Transmission Band Adjusting Nut.	2	1909-27	1.65 ea.
<b>Transmission Pedal &amp; Controller Shaft</b>				
3434-B	Lettered Pedal B with Weld on Head Only. Made of ductile iron.	1	1909-15	12.95 ea.
3434-C	Lettered Pedal C with Weld on Head Only. Made of ductile iron.	1	1909-15	12.95 ea.
3434-R	Lettered Pedal R with Weld on Head Only. Made of ductile iron.	1	1909-15	12.95 ea.
3437	Brake & Reverse Pedal Support Bolt.	2	1909-25	1.75 ea.
3437-B	Support Bolt Nut. Also fits #2514-C.	1	1909-27	.50 ea.
3437-C	Brake & Reverse Pedal Support Bolt.	2	1925-27	2.95 ea.
3439-ES	Pedal Pads. Lettered black rubber. (Set of 3)	1	1909-25	9.95 set
3439-LS	Pedal Pads. Lettered black rubber. (Set of 3)	1	1926-27	9.95 set
3441	Brake & Clutch Pins. (Set of 3)	1	1909-27	.75 set



All prices listed in catalog subject to change. Call for current prices.

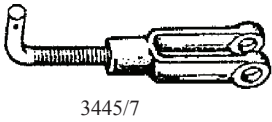

3445/7



3448



3458

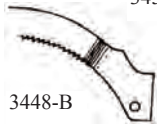

3448-B



3463-RE



3470/71



3500-C



3504



3509



3511



3517/19



3517/19B

Part #	Description	Reqd.	Years	Price
3445/7	Slow Speed Connector & Clevis. (2 pc. set)	1	1909-27	9.95 set
3447	Slow Speed Connector Clevis. (Also for brake rods.)	1	1909-27	6.95 ea.
3448	Brake Quadrant. 4 hole style. Die stamped steel. Made in USA.	1	1909-25	12.95 ea.
3448-B	Brake Quadrant. 2 hole style. Die stamped steel. USA.	1	1926-27	12.95 ea.
3458	Handbrake Lever Pawl. Die stamped steel. Made in USA.	1	1909-27	5.95 ea.
3459	Hand Brake Lever Pawl Pin.	1	1909-27	.75 ea.
3463	Hand Brake Spring. Tempered steel.	1	1909-27	1.95 ea.
3463-RE	Hand Brake Lever Spring. Snap-on. Extra replacement type.	1	1909-27	1.50 ea.
3466	Hub Brake Lever Pins. (Set of 2)	1	1909-27	.75 set
3468-B	Rear Brake Rods. (Requires 2 #3447 clevis (not included))	1	1909-25	73.50 pr.
3468-C	Rear Brake Rods. Requires 2 #3447 clevis (not included)	1	1926-27	36.95 pr.
3470/71	Brake Rod Support Brackets. Brackets attach to rear radius rods & support brake rods to rear brake levers Right & left w/hardware.	1	1914-27	19.95 pr.

## Steering

3500-C	Steering Column Support w/ Grooved Lower Clamp for Horn Wire. This rivets to dash panel.	1	1922-25	79.95 ea.
3500-CB	Steering Support Lower Half with Groove for Horn Wire.	1	1922-25	9.95 ea.
3504	Steering Gear Cover. Solid brass.	1	1909-14	32.95 ea.
3509	Steering Gear Quadrant. Polished brass.	1	1909-14	32.95 ea.
3511	Steering Wheel Nut. Low crown. Polished brass.	1	1909-16	7.50 ea.
3511-B	Steering Wheel Nut. High type. Black oxide.	1	1917-27	2.95 ea.
3511-C	Steering Wheel Nut. High type. Chromed.	1	1917-27	8.95 ea.
3517/19	Steering Pinion Gears & Pins w/ Drive Pinion Shaft. 4 to 1 Ratio. (7 pc. set) (Will not interchange with 1926-27)	1	1909-25	69.95 set
3517/19B	Steering Pinion Gears & Drive Pinion Shaft with Pins. 5 to 2 Ratio. (7 pc. set) (Will not fit earlier gear case).	1	1926-27	69.95 set
3518	Steering Pinion Gear Pin Set. Holds #3517 gears on steering post #3516. (3 pc. set)	1	1909-27	2.25 set
3520	Steering Drive Pinion Gear Key. Stainless.	1	1909-27	1.00 ea.
3523	Steering Gear Post Castle Nut. (Also fits radius rod bolt)	1	1909-27	.75 ea.
3526	Spark & Gas Rod Knobs. Early years only.	1	1909-14	22.50 pr.
3527	Spark & Throttle Rod Springs.	1	1909-27	1.00 pr.
3528-S	Spark & Gas Rod Spring Cups. USA.	1	1909-27	5.50 pr.
3529	Spark & Gas Lever Pins. USA.	1	1929-27	.50 pr.
3530	New Bronze Spark Lever Arm. All holes drilled.	1	1909-27	8.95 ea.
3531	New Bronze Throttle Lever Arm. Holes drilled.	1	1909-14	9.75 ea.
3531-A	Bronze Throttle Lever Arm. Holes drilled.	1	1915-27	8.95 ea.
3532-B	Spark & Throttle Rods Guide. Die stamped. Fits approximately midway of firewall and steering bracket.	1	1916-27	5.95 ea.

All prices listed in catalog subject to change. Call for current prices.

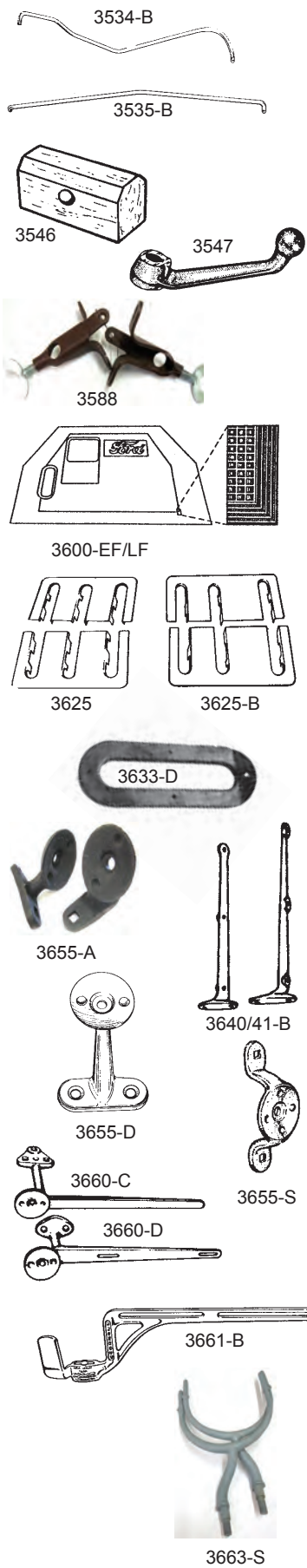

Part #	Description	Reqd.	Years	Price
<b>Steering</b>				
3534-B	Commutator Pull Rod. Non-ball joint type.	1	1912-25	4.95 ea.
3534-C	Commutator Pull Rod.	1	1926-27	4.95 ea.
3535	Carburetor Pull Rod.	1	1909-25	3.50 ea.
3535-B	Carburetor Pull Rod. Non-vaporizer carb. (All except Fordor Sedans)	1	1926-27	4.95 ea.
3540	Steering Gear Bracket Long Bolt & Nut. Used with 2 #3541.	2	1909-27	1.25 ea.
3541	Steering Gear Bracket Short Bolt & Nut. Used with #3540.	2	1911-27	1.95 ea.
3544	Steering Bracket Felt Washer.	1	1909-27	.60 ea.
3545-A	Steering Bracket Bushing. Large bushing used from 1909-21. Often uses 2.	1	1909-25	5.95 ea.
3545-B-2	Steering Bracket Bushing.	1	1926-27	4.95 ea.
3546	Steering Bracket Block. Hardwood.	1	1909-27	1.75 ea.
3547	Pitman Arm. Replaces that worn steering arm & improves steering. USA.	1	1909-27	46.95 ea.
3548	Steering Gear Ball Arm Key.	1	1909-27	.50 ea.
3588	Top Bow Clamps w/ Wing Screws. Holds top to windshield posts.	1	1923-27	49.95 pr.

## Floor Mats













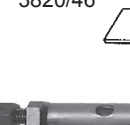

These Floor Mats are of the same design that was on the car when it left the factory. All are made of high quality heavy rubber with a sharp design. Mats have large borders to fit all styles.

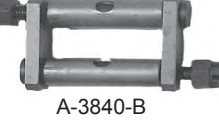
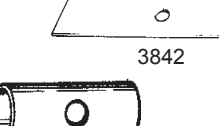
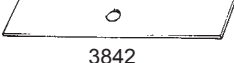
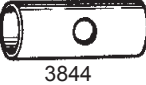
3600-AF	Front Floor Mat. Open Car.	1	1909-14	34.50 ea.
3600-EF	Front Floor Mat. Open Car.	1	1915-25	59.95 ea.
3600-LF	Front Floor Mat. Open Car.	1	1926-27	49.95 ea.
3610-ER	Rear Floor Mat. Open Car.	1	1915-25	42.95 ea.
3610-LR	Rear Floor Mat. Open Car.	1	1926-27	37.95 ea.

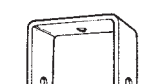
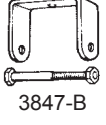
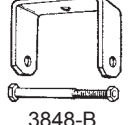
## Brackets

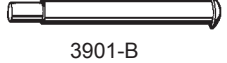
3625	Pedal Floor Board Trim.	1	1909-25	17.95 pr.
3625-B	Pedal Floor Board Trim.	1	1926-27	18.95 pr.
3633	Floorboard Trim Plate for Emergency Brake Handle.	1	1909-25	2.95 ea.
3633-D	Emergency Brake Trim Plate. Correct front angle.	1	1926-27	3.75 ea.
3640/41-B	Firewall Brackets. Wood firewall to frame.	1	1911-16	89.95 pr.
3655-A	Side Light Brackets. Designed for use with oil side lights on Open Cars & Roadster Pickups. USA.	1	1923-25	28.95 pr.
3655/6	Oil Lamp Brackets. Steel. Used with lamps that have blade type mounting brackets. Has round bolt holes.	1	1911- mid '14	34.95 pr.
3655-D	Side Light Brackets for Truck & Depot Hack.	1	1916-27	54.95 pr.
3655-S	Side Light Brackets for Sedan & Coupe.	1	1916-27	49.95 pr.
3660	Tail Lamp Bracket. Roadster.	1	1909-14	16.95 ea.
3660-B	Tail Lamp Bracket. Touring.	1	1913-14	17.95 ea.
3660-C	Tail Lamp & License Bracket. Touring.	1	1915-19	31.50 ea.
3660-D	Tail Lamp & License Bracket. Roadster.	1	1915-19	29.95 ea.
3661-B	Neverout Bracket. Solid brass.	1	1909-14	105. ea.
3663-S	Carbide Headlight Forks. High quality castings. 6-1/2" between forks. Incl. hardware.	1	1911-14	89.95 pr.

All prices listed in catalog subject to change. Call for current prices.

Part #	Description	Reqd.	Years	Price
<b>Front &amp; Rear Springs</b>				
 3811	Front Spring Center Bolt & Nut. 7 leaf size.	1	1909-25	1.00 ea.
3811-C	Front Spring Center Bolt & Nut. 8 leaf size.	1	1926-27	1.00 ea.
 3813-B	Front Spring Shackle Set. L style. For 1 front end.	1	1909-27	39.95 set
3815	Castle Nut Set. Used with front & rear shackles. (8 pcs.).	1	1909-27	2.50 set
 3817-B	Front & Rear Spring Hanger Oiler. Brass. Screw-in turn type. Fits front & rear spring hangers & spindle bolt & tie rod bolt.	4	1909-16	11.95 ea.
3817-N	Front & Rear Spring Hanger Oiler. Nickel plated. Screw-in turn type.	4	1915-16	4.95 ea.
 3818-B	Front Spring Perch. Right hand. Exact duplicate. Made in USA.	1	1919-27	38.95 ea.
 3819-B	Front Spring Perch. Left hand. Exact duplicate. Made in USA.	1	1919-27	38.95 ea.
 3820	Front Spring Perch Bushing.	4	1909-27	.40 ea.
3820/46	Front Shackle Bushings & Oilers. (8 pc. set)	1	1909-27	7.95 set
 3821-B	Front Spring Perch Special Nut.	2	1919-27	5.75 ea.
3823	Front Spring Pad.	1	1909-27	1.00 ea.
 A-3840-B	Rear Spring Center Bolt w/ Nut. Square head. 8 leaf size.	1	1909-27	1.50 ea.
 3838-B	Rear Spring Center Bolt w/ Nut. Square head. 9 leaf size.	1	1922-27	1.50 ea.
 3840-B	Rear Spring Shackle Set. L style. For 1 rear end.	1	1909-27	35.95 ea.
3842	Rear Spring Pad.	1	1909-27	1.25 ea.
 3844	Rear Spring Bushing.	4	1909-27	.70 ea.
3844/46	Rear Shackle Bushings & Oilers. (8 pc. set)	1	1909-27	9.95 set
 3846	Spring Perch Oiler. Flip top type. Cadmium plated.	4	1917-27	2.00 ea.
 3847-B	Front Spring Clamp Set w/ Bolts & Nuts.	1	1909-27	3.95 set
 3848-B	Rear Spring Clamp Set w/ Bolts & Nuts.	1	1909-27	6.95 set
<b>Starting Crank</b>				
3901-B	Crank Handle & Pin. Aluminum. Duplicate of original.	1	1911-14	19.95 ea.
 3903	Starting Crank Handle Sleeve.	1	1909-22	2.95 ea.
3905	Starting Crank Ratchet Pin.	1	1909-27	.75 ea.
 3905-SN	Quick Change Crank Pin. Accessory pin that holds ratchet on crank. Just unsnap to remove ratchet for easy belt change.	1	1909-27	6.95 ea.
3908	Crank Spring.	1	1909-27	.50 ea.
 3909	Starter Crank Handle Spring.	1	1915-22	.50 ea.
<b>Radiator</b>				
 3924	Radiator Filler Neck. Solid brass, 2-1/2" tall. Used 1911-16, also on 1909-10 radiators. Threaded for any 'T' radiator cap.	1	1909-16	32.95 ea.
 3926	Radiator Cap. Brass. High fin.	1	1909-12	18.00 ea.
3926-B	Radiator Cap. Polished Brass.	1	1913-16	9.95 ea.
3926-C	Radiator Cap. Chromed.	1	1917-27	19.50 ea.
3927	Radiator Cap Gasket.	1	1909-27	.25 ea.
3927-R	<b>NEW</b> Rubber Radiator Cap Gasket.	1		1.95 ea.

Part #	Description	Reqd.	Years	Price
<b>Radiator</b>				
3932	Radiator Rod. Threaded. 23" long. (Cut to size)	1	1909-27	5.35 ea.
3939	Water Pipe on Side of Engine. Black Powder Coated.	1	1909-27	9.95 ea.
3939-WP	Water Pipe. Special length pipe for Model T with water pump. (Not used w/ our 3950).	1	1910-27	8.95 ea.
3940-OS	Radiator Drain Petcock, Leakproof. Solid brass. Exact duplicate. USA. (Also used as 2908 gas sediment bulb & 3079 crankcase oil measure).	1	1909-27	13.95 ea.
3944-R	Radiator Hose Set, Red. Heavy duty. (3 pcs.)	1	1909-27	16.95 set
3945-S	Radiator Hose Clamp Set. Original type & style. Galvanized. (6 pc. set)	1	1909-31	6.95 set
3947-MB	Radiator Shell, Black. Modern style. Fits stock radiator & all short Walker radiators. Includes a custom lower valance. <i>Not a stock shell.</i>	1	1917-23	179.95 set
3947-MC	Radiator Shell, Chrome. Modern style. Same as above only chrome.	1	1917-23	229.95 set
3950	Leakless Water Pump Assembly w/ Sealed Bearings & Stainless Steel Components. Includes thermostat, lower hose, gaskets, and easy instructions. No modifications.	1	1909-27	310.00 ea.
3952	Water Pump Packing. Teflon rope strip. (Cut in single rings & stagger joints when installing.)	1	1909-27	2.95 ea.
3954	Thermostat. For use with a water pump. 180 dg. Fits between water outlet & head.	1	1909-27	9.95 ea.
3956	Thermostat. For engines without a water pump. 160 dg. Fits between water outlet & head.	1	1909-27	9.95 ea.
3961-C	Fan Blade Assembly. Stamped steel 4 blade fan. Fits 3962-B fan hub. Black powder coated.	1	1920-27	14.95 ea.
3962-A	Fan Hub Ball Bearing Insert Unit. Replaces original bushings w/ permanently lubricated ball bearings. No modifications. Instructions incl.	1	1916-19	46.50 ea.
3962-B	Ball Bearing Fan Hub Assembly. New. Permanently lubricated sealed ball bearings. Correct contour & raised edges extends fan belt life. No modifications. Instructions incl.	1	1920-27	76.50 ea.
3963-A	Crankshaft Pulley. Small size. Raised edges & correct crown for positive fan belt control. Special spring pin & instructions included. No modifications required.	1	1909-19	62.50 ea.
3963-B	Crankshaft Pulley. Large size. Raised edges & correct crown for positive fan belt control. Special spring pin & instructions included. No modifications required.	1	1920-27	72.50 ea.
3964	Fan Belt, 23". 1 pc. 5 ply construction.	1	1909-16	18.95 ea.
3964-B	Fan Belt, 25-7/8". 1 pc. 5 ply construction.	1	1917-20	19.95 ea.
3964-BL	<b>NEW</b> Fan Belt, 25-7/8". Leather.	1		30.00 ea.
3964-C	Fan Belt, 27". 1 pc. 5 ply construction.	1	1920-25	12.50 ea.
3964-CL	<b>NEW</b> Fan Belt, 27"	1		30.00 ea.
3964-D	Fan Belt, 31". 1 pc. 5 ply construction. Fits 1909-16 w/ water pump	1	1909-16	10.95 ea.

All prices listed in catalog subject to change. Call for current prices.



3939



3940-OS

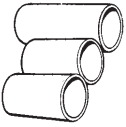

3944-R



3945-S



3950



3956



3961-C



3962-A



3962-B



3963-A



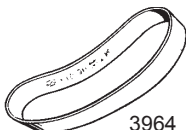

3963-B



3964

All prices listed in catalog subject to change. Call for current prices.

Part #	Description	Reqd.	Years	Price
<b>Radiator</b>				
3964-E	<b>NEW</b> Fan Belt, 28-3/4"	1		10.95 ea.
3964-F	Fan Belt, 32". 1 pc., 5 ply construction. (Also fits 1917-25 w/ water pump)	1	1926-27	10.95 ea.
3964-FL	<b>NEW</b> Fan Belt, 32"	1		31.00 ea.
3964-F	Fan Belt, 32". 1 pc., 5 ply construction. (Also fits 1917-25 w/ water pump)	1	1926-27	10.95 ea.
3964-G	Fan Belt, 33-3/4". 1 pc. 5 ply construction. Fits 1917-27 with various pulley sizes.	1	1917-27	10.95 ea.
3964-L	<b>NEW</b> Fan Belt, 23"	1		30.00 ea.
3964-F	Fan Belt, 32". 1 pc., 5 ply construction. (Also fits 1917-25 w/ water pump)	1	1926-27	10.95 ea.
3964-WP	Fan Belt, 36". For cars with water pumps. 1 pc. 5 ply construction.	1	1926-27	12.95 ea.
 3966	Fan Shaft. Hardened & ground. Correct threaded end. (4-1/4" O.A.)	1	1909-20	17.95 ea.
3966-B	Fan Shaft. Hardened & ground. Correct threaded end. (3-3/4" O.A.)	1	1920-25	19.95 ea.
 3966-C	Fan Shaft. Hardened & ground. Correct threaded end. (4-3/8" O.A.)	1	1926-27	21.95 ea.
3967-B	Fan Bracket. (Good used).	1	1917-25	6.50 ea.
3968	Fan Bracket Mounting Bolt.	1	1909-25	4.50 ea.
3973	Fan Adjustment Bolt & Nut.	1	1909-25	1.25 set
3974-B	Fan Pulley Bushings, Oilite. Front & rear.	1	1920-27	7.50 pr.
 3975	Radiator Mounting Kit w/Leather Pads. Early style.	1	1909-16	14.95 kit
3975-SA	Radiator Mounting Kit.	1	1917-25	16.95 kit
 3975-SB	Radiator Mounting Kit. (18 pcs.)	1	1926-27	17.95 kit
3977	Radiator Front Splash Apron.	1	1923-25	28.95 ea.
 3977	Radiator Front Splash Apron.	1	1923-25	28.95 ea.
3977-A	Radiator Apron. Low style, plain steel.	1	1916-23	54.95 ea.
3977-D	Radiator Apron Trimstrip. Chrome.	1	1926-27	18.95 ea.
 A-3977-D	Radiator Front Splash Apron. As original. Includes crank handle guide & slots for 3977-D chrome trim strip.	1	1926-27	42.95 ea.
3977-E				
3981	Fan Pulley Gasket.	1	1920-27	.35 ea.
3982	Fan Shaft Cap & Felt Washer Set.	1	1920-27	1.25 set
3983	Fan Shaft Felt Washer.	1	1920-27	.50 ea.
<b>Muffler</b>				
 4025	Muffler w/ Cast Iron Ends. Take apart style. Our own product. Made in Ohio.	1	1909-27	59.95 ea.
4025-B	Muffler w/Stamped Steel Ends. Take apart style. Made in Ohio.	1	1909-27	37.95 ea.
4037-B	Exhaust Pipe. Aluminized steel to reduce rusting.	1	1909-27	25.95 ea.
 4025-B				
<b>Hood</b>				
4050-G	Hood. Steel with steel handles. 6 louvers. High type. For vehicles w/ cowl width of 28". (Also fits 1924-27 TT trucks) [side panel 14" at rear & 13 1/2" at front]	1	1924-27	399.95 ea.

All prices listed in catalog subject to change. Call for current prices.

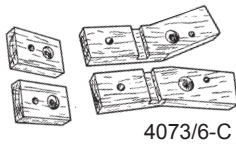
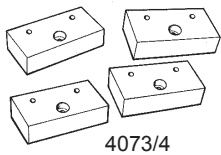
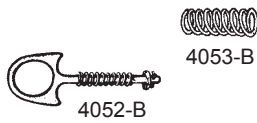
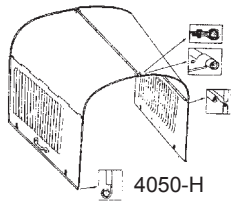

Part #	Description	Reqd.	Years	Price
<b>Hood</b>				
4050-H	Hood. Steel. 18 louvers, Steel handles. (Not for TT Trucks) [side panel 14 3/4" at rear & 14 1/4" at front]	1	1926-27	399.95 ea.
4052-B	Hood Hook w/ Spring. Cast steel.	4	1917-27	5.95 ea.
4053-B	Hood Clip Spring.	4	1917-27	.50 ea.
4056/57	Wooden Hood Blocks. Early cars used wooden blocks for the hood to rest on. We provide solid cherry for the early "T."	1	1909-16	59.95 pr.
4056/57-B	Hood Blocks. Die Stamped Steel. Fits low hood.	1	1917-23	59.95 pr.
4056/57-C	Hood Blocks. Die stamped steel. High hood.	1	1923-25	59.95 pr.
4056/57-D	Hood Blocks. Die stamped steel.	1	1926-27	42.95 pr.
4060-S	Radiator Shell & Cowl Lacing w/ Rivets. 12' long x 1/8" x 3/8" wide.	1	1909-25	9.95 set
4060-XS	Radiator Shell & Cowl Lacing w/ Rivets. 3/8" & 5/8" wide.	1	1926-27	8.95 set
4073/4-B	Hood Block Support. Drilled & counter bored hardwood. (4 pc. set)	1	1924-25	11.95 set
4073/6-C	Hood Block Support. Drilled & counter bored hardwood. (4 pc. set)	1	1926-27	19.95 set

## Carburetor—Miscellaneous

4129	Carburetor Control Rod w/ Brass Knob.	1	1909-16	31.95 ea.
4129-A	Carburetor Adjusting Rod.	1	1909-25	4.95 ea.
4129-B	Carburetor Adjusting Rod & Knob. 31-1/4" long. Cut to fit. All bodies.	1	1925-27	19.95 ea.
4131	Carburetor & Vaporizer Adjusting Rod Sleeve. Used with #4132, #6161-B & #6213-B.	1	1925-27	14.95 ea.
4132	Universal Joint Spider Swivel. Cast metal. Fits. #6213-B, #6279 & #4133. Oversize to compensate for wear.	1	1925-27	1.50 ea.
4133	Carburetor Adjusting Swivel & Needle. For NH carburetors.	1	1926-27	32.95 ea.
4134	Carburetor to Manifold Flange Gasket.	1	1909-27	.30 ea.
4431	Choke Wire. Brass. Through radiator to choke lever.	1	1909-27	2.50 ea.
4582	Carburetor Hot Air Pipe.	1	1912-25	12.95 ea.
4583	Priming Bell Crank.	1	1919-25	4.50 ea.
4588-B	Carburetor Choke Rod & Knob. 13-9/16" long.	1	1919-22	6.95 ea.
4588-D	Carburetor Choke Rod & Knob. 13-1/16" long. Used with steel dash.	1	1923-25	6.95 ea.
4588-E	Carburetor Choke Rod & Knob. 17-1/8" long. Used with steel dash.	1	1923-25	6.95 ea.
4588-F	Carburetor Choke Rod & Knob. 16-1/16" long. Tudor & Fordor Sedan.	1	1923-25	6.95 ea.
4591	Choke Lift Sleeve. Fits carb. rod under hood.	1	1925-27	2.95 ea.

## Fender Brackets

8786-R	Right Fender to Tail Lamp Bracket. Bracket used when mounting above light on right rear fender.	1	1925-27	10.95 ea.
4804-BS	Rear Fender Bracket to Frame Bolt Set. (18 pc. set)	1	1909-25	8.95 set

All prices listed in catalog subject to change. Call for current prices.

Part #	Description	Reqd.	Years	Price
--------	-------------	-------	-------	-------

## Fender Brackets



4806-B	Fender Eye Bolt & Nut.	4	1909-25	10.95 ea.
4850-BS	Front Fender Bracket to Frame Bolt Set. (18 pc. set)	1	1909-25	8.25 set
4858	Front Fender Brackets.	2	1926-27	36.95 ea.



## Running Boards

4811	Running Boards. Torpedo style. Trophy quality.	1	1910-11	160.00 pr.
4812	Running Boards. Rib style. Trophy quality.	1	1909	199.95 pr.
4812-A	Running Boards. Die stamped. Trophy quality.	1	1911-12	199.95 pr.
4812-B	Running Boards. Die stamped. Trophy quality.	1	1913-25	199.95 pr.
4812-C	Running Boards. Die stamped. Trophy quality.	1	1926-27	199.95 pr.
4812-SP	Running Board Step Plates. Rectangular script area. Die cast aluminum. USA.	1	1915-27	47.95 pr.
4812-B				
4813-BS	Special Bolt Set. Running boards to brackets.	1	1909-27	3.95 set
4814-L/R	Running Board Splash Aprons. Open Car.	1	1915-16	195.95 pr.
4815-CL/R	Running Board Splash Aprons. Roadster, Touring, Coupe, Sedan.	1	1917-25	229.95 pr.
4815-FL/R	Running Board Splash Aprons. Fits all body styles.	1	1926-27	229.95 pr.
4822-A1	Running Board Blocks. As original. Drilled hardwood. (Set of 4)	1	1909-25	6.95 set
4822-A2	Running Board Blocks. As original. Drilled hardwood. (Set of 4)	1	1926-27	14.95 set

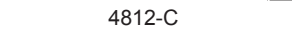
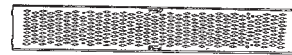

## Ignition Coil

5001	Copper Coil Box Contact Strip Set. (9 pcs)	1	1915-27	16.95 set
5001-A	Coil Box Interior Wood Set. Plywood, drilled & grooved.	1	1915-25	13.95 set
5001-AM	Modern Plastic Coil Box Kit. Not affected by moisture putting an end to misfiring. Hardware included.	1	1915-25	44.95 kit
5001-B	Coil Box Interior Wood Set. Plywood, drilled & grooved.	1	1926-27	11.95 set
5001-BM	Modern Plastic Coil Box Kit. Not affected by moisture putting an end to misfiring. Hardware included.	1	1926-27	44.95 kit
5004	Coil Box Lid. Used on all slant top coil boxes. Die stamped steel. Ford script.	1	1915-25	34.95 ea.
5004-B	Coil Box Lid w/ Latch Clips. Stamped steel. Fits Passenger Cars & Trucks.	1	1926-27	29.95 ea.
5004-AM				
5004-G	Rubber Water Gasket for Coil Box Lid.	1	1926-27	2.50 ea.
5005	Coil Box Tube. Renew that old coil box with all new, white coil box tubes. U.S.A.	1	1914-27	1.35 ea.
5005-L	Coil Box Bolts & Nuts. Copper plated steel. Set includes 10 bolts & 20 nuts.	1	1909-25	4.50 set
5005-S	Coil Box Bolt Set. Copper plated steel. Set has 10 bolts & 20 nuts. Fits later box.	1	1926-27	4.50 set
5005-TN	Thumb Nut. Brass nut used to attach wires to the coil box.	1	1909-13	1.10 ea.
5005-W	Coil Box Tube Insulator Washers. Fiber insulating washers for the tubes & bolts that connect the wiring to the coil box (20 pcs.)	1	1909-27	2.75 set

5001



5001-A

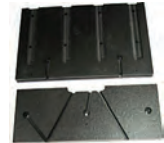

5004-AM

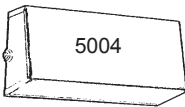

5004

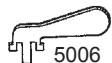

5006



5004-B



All prices listed in catalog subject to change. Call for current prices.

Part #	Description	Reqd.	Years	Price
<b>Ignition Coil</b>				
5006	Coil Box Ignition Key. Flat style. Brass. Die stamped.	1	1914-22	3.95 ea.
5006-P	Early Coil Box Key. The pin style key for early switch that mounts on front of coil box.	1	1909-14	4.95 ea.
5007	Coil Unit. Genuine K. W. Moisture proof case.	4	1914-27	110.00 ea.
5007-C	Coil Capacitor. Internal capacitor of correct capacity used when rebuilding KW coils. USA.	1	1909-27	3.95 ea.
5007-KWS	Wood Cased KW Coil with Thumb Screw Connectors. These coils are ideal for Hit & Miss engines and Flame Throwers.	1	all	89.95 ea.
5007-R	Reconditioned Wood Coils. <i>Exchange only.</i> All coils are cleaned, new capacitor installed, re-potted, new points & hardware and finally-fine tuned.		1909-27	59.95 ea.
5007-WR	Wood Cased KW Coil. High quality wood case stamped KW. Made in USA. The coil has been precisely adjusted on a hand cranked magneto tester. (Tampering w/ coil adjustment voids warranty).		1913-27	79.95 ea.
5008/9	Coil Points. Genuine K W. (2 pc. set)	4	1914-27	11.95 set
5012	Ignition Switch Assembly with Keys. Painted black. (Ammeter not included).	1	1919-25	82.50 ea.
5012-B	Ignition Switch Assembly with Keys. Chrome plated. (Ammeter not included).	1	1926-27	82.50 ea.
5012-C	Ignition Switch Repair Kit. This kit is for clip style case with tabs to hold the parts in the back of the switch.	1	1919-27	19.95 kit
5012-K	Ignition Switch Repair Kit. This kit is for the pin style case with pins to hold the parts in the back of the switch.	1	1919-27	19.95 kit
5012-T	Ignition Switch Tumbler with 2 keys.	1	1919-27	16.95 kit
5013-B	Switch Key. Ford script. From 51 to 74. <i>Specify.</i>	1	1919-27	7.95 ea.
5013-F	Key Fob, leather. Ford Model T.	1	1909-27	5.95 ea.
5014	Starter Switch. Exact duplicate.	1	1919-27	14.95 ea.
5014-M	Starter Switch & Extension Set. Modern style includes extension to clear floorboards. Trouble free quality product. USA.	1	1919-27	32.95 set
5015	Starter Button Extension. To clear floor board.	1	1919-27	4.95 ea.
<b>Ammeter</b>				
5016	Ammeter 20-20. Exact reproduction. Rugged D'Arsonval movement gives steady readings & extreme accuracy. Ford Script.	1	1919-25	54.95 ea.
5016-B	Ammeter, 20-20. (Requires #5017-D if used in 1919-25 switch plate)	1	1919-27	7.95 ea.
5016-F	Ammeter, 20-20. Ford script. (Requires #5017-D if used in 1919-25 switch plate)	1	1919-27	9.95 ea.
5016-L	Ammeter 20-20. Illuminated. Ford Script.	1	1919-25	62.50 ea.
5016-6V	Voltmeter, Used with Alternator or Heavy Duty Generator. 6 Volt.	1		69.95 ea.
5017-D	Ammeter Adapter Plate. To adapt small ammeter to early dash panel.	1	1919-25	3.50 ea.



5007



5007-KWS

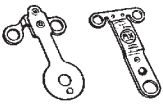

5008/9

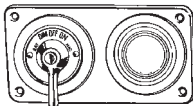

5012

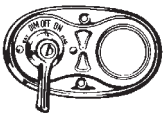

5012-B



5012-C



5013-F

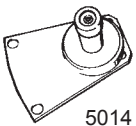

5014



5014-M



5016



5016-L



5017-D

All prices listed in catalog subject to change. Call for current prices.



5018



5019



5022



5023-S

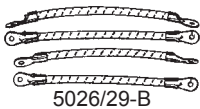

5026/29-B

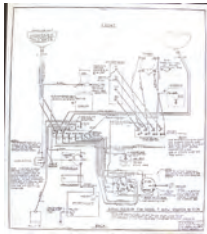

5039

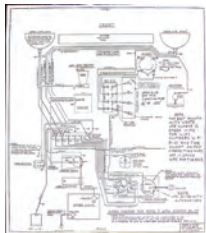

5039-B



5046

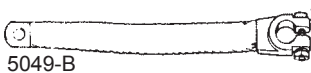

5049-B



5051

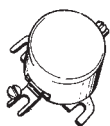

5055

Part #	Description	Reqd.	Years	Price
<b>Ammeter</b>				
5018	Starter Drive Assembly. Complete.	1	1919-27	75.00 ea.
5019	Starter Drive Head.	1	1919-27	7.95 ea.
5020	Starter Drive Key.	1	1919-27	.25 ea.
5021-BG	Bendix Gear with Balance Ring Set. Replaces weakest part of starter drive.	1	1919-27	21.95 set
5021-SL	Starter Bendix Sleeve. Replaces weakest part of bendix drive.	1	1919-27	11.95 ea.
5022	Starter Bendix Spring. USA.	1	1919-27	15.95 ea.
5023-S	Starter Bolt & Washer Set.	1	1919-27	2.50 set
<b>Wiring</b>				
5026/29-B	Spark Plug Wire Set. Oak brown covered wire with brass terminals.	1	1909-25	20.00 set
5026/29-BB	Spark Plug Wire Set. Oak brown covered wire with brass terminals.	1	1926-27	15.95 set
5027	Magneto to Coil Box Wire. Oak brown covered wire with brass terminals.	1	1909-27	4.95 ea.
5029-0	9 mm <b>Bulk</b> Ignition Wire less Ends. Oak/Black Tracer.	1	1909-27	1.50 ft.
5029-B	9 mm <b>Bulk</b> Ignition Wire less Ends. Black/Double Red Tracer.	1	1909-27	1.50 ft.
5029-T	Spark Plug Terminal. Original style brass. U.S.A.	1	1909-27	.60 ea.
5030	Commutator Wire. 5 wire. (Without starter)	1	1909-22	24.95 ea.
5031	Commutator Wire. 7 wire.	1	1919-25	44.95 ea.
5031-B	Commutator Wire. 4 wire.	1	1926-27	21.95 ea.
5033-C	Wire Clip. May need as many as 7 per car.	1	1919-27	1.25 ea.
5038	Ammeter to Switch Wire.	1	1919-27	1.95 ea.
5039	Wiring Diagram. Fully detailed 24" x 28" poster.	1	1919-25	5.95 ea.
5039-B	Wiring Diagram. Fully detailed 24" x 28" poster.	1	1926-27	5.95 ea.
5040/40-B	Horn Wiring Set.	1	1919-27	10.95 set
5041	Lighting Wire Harness. 5 wire.	1	1919-25	37.95 ea.
5041-E	Lighting Wire Harness. 8 wire.	1	1926-27	59.95 ea.
5042	Switch Wire Harness. This 7 wire harness runs from terminal block to back of switch.	1	1919-27	27.95 ea.
5044	Terminal Block with Mounting Bolts.	1	1922-27	8.95 ea.
5046	Battery Cable to Starter Switch. 30" long.	1	1919-27	11.95 ea.
5047-C	Battery Cable to Switch Support Bracket with Grommet.	1	1920-27	4.25 ea.
5049-B	Ground Connector Strap. Braided ground strap with tinned battery terminal. 7" long.	1	1919-27	11.95 ea.
5051	Starter Switch to Starter Motor Cable. 30".	1	1919-27	9.95 ea.
5051-OR	Starter Switch Cable. Cloth covered as original w/correct ends.	1	1919-27	13.95 ea.
5053	Cable Loom. Fits over #5051 starter cable from switch to starter motor.	1	1919-27	5.95 ea.
5055	Generator Cutout Negative ground. Fits on top of generator. Quality foreign product. (Note: Clip goes on side closest to mounting ears. This is arm side).	1	1919-27	54.95 ea.



5055-CK



5055-R



5099



5101



5104-S



5105



5106



5107



5119



5119-A



5122

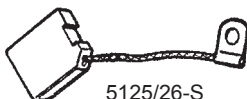

5125/26-S

Part #	Description	Reqd.	Years	Price
<b>Wiring</b>				
5055-CK	12 Volt Conversion Kit. Fits all Model T's with negative ground and 6 volt generator.		All years	99.95 kit
5055-R	Voltage Regulator w/ Ford Script. Negative ground. No more sticking points. (Will not fit model A's or V-8's)	1	1919-27	89.95 ea.
5056	Starter Motor Mounting Gasket.	1	1919-27	.75 ea.
5057	Generator Gasket.	1	1919-27	.75 ea.

## Starter

**Important Notice** Rebuilt Starters and Generators require a re-buildable core. We cannot process your order without receiving a re-buildable core. Gaslight is unable to extend a core charge.

5059-S	Starter Drive Cover Special Screws & Lock Washers. (8 pc. set)	1	1919-27	1.95 set
5062	Starter Motor Mounting Set. (8 pc. set)	1	1919-27	1.50 set
5099	Starter Motor. Rebuilt. <b>Sold exchange only.</b> Complete with all new or refurbished parts. New field coils, bearing, brushes and post kit installed. The armature is turned, polished, ground tested, then growl tested for shorts. Does not include bendix drive.	1	1919-27	279.95 ea.
5101	Coverband with Nut & Bolt. Fits both starter & generator. Duplicate of original.	1	1919-27	8.95 ea.
5104-S	Starter Brush Set. Authentic. (Set of 4)	1	1919-27	15.95 set
5105	Starter Rear Bushing. Drive end. Brass.	1	1919-27	8.95 ea.
5105-S	Modern Starter Seal. Keeps the oil where it belongs. No modifications. Inst. included.	1	1919-27	5.95 ea.
5106	Starter Front Bushing. Brush end. Brass.	1	1919-27	5.95 ea.
5107	Starter Field Coil Set.	1	1919-27	59.95 set
5109	Starter Terminal Outer Insulator.	1	1919-27	2.95 ea.

## Generator

5119	Generator. Rebuilt. <b>Sold exchange only.</b> <b>Remove your gear first.</b> Rebuilt with all new or refurbished parts. New field coils, bearing, brushes and post kit installed. Armature is turned, polished, ground tested and then growl tested for shorts. Negative ground.	1	1919-27	229.95 ex.
5119-A	Alternator. 12 volt. Complete gear driven Delco unit w/ internal fan & regulator. 1 year warranty. No modifications needed. Instructions included. USA.	1	1919-27	239.95 ea.
5119-A6/ 5119-A12	Alternator. 6 or 12 volt. Complete gear driven unit. Simply change the regulator to go from 6 to 12 volt without changing any of your existing wiring. 5 yr. guarantee against defects.	1	1919-27	249.95 ex.
5121	Generator Bearing. Small. Brush end.	1	1919-27	3.95 ea.
5122	Generator Bearing. Large. Gear end. Double shielded.	1	1919-27	3.50 ea.
5125/26-S	Generator Brush Set. (3 pcs.)	1	1917-26	12.95 set
5128	Generator Small Bearing Felt.	1	1919-27	.50 ea.

# Model Parts

All prices listed in catalog subject to change. Call for current prices.

Part #	Description	Reqd.	Years	Price
<b>Generator</b>				
5131-A	Large Brush Holder on End Plate.	2	1919-27	9.95 ea.
5131-B	Small Brush Holder on End Plate.	1	1919-27	9.95 ea.
5132	Insulator for Generator Brush Plate. 2 different insulators as originally used in assembling the generator. USA.	1	1919-27	2.95 pr.
5133	Generator Outer Terminal Insulator.	1	1919-27	2.95 ea.
5136	Generator Gear to Shaft Retaining Pin.	1	1919-27	.50 ea.
5137	Generator Gear.	1	1919-27	19.95 ea.
5143	Generator Field Coil Set. (4 coil set)	1	1919-27	59.95 set
<b>Battery &amp; Spark Plugs</b>				
5150-B	Battery Bracket Assembly. Die stamped steel. Exact duplicate. (Not for TT Truck)	1	1919-27	39.95 ea.
5152	Battery Clamp Set.	1	1919-23	5.95 set
5152-B	Battery Clamp Set.	1	1921-27	7.95 set
5201	Champion #25 Spark Plug. Long reach for model T. 1 piece style.	4	1909-27	19.95 ea.
5201-A	Spark Plug. 1/2" Pipe thread. 1 piece style.	4	1909-27	5.50 ea.
5201-X	Champion X Spark Plug w/ Brass Top as Original. Trophy style required for judging.	4	1909-27	39.95 ea.
5202	Spark Plug Adapters. (4 pc set). Adapts T head to accept 14mm spark plugs.	1	1909-27	14.95 set
<b>Carburetor</b>				
6200-DP	Data Plate w/Pins. Holley NH Carburetor. This plate used before the word Ford was added. (#6200-C & #6200-D.)	1	1919-22	1.95 ea.
6200-DPB	Data Plate for NH & Holley Carburetors. Used on Carbs with both Ford & Holley.	1	1916-27	1.50 ea.
6200-DPV	Data Plate fo Holley Vaporizer.	1	1926-27	4.95 ea.
6200-FV	Fuel Shut-Off Valve. Replaces elbow fitting where gas line connects.	1	1909-27	22.95 ea.
6200-K-L4	Kingston Needle, Seat & Gasket Set for Model L4 Carb. This is ball type seat valve.	1	1921-26	21.95 set
6200KL-4	Kingston L4 Needle Seat & Gasket Set. Has steel needle & seat. Includes all gaskets.	1	1921-26	12.95 set
6200-NH	Gross-jet Needle & Seat with Gasket Set. Provides positive fuel level in your clean carb. Fits' NH or Vaporizer Carbs. <b>State which one.</b>	1	1920-27	26.95 set
6200-NHV	Viton tipped needle & gaskets. Holley NH or Vaporizer Carbs. <b>State which one.</b>	1	1920-27	26.95 set
6201	Carburetor Float w/ Lever. Brass plated. For NH 1 carb. Also fits vaporizer carburetor. (Set float 1/4 " below flange).	1	1920-27	21.95 ea.
6201-G	Cork Float w/ Screws. Use your old hinge. For Holley 'G' carburetor only.	1	1918-20	17.95 ea.
6201-L-2	Cork Float w/ Screws. Use your old hinge. For Kingston L-2 carburetor.	1	1917-21	17.95 ea.
6202-C	Float Chamber Steel Bowl. Center drain style. Holley NH Carburetor.	1	1923-27	7.95 ea.
6203-G	Carburetor Gasket Set for Holley 'G' Carb.	1	1913-21	1.95 set



Part #	Description	Reqd.	Years	Price
<b>Carburetor</b>				
6203-L	Carburetor Gasket Set for Kingston 'L' Carb.	1	1912-21	1.95 set
6203-L4	Carburetor Gasket Set for Kingston 'L-4' Carburetor	1	1921-26	1.95 set
6203-NH	Carburetor Gasket Set for Ford & Holley NH Carburetor.	1	1920-26	1.95 set
6203-V	Carburetor Gasket Set for Holley Vaporizer Carburetor.	1	1926-27	1.95 set
6206-A	Throttle Lever & Brass Shaft with correct adj. screws for NH & Model G Carburetor.	1	1914-23	18.95 ea.
6206-B	Choke Lever & Brass Shaft with Torsion Spring for NH & 'G' Holley Carburetor.	1	1914-23	15.95 ea.
6206-C	Throttle Lever & Brass Shaft with Correct Adjusting Screws for Holley & NH Carburetor.	1	1923-26	18.95 ea.
6206-D	Choke Lever & Brass Shaft with Torsion Spring Attached for NH Carburetor.	1	1923-26	18.50 ea.
6208	Adjusting Needle Clamp Nut for NH Carburetor. Use with #6213.	1	1920-25	4.95 ea.
6208-B	Spray Needle Adjusting Nut for NH & L-4 Carburetors. Use with #6213-B.	1	1925-27	3.95 ea.
6208-H	Spray Needle Clamp Nut. (Used with 6213-G spray needle)	1	1912-19	3.95 ea.
6208-L	Spray Needle Adjusting Nut. Kingston L-4 Carbs. (Used w/#6213-K)	1	1915-26	9.95 ea.
6209	Carburetor Throttle and/or Choke Plate with Retaining Clip for NH Carburetors. Brass.		1920-27	4.25 ea.
6213	Spray Needle Assembly for NH Carburetor #6200-C. Use with #6208 clamp nut.	1	1920-25	9.95 ea.
6213-B	Spray Needle Assembly for NH #6200-D. Use w/#6208-B clamp nut.	1	1925-27	23.95 ea.
6213-G	Ford & Holley "G" Spray Needle Assembly. Made in the USA. Use with 6208-H.	1	1914-21	9.95 ea.
6213-K	Spray Needle Assembly. USA. Kingston L, L2 & Early L4 Carb. Use w/#6208-L nut.	1	1910-25	10.95 ea.
6214-B	Spray Nozzle. NH & Vaporizer Carburetors.	1	1920-27	7.95 ea.
6216/21	Carburetor Drain Valve for NH Carburetor. Non-vaporizer type. Brass.	1	1920-26	13.95 ea.
6216/91	Carburetor Drain Valve for Vaporizer Carburetors. Brass.	1	1926-27	12.95 ea.
6256	Vaporizer Choke Lever Assembly. Brass shaft with black oxidized steel levers. Correct spring is included. USA.	1	1926-27	13.95 ea.
6258-H	Choke Lever Spring. Fits Holley Model G & NH Carburetors.	1	All	1.50 ea.
6257	Vaporizer Choke Plate.	1		3.50 ea.
6258-K	Choke Lever Spring. Fits Kingston L & L-4 Carburetors.	1	All	1.00 ea.
6258-V	Choke Lever Spring. Fits vaporizer car			
6259	Vaporizer throttle lever assembly. Brass shaft with black oxide steel lever & screw. USA.	1	1926-27	8.95 ea.
6260	Vaporizer Throttle Plate.	1		2.50 ea.
6269	Vaporizer Outlet Tube. Brass. Correct flange. USA.	1	1926-27	8.95 ea.
6271	Vaporizer Outlet Tube Brass Knurled Nut. USA.	1	1926-27	4.95 ea.



6206-C



6208

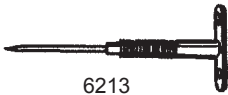

6213



6216/21

All prices listed in catalog subject to change. Call for current prices.

All prices listed in catalog subject to change. Call for current prices.

Part #	Description	Reqd.	Years	Price
<b>Carburetor</b>				
6273	Vapor Heating Plate for Vaporizer Carburetor. Stainless steel. (Raised corrugated area faces engine.) USA.	1	1926-27	2.50 ea.
6276	Vaporizer Primary Air Tube. Stainless. USA. (Tube runs from bowl up to the butterfly plate)	1	1926-27	5.95 ea.
6277	Vaporizer Heating Plate Support. USA. (Coil spring fits around & supports #6276 air tube.)	1	1926-27	1.95 ea.
6278	Vaporizer Adjusting Needle Nut. Machined brass. Used with #6279. USA.	1	1926-27	4.50 ea.
6279	Vaporizer Adjusting Needle Assy. Brass shaft & stainless needle. Used w/ #6278. USA.	1	1926-27	14.95 ea.
6283	Vaporizer Carb. Adjusting Needle Seat. USA.	1	1926-27	6.95 ea.
<b>Lights</b>				
2122-X	Headlight Loom Bushings. Fits hood shelf at front to prevent chafing of wiring.	1	1917-25	3.95 pr.
3158-M	Modern Stop/Brake Light Switch. Heavy duty. This kit will work with 6, 8, & 12 volt systems positive or negative ground.	1	1909-27	36.95 kit
3158-SX	Stop Light Switch. Clamps on starter cover. Authentic duplicate.	1	1919-27	34.95 ea.
5055-CK	12 Volt Conversion Kit. Fits all Model T's with negative ground and 6 volt generator.		All years	99.95 kit
6437-DX	<b>NEW</b> Bracket for Battery Horn. Stamped Steel.		1926-27	13.95 ea.
6405-CX	Glass Tail Lamp. Cup style. Clear glass.	1	1924-27	9.95 ea.
6440-H	<b>NEW</b> Hollywood Wolf Whistle. Die cast alloy vacuum whistle w/fitings & instructions. Operates on manifold vacuum.		1909-27	59.95 ea.
6484-BRX	Tail Lamp Lens. Red.	1	1919-25	6.95 ea.
6484-CX	Tail Lamp Lens. Red celluloid. 2-3/4" dia. Used in 6405-CX.	1	1926-27	1.25 ea.
6574-AX	Headlamp Socket. Exact duplicate. Double contact. Used with generator system.	2	1919-27	14.95 ea.
6575	Electric Headlight Rims. Polished brass.	1	1915-16	57.50 pr.
6575-AX	Electric Headlight Rims. Painted black.	1	1916-25	52.50 pr.
6575-BX	Electric Headlight Rims. Nickel plated.	1	1926-27	57.50 pr.
6575-T	<b>NEW</b> Headlight Rim Removal Tool.		1926-27	32.95 ea.
6576-HX	Headlamp Lens. Ford script. 'H' style. Refracting lens for improved lighting.	2	1915-27	19.95 ea.
6578-X	Headlight Gaskets. Cord style.	1	1915-27	3.95 pr.
6586-X	Headlight Lens Retainer Wire.	2	1915-27	4.50 ea.
6590-AX	Headlamp Reflectors. Chromed steel.	1	1915-27	59.95 pr.
6591-S	Focusing Screws & Springs for #6574-AX. (4 pc. set)	1	1919-27	1.95 set
6592	Headlamp Plug w/ Thimble. Double contact.	1	1915-27	22.50 pr.
6593	Tail Light Plug w/ Thimble. Single contact.	1	1919-27	10.95 ea.
7650	Tail Lamp Wire Bushing Kit. (6 pcs. kit)	1	1919-27	15.95 kit
7669-RX	Tail Lamp Assembly. Electric. Exact duplicate. Made in USA. (Painting required).	1	1919-24	44.95 ea.

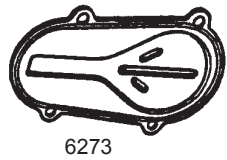

6273



2122-X



6405-CX



6484-BRX

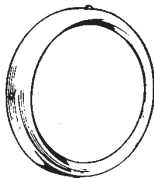

6575



6576-HX

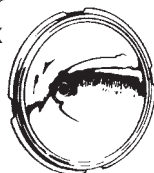

6590-AX



6592



6593

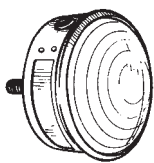

7669-RX

Part #	Description	Reqd.	Years	Price
--------	-------------	-------	-------	-------

## Lights

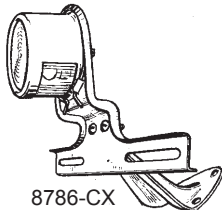

8786-CX



8786-R



8786-TS

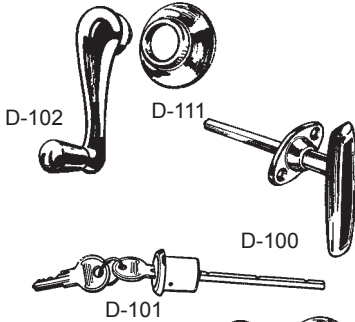

D-102

D-111

D-100

D-101



D-106



D-107



D-112-WF

7948-CTK	<b>NEW</b> Top covering kit. Coupe.		1928-31	149.95 ea.
7950-STK	<b>NEW</b> Top covering kit. Tudor & Fordor Sedan		1928-31	179.95 ea.
8786-CX	Tail Lamp & License Bracket. Complete original style tail light w/ left side fender mounting bracket. (Order 8786-R if mounting on right fender)	1	1925-27	79.95 ea.
8786-R	Right Fender to Tail Light Bracket. Used when mounting above light on right rear fender.	1	1925-27	10.95 ea.
8786-TS	Modern Turn Signal Switch. Using the tail lights to alert drivers behind you. Mounts on spark control lever. 7 wire with 12V flasher. Includes instructions & wiring diagrams.	1	1926-27	149.95 ea.
A-13000	Headlamp Bulb. 50-32 cp. 6 volt. Dbl. contact. The higher candlepower offers better visibility & safety. Ensures other drivers will see you when using the brakes.	2	1919-34	1.25 ea.
A-13000-HAL	Halogen Head Light Bulb. Uses Orig. style base for easy installation.		1919-34	27.00 ea.
A-13465	Stop Lamp Bulb. 21 cp. 6 volt.	1	1926-32	1.10 ea.
A-13465-HP	Brighter Stop/Brake Bulb. 6 volt. 30 cp.	1	1926-42	1.25 ea.
A-13466	Light Bulb. This bulb is used in several places in A., T & V-8 Fords. (Cowl, Dash, Dome, Park & Taillight.) 3 cp. 6 Volt.		1919-36	.95 ea.

## Door Handles & Deck Lock & Key

D-100	Outside Door Handle. Closed Car.		1924-27	29.95 ea.
D-101	Door Lock & Keys. Fits Closed Car.		1924-48	12.95 ea.
D-102	Window Riser Handle. Standard style. Closed Cars.		1924- mid '30	10.95 ea.
D-103	Window Regulator Assy. Right side. 3 hole mounting for steel doors. Coupe & Tudor.		1924-27	36.50 ea.
D-104	Window Regulator Assy. Left side. 3 hole mounting for steel doors. Coupe & Tudor.		1924-27	36.50 ea.
D-105	Door Latch Knob. Closed Car & Truck.		1915-29	4.95 ea.
D-106	Door Garnish Moldings. Coupe & Tudor Sedan.	1	1926-27	124.95 pr.
D-107	Door Bumper Set. Coupe & Tudor Sedan. (10 pcs)		1926-27	7.95 set
D-108	Panel Grommets & Ratchet Nails. Holds door & kick panels in place. (10 nails & 10 grommets per pack) Open Cars & Trucks.	1	1926-29	7.95 pkg.
D-111	Escutcheon Plate. Chromed. Fits behind window riser handle. Closed Car.	1	1923-48	4.50 ea.
D-112-WF	Inside Door Window Frames w/ Brackets & Fittings. 1926-27 Coupe & Tudor & 1927-29 Closed Cab Truck.	1		134.95 pr.
D-114	Felt Glass Channel Strips, 48" long. Closed Car & Truck.	1	1917-29	42.95 pr.
D-115	Door Latch Repair Kit. Contains all springs, screws & rivets needed to repair both door latches. Coupe, Tudor & Closed Cab Truck.	1	1926-27	15.95 kit
D-116	Hinge to Door Hardware. Screws & star washers to fasten three hinges to one door.	1	1926-27	2.95 set

All prices listed in catalog subject to change. Call for current prices.

All prices listed in catalog subject to change. Call for current prices.

Part #	Description	Reqd.	Years	Price
--------	-------------	-------	-------	-------

## Door Handles & Deck Lock & Key



D-117	Hinge to Door Post Hardware. Screws and square nuts to fasten three hinges to one door.	1	1926-27	2.95 set
D-120	Door Latch Assembly. Bent arm type. Right rear only. Open Car Only. USA.	1	1917-25	28.50 ea.
D-122	Door Latch Assembly. Bent arm type. Right front & Left rear. Open Car. USA.	1	1917-25	28.50 ea.
D-123	Dovetails. Male. 4 hole type. Chrome plated. Closed Car & Truck.	1	1924-27	4.95 pr.
D-123-A	Dovetail, Female. 4 hole type. Stamped steel w/mtg. hardware. Fits on door post. Closed Car.	2	1924-27	9.95 ea.
D-123-B	Door Striker Plate with Mounting Hardware. Fits on door post. Closed Car & Truck. (2 pc. set)	2	1925-27	12.95 ea.
D-124	Door Latch Assy. USA. Bent arm style. Left side, front or rear. Open Car only.	1	1926-27	28.50 ea.
D-126	Door Latch Assy. USA. Bent arm style. Right side, front or rear. Open Car only.	1	1926-27	28.50 ea.
D-127	Door Latch. Right Hand. Closed Cars and 1928-29 CC Pickup.	1	1926-27	119.95 ea.
D-128	Door Latch. Left Hand. Closed Cars and 1928-29 CC Pickup.	1	1926-27	119.95 ea.
D-132	Deck Lid Key. (Must be modified to fit 1923-25).	1	1923-27	9.95 ea.
D-136	Deck Lid Lock Assembly.	1	1926-27	24.95 ea.
D-138	Deck Lid Hinges. Roadster only.	1	1926-27	29.95 pr.
D-267	Sun Visor Framework. Fits Coupe & Tudor Sedan. These are sold less covering. See #D-268 Cover Kit.	1	1926-27	98.95 ea.
D-268	Sun Visor Cover Kit. Cobra long grain material matches the top material for a trim appearance of the visor. Closed Coupe & Tudor.	1	1926-27	29.95 kit
D-307	Door Bottom Patch Panels. with Bead. Coupe & Tudor Sedan.	1	1926-27	89.95 pr.
D-308	Door Bottom Inner Patch Panels. Coupe & Tudor Sedan.	1	1926-27	44.95 pr.

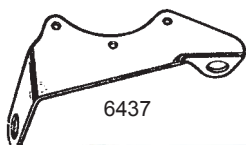

## Horn, Etc.

6432	Horn Assembly w/ Bracket. Negative ground only. 6 volt.	1	1926-27	259.95 ea.
6437	Bracket for Battery Horn. Stamped steel.	1	1917-25	16.95 ea.
6437-DX	Bracket for Battery Horn. Stamped steel.	1	1926-27	10.95 ea.
6440-A	Exhaust Whistle Valve. This unit connects whistle to your exhaust pipe. 'T' is 1-1/2" dia.	1	1909-27	89.95 ea.
6440-B	Exhaust Valve Foot Pedal. Provides easy foot operation of whistle valve.	1	1909-27	48.95 ea.
6440-BR	Brass Exhaust Whistle. This 4 tube <i>Aeromore</i> whistle has authentic brass tubes sounds just like the midnight mail train from Grandpa's day. Great parade fun. Requires 6440-A & 6440-B to work on your 'T'.	1	249.95 ea.	
6440-E	Spark Plug Whistle Kit. A popular and effective warning device using the spark plug explosion to produce a sharp whistle sound. Kit includes whistle, plug adapter, kick pedal & cable.		1909-27	149.95 kit



Part #	Description	Reqd.	Years	Price
<b>Horn, Etc.</b>				
6440-H	<b>Hollywood Wolf Whistle.</b> Die cast alloy vacuum whistle w/ fittings & instructions. Operates on manifold vacuum.		1909-27	49.95 ea.
8028-X	Horn Button Assembly w/ Mounting Clamp.	1	1915-27	34.95 ea.
H-25	Horn Bulb. Black with brass ferrule. 5/8" I.D. x 5-1/4" long x 3-1/4" wide.	1	All	18.95 ea.
H-26	Horn Bulb. Black with brass ferrule. 5/8" I.D. x 6-1/2" long x 4-1/2" wide.	1	All	22.95 ea.
H-27	Mounting Bracket for Brass Horns. For horn bulb & flexible tubing. H-29 fits this threaded end.	1	1910-16	12.95 ea.
H-28	Horn Reed Holder. Brass. Solders to horn. Threaded inside for reed. Threaded outside for H-29.	1	All	7.50 ea.
H-29	Threaded Reed Cover & Bulb Connector. Brass. Screws to H-28. Horn bulb slips over end. Also used with H-27 bracket.	1	All	10.95 ea.
H-30	Brass Reed for Bulb Horn. Threaded to fit H-28.	1	All	12.50 ea.
7824-C	Windshield Glass Clamp. For Open Car.	4	1923-25	4.25 ea.
7824-D	Windshield Glass Clamp. For Open Car.	4	1926-27	4.25 ea.
7831-BRX	Curtain to Windshield Hooks. (Set of 4)	1	1915-27	1.95 set
7853-X	Rearview Mirror. Open Car. Authentic style mounts to top center of windshield frame. Just paint and install.	1	1916-27	46.50 ea.
8320-BX	Door Lever Pads. Closed Car.	1	1922-27	3.50 pr.
18257-X	Windshield Wiper. Hand operated. Chrome plated. Open Car.	1	1910-29	22.95 ea.
18258-BL	Wiper Blade Only for Above. Open Car.	1	1910-29	6.95 ea.
18258-CL	Hand Wiper Clamp Set. Holds #18257-X to any windshield frame without drilling any holes.	1	1910-29	6.95 set



6440-H

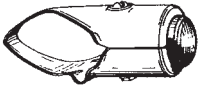

8028-X



H-25/26



7824-C



H-30



8320-BX



18258-CL



## Closed Car Top Parts

**Note: Special Order Items must be prepaid and are non returnable.**

7940-RX	Top Assembly. Bows, hold-down clamps, prop nuts, thumb screws, top bow sockets & rivets; less fabric. Roadster & Roadster Pickup. <b>Specify Year.</b>	1917-27	call for price
7940-TX	Top Assembly. Bows, hold-down clamps, prop nuts, thumb screws, top bow sockets & rivets less fabric. Touring. <b>Specify Year. and 'Colonial or Cobra' Grain Material.</b>	1917-27	call for price

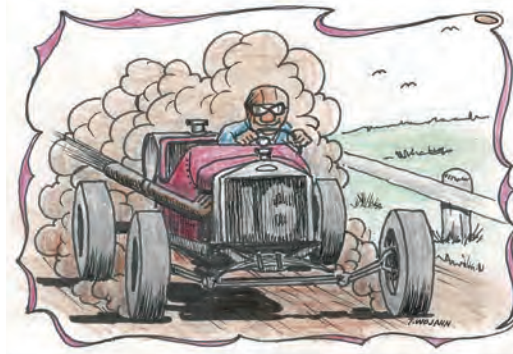

**Race Car Enthusiast**  
Request a list of  
race car accessories  
and dress-up items  
for your race car  
projects.

# Model T Parts

Part # Description Req'd. Years Price



All prices listed in catalog subject to change. Call for current prices.

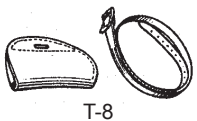
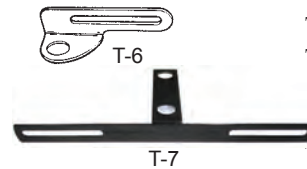
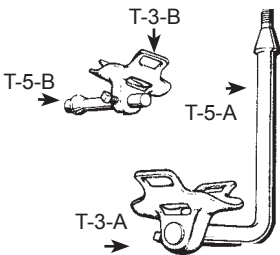
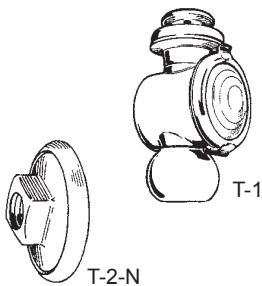

## Model T Accessories

T-1	'T' Style Sidelights with Clear Glass Lens. Cast aluminum. Paint black for authentic look. Non-functional.	1	All	79.95 pr.
T-2	Top Prop Studs. Holds main top bow to body. 15/16" shoulder. Roadster.	1	1925-27	12.95 pr.
T-2-BR	Top Prop Nut. Polished brass. 1-1/2" dia. 7/16" Std. thread.	2	1912 & up	7.95 ea.
T-2-L	Top Prop Studs. Holds main top bow to body. 1-5/16" shoulder. Touring.	1	1925-27	12.95 pr.
T-2-N	Top Prop Stud Nut. Fits T-2. 1-1/2" dia. 7/16" thread. Square nut. Stainless steel.	2	1925-27	10.00 ea.
T-3-A	Top Bow Saddles. 5/8" hole. USA.	1	1913-22	17.95 ea.
T-3-B	Top Bow Saddles. 1/2" hole. USA.	1	1923-29	17.95 pr.
T-4-B	Top Saddle Leather Pads & Straps.	1	1913-29	23.95 pr.
T-5-A	Top Saddle Rods. 5/8" dia. L shape for Roadsters. Overall length 7-5/8".	1	1909-22	15.95 pr.
T-5-AT	Top Saddle Rods. 5/8" dia. L shape for Touring Cars. Overall length 8-7/8".	1	1909-22	15.95 pr.
T-5-B	Top Saddle Rods. 1/2" dia.	1	1923-27	14.95 pr.
T-6	Front License Plate Bracket. Die stamped.	1	1909-20	3.95 pr.
T-7	Front License Plate Bracket. Powder coated.	1	1920-27	5.95 ea.
T-8	Crank Holder & Strap. Black leather.	1	1909-27	11.95 ea.

All prices listed in catalog subject to change. Call for current prices.

Part #	Description	Reqd.	Years	Price
<b>Model T Accessories</b>				
T-9	Transmission Band Changer. Easy extra hand.	1	1909-27	11.95 ea.
T-11	Oil Check Rod. The only way to check oil.		1909-27	6.95 ea.
T-12-B	Flag Holder Set. Complete with 5 American Flags & round adjustable clamp. Brass plated.	1	1909-16	31.95 set
T-12-C	Flag Holder Set. Complete with 5 American Flags & round adjustable clamp. Chrome.	1	1917-25	31.95 set
T-13-B	Dogbone Radiator Cap. Brass. Drilled for motometer.	1	1909-16	28.95 ea.
T-13-C	Dogbone Radiator Cap. Chrome plated brass. Drilled for motometer.	1	1916-27	24.95 ea.
T-14-B	Winged Radiator Cap. Brass. Drilled for motometer. Long wings.	1	1909-16	26.95 ea.
T-14-C	Winged Radiator Cap. Chrome. Drilled for motometer. Long wings.	1	1916-27	32.00 ea.
T-14-CS	Winged Radiator Cap. Chrome. Short wings.	1	1916-27	36.95 ea.
T-14-MB	Brass Motometer. Wreath rim. Ford face.	1	1909-16	49.95 ea.
T-14-MC	Chrome Motometer. Wreath rim. Ford face.	1	1917-27	49.95 ea.
T-15-A	Outside Oil Line with Adapter.	1	1909-25	31.95 ea.
T-15-B	Outside Oil Line.	1	1926-27	26.95 ea.
T-20-B	Ford Script. Polished die cut brass. 7-1/2" x 3-1/4".	1	All	16.95 ea.
T-20-C	Ford Script. Chromed die cut brass. 7-1/2" x 3-1/4".	1	All	19.95 ea.
T-21	Top Bow Side Strap Set. Black leather straps w/ brass pins. Correct 4" length. (2 per set)		1909-16	9.75 set
T-24-RK	Tire Pump Repair Kit. 17 peices except base & metal pump body. Accurately duplicated to fit all T' tire pumps with stamped steel or cast iron base. Wood handle, hose w/clamp, leather diaphragm, top cap, spring, etc.	1	1922-27	22.95 kit
T-26	Round Hind View Mirror. Brass.	1	1909-15	42.50 ea.
T-26-C	Round Hind View Mirror. Chromed.	1	1916-27	42.50 ea.
T-29	Dash to Windshield Brackets. Stamped in solid brass and polished to perfection. (4 pc. set)	1	1909-11	37.50 set
T-29-DB	Dash Brackets for Wood Dash. (5 pcs.) Solid brass. Highly polished. USA.	1	1909-11	22.50 set
T-30	Windshield Rubber Set. Open Car.	1	1915-22	7.95 set
T-31	Windshield Rubber Set. Open Car.	1	1923-25	7.95 set
T-31-A	Windshield Rubber Set. Open Car.	1	1926-27	9.95 set
T-32	Cowl Vent Door Gasket.	1	1926-27	3.50 ea.
T-33	Cowl Seal Rubber. Between windshield frame bottom & Open Car body.	1	1915-25	2.95 ea.
T-33-A	Cowl Seal Rubber. Between windshield frame bottom & Open Car body.	1	1926-27	2.95 ea.
T-34	Speedometer Cable Housing. Polished brass. 60" x 3/4" x 20 fine. Fits Stewart.	1	All	75.00 ea.
T-35	Speedometer Cable Housing. Polished brass. 60" x 7/8" x 18 fine. Fits Jones.	1	All	75.00 ea.

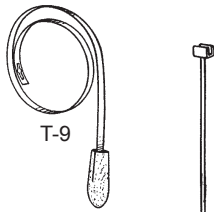

T-9



T-12-B/C



T-11



T-13-B/C



T-14-B



T-14-CS



T-14-MB/MC

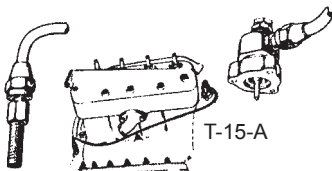

T-15-A



T-20

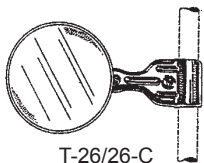

T-26/26-C



T-40

# Model T Parts

All prices listed in catalog subject to change. Call for current prices.



T-45



T-48

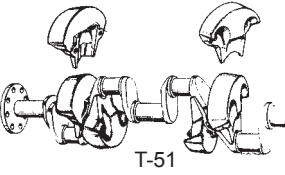

T-51

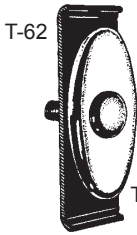

T-62

T-60



Part #	Description	Reqd.	Years	Price
<b>Model T Accessories</b>				
T-36	Speedometer Cable Housing. Polished brass. 60" x 7/8" x 18 coarse. Fits Ford. battery life. Not a replica.	1	All	75.00 ea.
T-40	Side Curtain Rods. Roadster & Roadster PU. (Set of 2) (Order 2 sets for Touring)	1	1926-27	9.95 set
T-45	Transmission Oil Strainer. Fits under transmission cover door. Magnet and 2 #3379-B gaskets included.	1	1911-27	37.95 ea.
T-47	Tire Cover. Script. Black vinyl. Fits 30 x 3 & 30 x 3 1/2 tire.	1	1909-24	37.95 ea.
T-47-T	Tire Cover. Script. Tan vinyl. Fits 30 x 3 & 30 x 3-1/2 tire.	1	1909-24	34.95 ea.
T-48	Tire Cover. Script. Black vinyl. Fits 21" tire. Wood or wire wheel.	1	1924-27	37.95 ea.
T-48-T	Tire Cover. Script. Tan vinyl. Fits 21" tire. Wood or wire wheel.	1	1924-27	34.95 ea.
T-51	Crankshaft Counterweights. (4 pc. set) Duplicate of Dunn Style. Ductile provides added strength.	1	1909-27	99.95 set
T-56	Bumper Face Bars. Stainless steel. Front or rear. (2 Bars)	1	1925-27	262.50 set
T-57	Front Bumper Mounting Bracket Set with Mounting Kit & Instructions.	1	1926-27	98.50 set
T-58	Bumper Clamp. Large outer with bolt. Painted black.	2	1925-27	12.95 ea.
T-60	Bumper Clamp. Large outer w/ bolt. Chromed.	2	1925-27	14.95 ea.
T-62	Bumper Clamp Backing Plate. Holds outer clamps to face bars. Steel painted black.	2	1925-27	5.25 ea.
T-64	Round Center Bumper Clamp w/ Backing Plate. With "Ford Made In U.S.A." as original.	1	1925-27	9.95 ea.

## Model T Trim Screws

First Grade Nuts, Bolts and Trim Screws for your Model 'T' interior. These are nickel plated and as close to the original as can be found.

TT-1	Roadster & Touring. (30 pcs.)	1	1917-22	4.00 set
TT-2	Coupe. (116 pcs.)	1	1919-22	13.95 set
TT-3	Center Door. (148 pcs.)	1	1917-22	17.95 set
TT-4	Roadster & Touring. (28 pcs.)	1	1923-25	3.00 set
TT-5	Coupe. (106 pcs.)	1	1923-25	14.95 set
TT-6	Fordor Sedan. (192 pcs.)	1	1923-25	22.95 set
TT-7	Roadster & Touring. (22 pcs.)	1	1926-27	2.95 set
TT-8	Coupe. (99 pcs.)	1	1926-27	13.95 set
TT-9	Tudor Sedan. (52 pcs.)	1	1926-27	7.95 set
TT-10	Fordor sedan. (200 pcs.)	1	1926-27	22.95 set
TT-11	Model T Cotter Pin Set. (97 pcs.)	1	1909-27	5.95 set

## Data Plates

P-1 thru P-6 are duplicates of the patent plate applied at the factory during production

P-1	Patent Plate w/Rivets. Brass.	1909- Mid '11	5.95 ea.
P-2	Patent Plate w/Rivets. Brass.	Late '11- Early '12	5.95 ea.

All prices listed in catalog subject to change. Call for current prices.

Part #	Description	Reqd. Years	Price
<b>Data Plates</b>			
P-3	Patent Plate w/Rivets. Brass. Large plate.	Late 1912	6.95 ea.
P-4	Patent Plate w/Rivets. Brass.	1917-18	5.95 ea.
P-5	Patent Plate.	1919-25	1.50 ea.
P-6	Patent Plate.	1926-27	1.50 ea.
P-7	K.W. Switch Plate w/ Rivets for Coil Box.	1911-14	11.50 ea.
P-9	Radiator Patent & Number Plate. Brass.	1909-16	26.95 ea.



P-4



P-5



P-6



P-7

## Model TT Truck Parts

TT-1005	Rear Axle Housing Cap Gasket. Used on the worm drive differential cap.	1918-27	2.25 ea.
TT-1008-S	Worm Drive Axle Gasket Set. Rear end gaskets for worm drive TT truck. (4 pc. set)	1918-27	16.95 set
TT-1017	Rear Axle Steel End Caps with Felts & Steel Washers (6 pc. set).	1 1918-27	39.95 set
TT-1019	Axle Shaft Outer Roller Bearing. Fits TT-1020.	2 1918-27	49.95 ea.
TT-1020	Axle Shaft Rear Bearing Sleeve. Fits right or left side.	2 1918-27	19.95 ea.
TT-1021	Axle Shaft Bearing Felt.	2 1918-27	1.95 ea.
TT-1026	Rear Axle Inner Grease Seals. Steel with Neoprene inner seal.	1 1918-27	49.95 pr.
TT-1028-B	Differential Gear Case. Right or left.	2 1923-27	22.50 ea.
TT-1037	Torque Tube Gasket. Fits the torque tube flange on the worm drive rear end.	1919-29	3.00 ea.
TT-1039	Drive Shaft Felt.	1 1918-27	1.95 ea.
TT-1046	Worm Gear Roller Bearing.	2 1918-27	64.95 ea.
TT-1057	Brake Lining. Woven type with rivets. (4 pc. set)	1 1918-27	79.95 set
TT-1062	Brake Expander Lever.	2 1918-27	9.50 ea.
TT-1064	Brake Expander Adjusting Collar.	2 1918-27	7.50 ea.

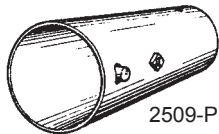

2509-P

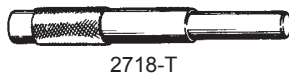

2718-T



3044-DR



3061-W



3061-W

## Model T Tools

2505-WP	Wheel Puller. Screw-on type. Our superior design will not strip the threads on your axle. Made in Ohio (Not useable on T steering)	1 1912-48	2.95 ea.
2509-P	Rear Axle Sleeve Puller. Passenger Car only.	1 1909-27	14.95 ea.
2718-T	Spindle Arm Bushing Driver. Also for front & rear spring perch bushings. Case hardened.	1 1909-27	7.95 ea.
3044-DR	Camshaft Rear Bushing Driver.	1 1909-27	7.95 ea.
3052-G	Valve Setting Gauge. This stainless gauge sets valve clearance by piston travel. Instructions incl.	1 1909-27	14.95 ea.
3052-R	Valve Guide Reamer. Reams worn guides to .3275. USA.	1 1909-27	56.95 ea.
3053	Valve Spring Compressor Tool. Quality tested for proper fit. Instructions included.	1 1909-27	29.95 ea.
3061-W	Exhaust Pack Nut Wrench. Ductile iron. A much needed tool to tighten or remove the exhaust pack nut. USA.	1 1909-27	28.95 ea.
3170	Timer Calibrating Gauge. Authentic tool for tiger timers.	1 1911-27	1.25 ea.
3314-D	Triple Gear Bushing Driver. Hardened steel.	1 1911-27	7.95 ea.

# Model T Parts

All prices listed in catalog subject to change. Call for current prices.

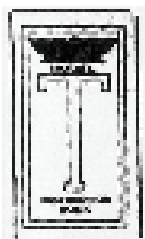
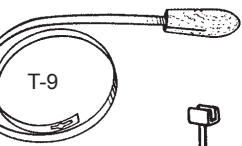
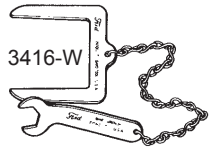

Part #	Description	Reqd.	Years	Price
3416-W	Transmission Band Adjusting Wrench & Holder. Chained together to prevent loss.	1	1909-27	18.95 ea.
T-9	Transmission Band Changer. Easy extra hand.	1	1909-27	9.95 ea.
T-11	Oil Check Rod. The only way to check your oil.	1	1909-27	4.95 ea.

## Model T Rubber

4530	T Rubber for Open & Closed Car & Truck Windshield Weatherstrip Groove. Concave head. 3/4" - 9/32" head.			0.75/ft.
4531	T Rubber for Open & Closed Car & Truck Windshield Weatherstrip Groove. Concave head. 1" - 9/32" head.			0.75/ft.
4581	Windshield Weatherstrip. 'H' style for 1/4 glass.			0.75/ft.
A-16345	Black Fender Welt. 1-1/2" wide. (3/16" bead) Bright, smooth finish bead. 25' roll.			7.50/roll

## Model T Extras

T-Hat	Blue Ford T Baseball Hat.			10.95 ea.
T-LUBE	T Lubrication Chart			7.50 ea.
T-TS	Model T Trouble-shooting Poster. An authoritative chart outlining the common derangements that interfere with proper action of engine & auxilliary systems.		1909-27	7.95 ea.
T-WP	Model T Parts Poster. This poster is a copy of an original Parts Department Wall Poster showing Passenger and TT Truck parts. 22" X 28"			4.95 ea.

## Model T Books

TB-1	<b>Model T Service &amp; Repair Manual 1909-27</b> The "Bible" for the Model T man. Original book by company for all Model T years. 320 pages, 577 illustration.			32.95 ea.
TB-2	<b>Model T Instruction Book 1909-15</b> This small booklet was supplied for the owner's use. 48 pages, 18 illustrations.			11.95 ea.
TB-3	<b>Ford Manual 1915-25</b> The first known attempt to guide the mechanic in repair by questions & answers. 64 pages, 26 illustrations.			12.95 ea.
TB-4	<b>Instruction Book 1926-27</b> Although dated as 1926-27, this book notes the changes of the Mid 1920's.			11.95 ea.
TB-5	<b>Parts List 1909-15</b> The first book for the Model T engine & chassis. 62 pages.			8.95 ea.

Part #	Description	Reqd. Years	Price
<b>Model T Books</b>			
TB-6	<b>Model T Parts and Accessories 1909-21</b> Complete parts list for the Model T Ford. 39 pages, 14 ill.		6.95 ea.
TB-6A	<b>Ford Price List of Parts.</b> Exact reprint of the 1923 Ford chassis parts list. Issued by Ford to identify the NEW style as well as the older style Model T.		5.95 ea.
TB-7	<b>Ford Price List of Parts 1922-27</b> List of engine & chassis parts including Ruckstell axle.		11.95 ea.
TB-8	<b>Price List-Chassis &amp; Body Parts 1923</b> 1 Ton TT Truck. 16 pages. TB-9 <b>Ford Price List of Body Parts 1923</b> 8.95 ea.		4.95 ea.
TB-10	Excellent illustrations of Model T body construction. 39 pages. <b>Ford Price List of Body Parts 1915-27</b>		11.95 ea.
TB-11	This is the most complete of Model T body parts' lists including the T pickup & truck.. 93 pages, 37 illustrations. <b>Windshield &amp; Glass Specifications 1915-27</b>		6.95 ea.
TB-13	Deminsions & diagrams for Truck and Passenger Car. 14 pages, 47 illustrations. <b>Ford to Frisco</b>		10.95 ea.
TB-15	Written by J. Smith Walsh, 41 pages, 1909-27. <b>Model T Memories 1909-27</b>		18.95 ea.
TB-16	Relates experiences one might have with the Model T. Data and information. 112 pages, 59 photos. <b>Floyd Clymer's Historical Motor Scrapbook</b>		21.95 ea.
TB-17	Photos & early ads about the Model 'T'. 229 Pages, 250 photos. <b>Model T Ford Owner's Supply Book 1909-27</b>		29.95 ea.
TB-18	Information on Model T accessories & replacement parts. 128 pages, 1,000 illustrations. <b>Model T Ford Restoration Handbook</b>		36.95 ea.
TB-19	The first book to get into Model T rebuilding. Written by Les Henry, a former Ford curator. 181 pages, 156 illustrations. <b>Model T Service Bulletins 1909-27</b>		34.95 ea.
TB-20	A reprint of original Model T service bulletins as issued by Ford. 520 pages, 900 illustrations. <b>Model T Speed Secrets: The Fast Ford Handbook 1909-27</b>		19.95 ea.
TB-21	Discover the fast Ford during the trial and errors of early day auto racing. 192 pages, 175 illustrations. <b>The Model T Ford Owner 1909-27</b>		32.95 ea.
TB-22	Articles covering the performance, operation and technical data. 528 pages, 800 illustrations. Hardbound. <b>Model T Ford in Speed &amp; Sport 1909-27</b>		23.00 ea.
TB-23	224 pages, 300 illustrations. <b>Model T Axles, Front &amp; Rear 1909-27</b>		12.00 ea.
TB-23-A	Great detail in this 30 page restoration manual for 'T' front or rear axles. We offer all 7 titles from <i>Model T Ford Club of America</i> . Our TB-23 thru TB-23-F. <b>Model T Engine Manual 1909-27</b>		12.00 ea.
TB-23-B	Repair & restoration of the 'T' motor is covered in this 24 page manual from the <i>MTFCA</i> . <b>Transmission Manual for Model T 1909-27</b>		12.00 ea.
	This <i>MTFCA</i> manual of 151 pages takes you step-by-step through the rebuilding of the transmission of the Model 'T'.		

All prices listed in catalog subject to change. Call for current prices.



TB-6



TB-7



TB-8

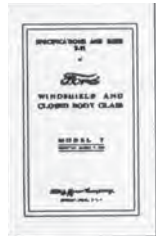

TB-11

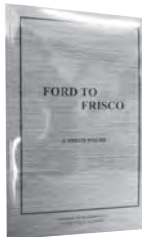

TB-13



TB-15



TB-16

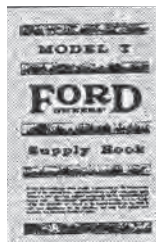

TB-17



TB-18

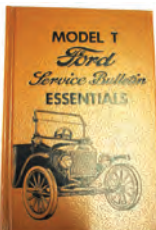

TB-19

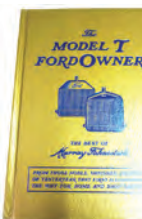

TB-21



TB-22

# Model T Parts

All prices listed in catalog subject to change. Call for current prices.



TB-23-C

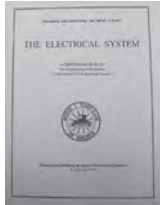

TB-23-E



TB-23-F



TB-24



TB-24-2

Part #	Description	Reqd. Years	Price
<b>Model T Ford Books</b>			
TB-23-C	<b>The Model T Carburetor 1909-27</b> This manual on the 'T' carburetor by the <i>MTFCA</i> is 48 pages, which covers all the carburetors types as found on our 'T's'. Great detail.		12.00 ea.
TB-23-D	<b>The Ruckstell Manual for Model T 1909-27</b> The complete Ruckstell R&R manual contains 35 pages of extensive details. Again the <i>MTFCA</i> brings to life an era of technical progress.		12.00 ea.
TB-23-E	<b>Electrical Manual, Model T 1919-27</b> <i>The Model T Ford Club of America</i> provides 48 pages of highly detailed information, including generator & starter rebuilding.		12.00 ea.
TB-23-F	<b>Speedometer Manual for Model T 1909-27</b> This 62 page manual covers models used through-out 'T' production. Well illustrated. <i>MTFCA</i> offers a look at this topic.		12.00 ea.
TB-24	<b>Model T Parts Identification Guide Vol. 1</b> Shows correct part for your Model T year. However not all part numbers listed. Covers early years properly. 61 pages.		17.95 ea.
TB-24-2	<b>Model T Parts Identification Guide Vol. 2</b> This second volume has over 260 illustrations to aid you in identifying genuine Model T parts.		17.95 ea.
TB-24-3	<b>Model T Parts Identification Guide Vol. 3</b> Over 300 illustrations and 52 pages to aid in identifying Model T parts.		22.95 ea.
TB-25	<b>Model T Parts &amp; Accessories 1909-26</b> Illustrated pocket size book shows what years will interchange.		6.95 ea.
TB-26	<b>Ford Sales Data Book 1926-27</b> This sales data book, used by salesmen, offers factory accessories for the improved Ford. 40 pages.		4.95 ea.
TB-27	<b>NEW Facts From Ford</b>		10.95 ea.





**See our many new & used parts  
on [www.gaslightauto.com](http://www.gaslightauto.com)  
and like us on facebook.**

As always, **MADE IN USA**

### Single Downdraft Manifold

Brand new, exact copy - cast in 356 - T6 heat treated aluminum, shot peened to relieve stress and allow easy cleaning. Has heat plate to allow for fast warm up. Takes Stromberg or Ford V8 3 bolt carburetor.

*\$265*



### Dual Downdraft Manifold

Brand new. Another exact copy, also cast in 356 - T6 heat treated aluminum, shot peened to relieve stress and allow easy clean up. *\$295*

### Model A Finned Side Cover

Still the best looking of them all! Fully finned and cast in 319 aluminum. Shot peened for ease of cleaning. Another exact copy. *\$120*



### Model B Finned Side Cover



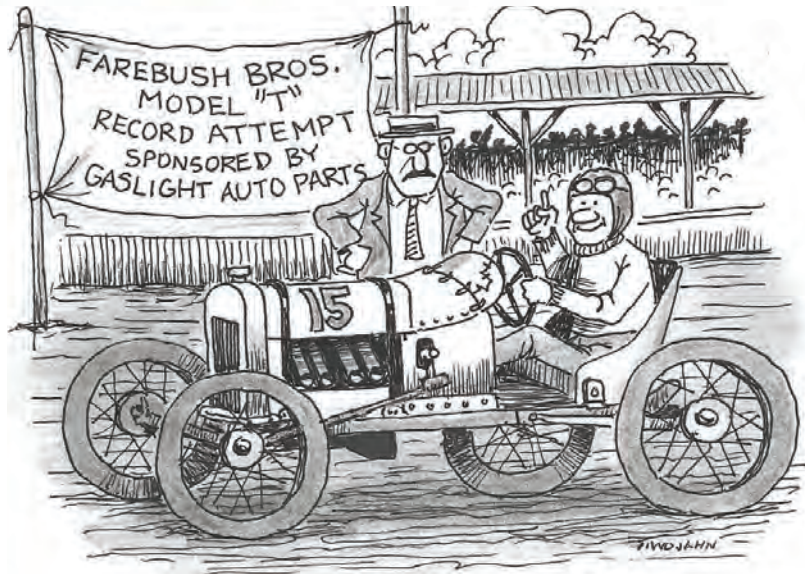

Copied from an original. Has three undrilled oil galley bosses to ease oil system modifications. Cast in 319 aluminum and shot peened. *\$120*



All prices listed in catalog subject to change. Call for current prices.

# Windshield Parts

All prices listed in catalog subject to change. Call for current prices.

Part #	Description	Reqd.	Years	Price
<b>Windshields (1913-36)</b>				
W-83	<b>NEW</b> Windshield Swing Arm Stud.			16.95 ea
W-123/5	Windshield Frame. Plain steel. Open Car. Glass setting channel & filler blocks not included.	1	1923-25	232.50 ea
W-124	Windshield Filler Block Set. Complete with glass clamps & filler blocks.	1	1913-27	39.95 set
W-126/7	Windshield Frame. Plain steel. Open Car and Pickup. (Glass channel not used).	1	1926-27	324.95 ea.
 W-127	W-127 Windshield Posts. Die stamped steel. Exact duplicate.	1	1926-27	187.50 pr.
W-128/9-S	Windshield Frame. Plain steel. Open Car & Pickup.	1	1928-29	269.95 ea.
W-130/1-D	Windshield Frame. Chrome plated. Deluxe Open Car.	1	1930-31	549.95 ea.
W-130/1-S	Windshield Frame. Plain steel. Open Car & Pickup. Standard.	1	1930-31	299.95 ea.
W-136	Rear Window Frame w/ Glass. Open Car. Polished stainless steel outer frame. Type B frame per judging sheet.	1	1928-31	159.95 ea.
 W-150	W-150 Rear Window Frame. Closed Car. This authentic steel stamping is from a Ford blueprint. Coupe, 2 & 4 Door Sedans & 155/165 B/D; 170 A&B; 60C; 130A; 135A.	1	1928-31	72.50 ea.
W-154	Steel Windshield Frame. Closed Car. Unfinished. (Use #320 sand paper before painting) Instructions & wiper template included. All body styles except 1928/60A. USA.	1	1928-29	625.00 ea.
 W-156	W-156 Steel Windshield Frame. Closed Car. (Use #320 sand paper before painting) Instructions & wiper template included. Coupe, Tudor, Closed Cab Truck only. USA.	1	1930-31	625.00 ea.
W-160	Windshield Frame for 68C Slant W/S & A-400. Triple chrome plated. Black powder coated on inside. Correct swing arm brackets. Instructions, gaskets, assembly tools included. USA.	1	1928-31	995.95 ea.
 W-170	W-170 Windshield Posts. Die stamped steel. Exact duplicate. (See this section for other parts to complete).	1	1928-29	239.95 pr.
W-171-S	Windshield Stanchion Mounting Screw Set.	1	1928-29	1.95 set
W-172	Windshield Posts. Die stamped stainless steel. Exact duplicate. Standard Open Car. 13-1/4" length.	1	1930-31	339.95 pr.
W-174	Windshield Posts. Die stamped stainless steel. Exact duplicate. Deluxe Open Cars. 12" long.	1	1930-31	339.95 pr.
W-175	Windshield Side Curtain Studs. Open. (12 pcs.)	1	1928-35	10.25 set
 W-176	W-176 Windshield Lower Stanchions for Open Car, Standard & Deluxe. Die stamped stainless steel. Exact duplicate.		1930-31	249.95 pr.
W-176-RS	Lower Stanchion Screw Set. Standard Roadster & Phaeton.	1	1930-31	1.95 set
W-176-S	Lower Stanchion Screw Set. Slotted, counter-sunk. Hex style. Fastens lower stanchion to cowl. Deluxe Open Car.	1	1931	4.95 set

Part #	Description	Reqd.	Years	Price
(4 pc. set) <b>Windshields (1913-36)</b>				
W-177	Spacers. Fits under stanchion posts on cowl.	1	1930-31	6.95 pr.
W-178-A	Windshield Frame. Aluminum. Closed Car. Well made duplicate. Includes hinge and brackets for swing arms. Safety glass installed. Coupe, Sport Coupe, Tudor, Fordor (except S/W). Closed Cab Truck.	1	1928-29	625.00 ea.
W-178-B	Windshield Frame. Aluminum. Closed Car. Well made duplicate. Includes hinge and brackets for swing arms and safety glass installed. Coupe, Tudor, Fordor (except S/W). Closed Cab Truck.	1	1930-31	625.00 ea.
W-180	Windshield Garnish Moldings. Coupe & Tudor Sedan.	1	1928-29	79.95 pr.
W-181	Windshield Garnish Moldings. Coupe, Tudor & Closed Cab Truck.	1	1930-31	61.00 pr.
W-182	Windshield Mounting Screw Set. For Closed Cars with wood header. Black oxide. (18 pcs.)	1	1928-29	2.95 set
W-184	Windshield Mounting Screw Set. For closed cars with wood header. Black oxide. (10 pcs.)	1	1930-31	1.95 set
W-186	Windshield Frame Screw Set. Holds frame together for Closed Car. Stainless steel.(8 pc. set)	1	1928-31	1.95 set
W-187	Windshield Frame Nut. Special nut swedged into brackets that W-190 swing arms are fastened to.	1	1926-34	2.95 pr.
W-188	Windshield Swing Arm Pivot Set. Includes sleeve, screw & washer. Closed Car & Truck. (6 pcs.)	1	1926-29	2.95 set
W-188-A	Windshield Swing Arm Pivot Set. (4 pcs.) Special screw & washer set. Clo. Car & Truck.	1	1930-31	1.00 set
W-189	Windshield Swing Arm Cup Washers. Plated with rubber inserts.	1	1926-32	2.50 pr.
W-190	Windshield Swing Arms. Chromed. 1926-31 Closed Vehicles & 1932-34 Closed Trucks.	1		11.95 pr.
W-190-SS	Windshield Swing Arms. Stainless steel. 1926-31 Closed Car & 1928-34 Closed Truck.	1		14.95 pr.
W-191	Windshield Swing Arms. Duplicate of original. V-8 Passenger Car.	1	1932	19.95 pr.
W-192	Windshield Swing Arm Bracket. Mounts on inside edge of sides of frame. Closed Vehicle.	2	1928-29	8.95 ea.
W-193	Windshield Swing Arm Knobs. Chrome plated. Fits 1926-32 Passenger Car & 1926-34 Pickup.	1		10.95 pr.
W-193-A	Swing Arm Knob Tension Washer Set. Fits 1926-32 Car & 1926-34 Closed Cab Truck.	1	1926-34	1.25 set
W-194	Windshield Swing Arm Bracket. Mounts on inside edge of sides of frame. Closed Vehicles except 1930-31 Slant W/S.	2	1930-31	8.95 ea.
W-195	Windshield Finger Pulls with Screws. Cromed. Fits Open Car. USA.	1	1928-31	14.95 pr.



W-188



W-189

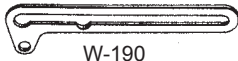

W-190



W-191



W-193



W-195

# Windshield Parts

All prices listed in catalog subject to change. Call for current prices.

Part #	Description	Reqd.	Years	Price
<b>Windshields (1913-36)</b>				
W-196	Windshield Wing Nuts. Chromed. 3/8"-24.. Open Car.	1	1923-31	4.95 pr.
W-196-V	Windshield Wing Nuts for V-8 Open Car. Chromed, die cast. Correct V-8 style. 3/8"-24.	1	1932-36	12.50 pr.
W-198	Top Stanchion Wing Screw. Chromed. 5/16-18NC. (Cut threaded length to 11/16")	2	1930-36	4.95 ea.
W-199	Top Stanchion Wing Screw. Chrome. 5/16 - 24 NF. Cut threaded length to 11/16".	2	1923-29	4.95 ea.
W-200	Windshield Swivels. For original type frames.		1923-34	9.95 pr.
W-201	Windshield Pivot Stud & Special Nut Open Car.	1	1923-36	4.95 pr.
W-202	Top Bow Hold Down Hooks. Used to hold top bows when top is down. They hook to grab handles A-19400.	1	1928-31	12.95 pr.
W-203	Top Mounting Bolt. Stainless steel. Holds top irons to bodybrackets. Open Car. (Used with W-204).	2	1928-31	1.25 ea.
W-204	Top Prop Nut. For top bow at body. Polished stainless steel face. Roadster. 1-1/2" dia. 7/16" Standard thread.	2	1925-31	10.00 ea.
W-205	Top Prop Nut Special Lock Washer. Open Car Only. (Used with W-204)	2	1926-34	1.50 ea.
W-206	<b>NEW</b> Windshield Filler Panel.			210.00 ea.

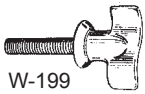

W-199



W-204



E-2



E-7



M-3



M-5



M-6



M-7



M-8



M-9

## Vintage Decals

All Decals - \$1.00 each

E-2	Model A Ford 1929	M-6	Hooray for Hoover
E-7	Fabulous Ford Forties	M-7	Win with Wilkie
M-3	Repeal the Volstead Act	M-8	Keep the Hun on the Run
M-5	Remember Pearl Harbor	M-9	Keep 'Em Flying. Buy War Bonds

*We appreciate Tom Wojahn's cartoon humor!*

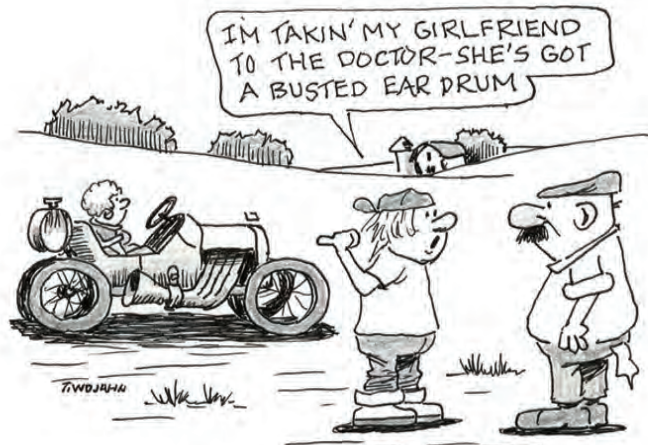

# 1928 to 1931



All prices listed in catalog subject to change. Call for current prices.

## Helpful Information

### Specifications

Rear Axle Ratio: 1928-31. 3.78-1 Std.  
 Cam Bearings: 1-9/16" Diameter — Clearance .003 Max.  
 Cam Lift: .302"  
 Camshaft Gear: 50 Tooth Phenolic Resin  
 Connecting Rod: 1-1/2" Dia. x 1.625" Clearance .001  
 Connecting Rod Length: 7.5  
 Cooling System: Capacity 3 Gals.  
 Crankshaft: Journals 1.625" Diameter  
 Crankshaft Gear: 25 Tooth Steel  
 Front & Center Main Bearing: 1.625" Dia. x 2" Long — Clearance .001  
 Rear Main Bearing: 1.625" Dia. x 3" Long, Clearance .001"  
 Crankshaft End Play: .002" to .004"  
 Tire Size: 1928-29 — 4.50 x 21, 1930-31 — 4.75 x 19  
 Tire Pressure: 35 P.S.I.  
 Tread: 56"  
 Engine: Bore — 3.875" Stroke — 4.250"  
 Horsepower: 40 @ 2200 RPM  
 Compression Ratio: 4.22 to 1.  
 Displacement: 200.5 C.I.  
 Firing Order: 1-2-4-3  
 Color: Ford Engine Green  
 Fuel Tank: Capacity 11 Gallons  
 28-9 10 Gal.  
 30-1 11 Gal.  
 Ignition: Plug Gap .035  
 Point Gap: .018" to .022 Gap  
 Oil Capacity: 5 Quarts  
 Valve Train: Spring Pressure 36#  
 Valve Tappet Clearance: .015"  
 Wheelbase: 103-1/2"  
 Head Torque: 50 ft.-lbs.

### Motor Numbers for Reference Only

1928:	1-810,122
1929:	810, 123-2, 742,695
1930:	2, 742, 696-4, 237, 500
1931:	4, 237, 501-4, 849, 340

# Model A Parts

All prices listed in catalog subject to change. Call for current prices.

Part #	Description	Reqd. Years	Price
	19" + 21"		
	30 X 3 + 30 X 3-1/2		
	16"		
	18"		

## Wheels & Tires

CC-19T	Lucas Tire 475/500 - 19" "Olympic" Tread. This is a cost effective 4 ply nylon tire. Import.	1930-31	110.00 ea.
CC-21T	Lucas Tire 440/450 - 21" "Olympic" Tread. This is a cost effective 4 ply nylon tire. Import.	1925-29	110.00 ea.
A-1012-B	Hub Bolt Nut. Acorn style. Plated.	23	1928-31 1.50 ea.
A-1012-BS	Hub Bolt Nut Set. Acorn style. Plated. (Set of 23)	23	1928-31 34.50 ea.
A-1012-C	Hub Bolt Nut. Acorn style. Chrome plated.	23	1928-31 1.70 ea.
A-1012-CS	Hub Bolt Nut Set. Acorn style. Chrome Plated. (Set of 23)	23	1928-31 39.00 ea.
A-1012-W	Lug Nut Washers. Stainless steel. (5 pc. set) (Use when tapered lug nut seat is badly worn.)		1928-53 2.50 set
A-1015-BR	21" Wheel. Made as original. Supplied in primer.		1928-29 460.00 ea.
A-1015-D	19" Wheel. Made as original. Supplied in primer.		1930-31 460.00 ea.
A-1023-BR	Spoke Brush. Great for cleaning 'A' rims.		All years 6.00 ea.
A-1024	Rubber Rim Liner. Fits around rim to protect inner tube from damage. Fits 19" & 21" wheels.		1926-31 2.50 ea.
A-1105	Front Hub. New. USA. High quality machined ductile steel. Hub is ready to have studs & drum installed. Passenger & Pickup.	2	1928-31 199.95 ea.
A-1107	Front Hub Bolt. 62 dia., 1/2-20. 1.44 OA lgth.	10	1928-35 .85 ea.
A-1107-L	<b>NEW</b> Front Hub Bolt. 1/16" longer for use with new brake drums.		1.75 ea.
A-1115	Rear Hub. New. USA. High quality machined ductile steel. Hub is ready to have studs & drum installed. Passenger & Pickup.	2	1928-31 229.95 ea.
A-1118	Rear Hub Bolt. .62 dia., 1/2-20 1.09 OA length.	10	1928-31 .95 ea.
A-1118-L	<b>NEW</b> Rear Hub Bolt. 1/16" longer for use with new brake drums.		1.75 ea.
A-1119	Hub Bolt Swedging Tool. Used to swedge shoulder of stud to the brake drum. (20 ton arbor press must be used with it).	1	1926-48 6.95 ea.
A-1125	Front Brake Drum. Cast iron. Ready for installing on the hub. USA. Pass. & Pickup.	2	1928-31 119.95 ea.
A-1126	Rear Brake Drum. (as above) Pass. & Pickup.	2	1928-31 119.95 ea.
A-1127	Brake Drum Reinforcing Band. Eliminates brake drum distortion, noise & clatter. Lengthens the life of the lining & keeps brakes in adjustment longer. Only use w/original drums.	1	1928-31 34.95 ea.
A-1129	Trim Ring for Hub Cap. Chrome plated. This is an accessory of the time.		1928-29 6.50 ea.



A-1012-B



A-1105



A-1115



A-1119



A-1125



A-1126

Part #	Description	Reqd.	Years	Price
<b>Wheels &amp; Tires</b>				
A-1130-BR	Hub Cap. .Stainless steel.		1928-29	9.95 ea.
A-1130-SL	Hub Cap. Stainless steel w/ steel inner liner.		1930-31	10.95 ea.
A-1139	Hub Dust Cap. Drive-in style.	2	1928-48	1.95 ea.
A-1139-B	Hub Dust Cap. Screw-in style.	2	1931-35	3.95 ea.
A-1175	Rear Wheel Grease Seal. Fits in hub.	2	1928-36	5.95 ea.
A-1175-A	Rear Wheel Grease Seal. Lg Truck. 3.78" OD	2	1928-29	17.95 ea.
A-1175-B	Rear Wheel Grease Seal. Lg Truck. 4.013" OD	2	1930-34	7.95 ea.
A-1180	Snap Ring for A-1225 & A-1175 in the Hub. (Also used with A-7040 at rear of A-7025)	2	1928-36	1.95 ea.
A-1183	Rear Wheel Hub Gasket on Axle. Behind A-1185.	2	1928-48	.65 ea.
A-1185	Rear Wheel Hub Washer. Fits between A-1183 & A-4242.	2	1928-48	.25 ea.
A-1190	Front Hub Inner Seal. Located at base of spindle to keep grease from brake material.	2	1928-34	1.95 ea.
A-1195	Front Spindle Washer. Acts as grease retainer.	2	1928-53	1.25 ea.
A-1201	Front Wheel Inner Bearing. Fits A-1202.	2	1928-48	19.95 ea.
A-1201-A	Front Wheel Inner Bearing. Large Truck.	2	1928-29	29.95 ea.
A-1201-B	Front Wheel Inner Bearing. Large Truck.	2	1930-59	14.95 ea.
A-1202	Front Wheel Inner Bearing Cup. Fits A-1201.	2	1928-48	12.95 ea.
A-1202-A	Front Wheel Inner Bearing Cup. Large Truck.	2	1928-29	12.95 ea.
A-1202-B	Front Wheel Inner Bearing Cup. Large Truck.	2	1930-37	12.95 ea.
A-1216	Front Wheel Outer Bearing. Fits A-1217.	2	1928-48	29.95 ea.
A-1216-A	Front Wheel Outer Bearing. Truck.	2	1928-29	14.95 ea.
A-1216-B	Front Wheel Outer Bearing. Truck.	2	1930-37	16.95 ea.
A-1217	Front Wheel Outer Bearing Cup. Fits A-1216.	2	1928-48	11.95 ea.
A-1217-A	Front Wheel Outer Bearing Cup. Truck.	2	1928-29	11.95 ea.
A-1217-B	Front Wheel Outer Bearing Cup. Truck.	2	1930-37	12.95 ea.
A-1218	Front Spindle Nut & Cotter Pin.	2	1928-35	1.95 ea.
A-1220	Wheel Bearing Grease. Premium grade high quality Hi-temp red grease from Timken is formulated to protect bearings from rust & corrosion & extended bearing life.	1	1909-48	6.95 ea.
A-1225	Rear Wheel Bearing. Fits inside hub.	2	1928-36	36.95 ea.
A-1225-B	Rear Wheel Bearing. Fits in hub. Truck.	2	1930-34	49.95 ea.
A-1379-AR	Rear Spare Wheel Bracket. Fits Roadster, Cabriolet, Coupe & Sport Coupe.	1	1928-29	56.95 ea.
A-1379-B	Rear Spare Wheel Bracket. Fits Roadster, Cabriolet, Coupe & Sport Coupe.	1	1930-31	56.95 ea.
A-1380-B	Rear Spare Wheel Bracket. Fits Tudor, Standard Fordor, Phaeton, Town Sedan, Taxi Cab, Town Car.	1	1928-31	56.95 ea.
A-1381	Rear Spare Bracket Support. Cast bracket fits curved inner panel (PA-1). Top bolt of carrier goes thru hole in end. Coupe, Roadster & Cabriolet.	1	1930-31	7.95 ea.
A-1381-B	Rear Spare Bracket Support. Steel brace supports inside of outer panel (PH) below deck lid. Coupe, Roadster & Cabriolet.	1	1930-31	37.95 ea.
A-1390	Rear Spare Bracket Block-off Screw Set. For use with side mount spare. (3 pcs.)	1	1928-31	5.95 set

All prices listed in catalog subject to change. Call for current prices.



# Model A Parts

All prices listed in catalog subject to change. Call for current prices.

Part #	Description	Reqd.	Years	Price
--------	-------------	-------	-------	-------

## Wheels & Tires

A-1395-AB	Spare Tire Cover for 21" Tire. Black vinyl with script screened in Ford blue.	1	1928-29	62.00 ea.
A-1395-AT	Spare Tire Cover for 21" Tire. Tan vinyl with script screened in Ford blue.	1	1928-29	62.00 ea.
A-1395-BB	Spare Tire Cover for 19" Tire. Black vinyl with script screened in Ford blue.	1	1930-31	62.00 ea.
A-1395-BT	Spare Tire Cover for 19" Tire. Tan vinyl with script screened in Ford blue.	1	1930-31	62.00 ea.
A-1400	Sidemount Bracket to Frame Bolt Set. (9 pcs.)	1	1928-34	4.50 set
A-1405-AR	Sidemount Bracket with Plate. Fits either side.	1	1928-29	49.95 ea.
A-1405-L	Sidemount Bracket with Plate. For spare tire mounted in left (Driver side) front fender.	1	1930-31	74.95 ea.
A-1405-R	Sidemount Bracket with Plate. For spare tire mounted in right (Pass. side) front fender	1	1930-31	74.95 ea.
A-1410	Sidemount Tire Arm Grommet. Exact duplicate.	1	1928-31	1.00 ea.
A-1448	Sidemount Plate Square Neck Stud. (Also 2 Top Studs on A-1379-AR & B)		1928-31	1.50 ea.



A-1395

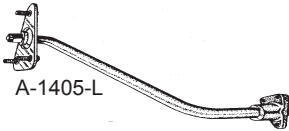

A-1405-L



A-1410



19" + 21"



30 X 3 + 30 X 3-1/2

## Inner Tubes with long rubber stems

CC-1	Inner Tube, 30 x 3-1/2. Use in 30 x 3 & 31 x 4 Tires.		1909-25	25.00 ea.
CC-2	Inner Tube, 4:50/5:50 x 21".		1925-29	25.00 ea.
CC-3	Inner Tube, 4:75/5:50 x 19". (Also used in 5:00 x 20").		1930-31	25.00 ea.
CC-4	Inner Tube, 5:25/5:50/6:50 x 17" or 18".			25.00 ea.
CC-5	Inner Tube, 5:50/6:00 x 16".			25.00 ea.
CC-19T	<b>NEW</b> Lucas Tire 475/500 - 19" "Olympic" Tread.			115.00 ea.
CC-21T	Lucas Tire 440/450 - 21" "Olympic" Tread. This is a cost effective 4 ply nylon tire. Import.		1925-29	115.00 ea.
CC-303T	Wards Riverside 30 x 3 Tire. A very popular replacement tire of the period. 4 ply nylon.		1908-18	151.00 ea.
CC-3035T	Wards Riverside 30 x 3.5 Tire. A very popular replacement tire of the period. 4 ply nylon.		1909-25	164.00 ea.

## Service Brake

A-2000	Adapter Ring Set for Juice Brakes. Converts '28-36 spindles to hydraulic brake backing plates from '39-48 Fords. Large ring centers plate on spindle. Small ring fits behind A-1201 brg.	1	1928-36	16.95 set
A-2011	Front Backing Plate Bolt Set. (8 bolts & 8 castle nuts per set). 1 set per car.	1	1928-34	10.95 set
A-2011-C	Front Brake Roller Track Set. Produced & heat treated to factory specifications. Complete for both front wheels.	1	1928-34	24.95 set
A-2011-D	Rear Brake Roller Track Set. Produced & heat treated to factory specs. Complete for both rear wheels. (Includes A-2230 & A-2231)	1	1928-34	109.95 set
A-2013	Brake Track Rivets (4 pc. set). These special rivets are used for front or rear brake tracks. Must be installed red hot. (Protect short end when peening rivet.) Fits 1928-34 except AA/BB.		1928-34	3.50 set



Part #	Description	Reqd.	Years	Price
<b>Service Brake</b>				
A-2018	Service Brake Rivet Set. (20 pcs.)		1928-31	2.95 set
A-2018-T	Brake Riveting Tool. This set comes complete w/a punch to remove the old rivets, a tool to drill & countersink the lining & a tool to install new rivets. (T, A & Early V-8)	1	All years	22.50 set
A-2021-SW	Brake Lining. Original woven wire type with rivets. (8 pc. set)	1	1928-31	99.95 set
A-2023	Brake Shoe Rollers. Hardened steel. Made in USA. (Set of 16)	1	1928-34	18.95 set
A-2027	Brake Adjusting Shaft Pins. (Set of 8) Fits end of shoe to hold A-2042.	1	1928-34	3.95 set
A-2035-S	Long Brake Shoe Springs. (Set of 4)	1	1928-34	4.25 set
A-2036-S	Short Brake Shoe Springs. (Set of 8)	1	1928-31	4.95 set
A-2041	Brake Adjusting Wedge Bolt. Hardened steel. Passenger & Commercial.	4	1928-36	8.95 ea.
A-2041-C	Brake Adjusting Wedge Cap. Acts as grease retainer & dust shield.	1	1928-36	2.25 pr.
A-2042	Brake Adj. Shaft. 2 per wheel. Front or rear.	8	1928-34	6.50 ea.
A-2045	Brake Shoe Roller Pins. (Set of 8) USA. These hold the A-2023 in position.	1	1928-34	2.75 set
A-2050	Front Brake Operating Wedge. To activate braking action on front wheels only.	2	1928-34	16.95 ea.
A-2051	Stud & Washer for Brake Wedge. USA Used to mount A-2050 wedge on backing plate. Includes special washer. (2 sets per vehicle)	2	1928-34	6.95 ea.
A-2051-B	Front Wedge Mounting Nut, Washer, Pin Set. (6 pc. set)	1	1928-34	3.95 set
A-2051-FL	Brake Energizer Kit. Full floating action. U.S.A. This kit is a Great alternative to hydraulic brakes.	1	1928-35	269.95 kit
A-2060-B	Front Brake Grease Baffle. Bolts onto the backing plate. Keeps grease off the brake lining.		1928-31	23.95 ea.
A-2075	Front Brake Operating Pin.	2	1928-31	2.25 ea.
A-2076	Front Brake Operating Pin Shims. Small stamped steel disc to shim worn A-2075 & A-2050. Improves braking action.		1928-34	.95 pr.
A-2076-B	Front Brake Operating Shaft. RH. Shaft raises A-2076 operating pin inside the king pin. This USA forging from Ford blueprint offers smooth brake action. Passenger side.	1	1928-31	22.50 ea.
A-2077-B	Front Brake Operating Shaft. Left hand. Driver's side. See # A-2076-B	1	1928-31	22.50 ea.
A-2082	Front Brake Shaft Bushings. (Set of 4)	1	1928-36	1.95 set
A-2084	Front Brake Lever. Forged steel. Lever is pinned to the brake operating shaft A-2076-B & A-2077-B. Service brake rods rest in yoke.	2	1928-31	21.00 ea.
A-2085	Front Brake Lever Pins. (Install pin and heat red hot and peen ends).	1	1928-34	1.00 pr.
A-2087-S	Dust Rings. Install on brake cam to keep dirt out of the bushings.	1	1928-31	1.25 set

All prices listed in catalog subject to change. Call for current prices.

# Model A Parts

All prices listed in catalog subject to change. Call for current prices.

Part #	Description	Reqd.	Years	Price
<b>Service Brake Controls</b>				
A-2211-B	Backing Plate and Hardware Kit. Kit includes: (1) A-2230, (1) A-2231, (2) A-2042, (1) A-2041 Powder Coated.	1		169.95 kit
A-2227	Rear Brake Bushings. (Set of 8) Fits both emergency & service brakes.	1	1928-34	15.95 set
A-2228-T	Bushing Driver Tool. To remove brake shaft & spring shackle bushings. Case hardened steel.	1	1909-34	12.95 ea.
A-2230	Rear Brake Cam. Hardened steel. USA. Fits inside A-2231 & activates rear brakes.	2	1928-34	6.95 ea.
A-2231	Rear Brake Camshaft. Holds A-2230 & activates the rear braking system. USA.	2	1928-34	15.95 ea.
A-2235-C	Rear Service Brake Lever. Right rear.	1	1928-31	14.95 ea.
A-2236-C	Rear Service Brake Lever. Left rear. Lever is pinned to A-2231; rear brake rod eye fits in end.	1	1928-31	14.95 ea.
A-2238	Rear Brake Camshaft Lever Pins. Holds A-2231 in place. (Install red hot and peen in place).	1	1928-34	.75 pr.
A-2240-B	Rear Brake Grease Baffle. Used to keep grease off the brake lining. Mounts on backing plate to axle housing bolts. Order 1 for each rear wheel.		1928-31	7.50 ea.
A-2248-50	Rear Backing Plate Bolt Set for 1 Wheel. 2 sets per vehicle (12 pcs.).		1928-31	15.95 set
A-2455-ACC	Brake Pedal Return Spring & Bracket. A frequently asked for item that Henry did not install. Also helps return that sticky stop light switch. Instructions included.		All years	5.95 set
A-2457	Brake Pedal Clevis Pin. Used on brake pedal. Stop light link A-13705 hooks to this.	1	1928-29	1.50 ea.
A-2461	Brake Rod Clevis. Two prong style. Forged steel.	2	1928-34	2.75 ea.
A-2462	Clevis Pin Set for Brake Rods & Clevis. Plated. (14 pc. set)	1	1928-36	2.75 set
A-2465-B	Brake Pedal Rod to Cross Shaft. 16" long.	1	1929-34	19.95 ea.
A-2466	Brake Rod Adjusting Clevis. Fits A-2499.	4	1928-35	5.50 ea.
A-2469	Brake Clevis Check Nuts. Tighten these stainless steel check nuts against clevis to maintain adjustment. (7 pc. set)	1	1928-34	1.95 set
A-2477	Brake Cross Shaft Bushings. Exact duplicate with woven lining.	1	1928-31	17.95 pr.
A-2477-SB	Split Bronze Cross-shaft Bushings. Installs without removing brake rod arm from cross shaft. 100% true round.	1	1928-31	17.50 pr.
A-2478/9	Cross Shaft to Frame Bracket Set. Powder coated black.	1	1929-31	10.95 set
A-2478/9-B	Cross Shaft Bracket Nut & Bolt Set. (8 pcs.) For cross shaft to frame brackets.	1	1929-31	3.95 set
A-2485-A	Cross Shaft Brackets w/Modern Grease Fitting. Set includes brackets & split bronze bushing drilled with a modern grease fitting & mounting hardware.	1	1928-31	44.95 set
A-2499	Service Brake Rod. (also '28-29 AA Trucks)	4	1928-31	13.95 ea.

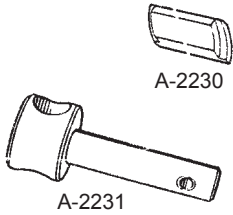

Part #	Description	Reqd.	Years	Price
--------	-------------	-------	-------	-------

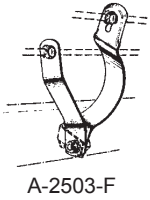

A-2503-F

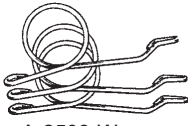

A-2503-W

A-2503-F	Brake Rod Anti-Rattler Spring Steel Bracket Set w/ Mounting Hardware. Flat style. (6 pc. set.)	1	1928-31	11.95 set
A-2503-W	Brake Rod Anti-Rattlers. Wire type w/ mounting hardware. (6 pcs.)	1		9.95 set
A-2504-MB	Brake Rod Anti-Rattler Bolt Set. (12 pc. set)	1	1928-31	1.95 set

## Emergency Brake



A-2609



A-2620-A



A-2624



A-2628



A-2632

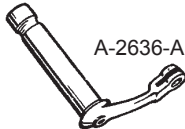

A-2636-A

A-2600	Emergency Brake Carrier Assembly. R/H. Includes (4) A-2227 bushings installed, not reamed. Passenger Side.	1	1928-31	89.50 ea.
A-2601	Emergency Brake Carrier Assembly. L/H. (As above) Driver side.	1	1928-31	89.50 ea.
A-2609	Emergency Brake Shoe.(less lining) Factory blueprinted. USA.	2	1928-31	29.95 ea.
A-2620-A	Emergency Brake Lining Set. Original style woven stock w/ rivets.	1	1928-31	29.95 set
A-2624	Emergency Brake Band Retainer Springs. (Set of 4).	1	1928-31	1.95 set
A-2628	Emergency Brake Band Toggle Link. Plated. (Offsets on links must match to create a straight line).	4	1928-31	5.95 ea.
A-2632	Emergency Brake Shoe Connecting Link.	2	1928-31	16.95 ea.
A-2633	Emergency Brake Toggle Pin Set. This 8 piece pin set is for the toggle links A-2628 & the A-2636-A toggle levers of the emergency brake system.	1	1928-31	2.95 set
A-2636-A	Emergency Brake Toggle Lever. Fits in rear backing plate. (Uses 2 A-2227 bushings each side)	2	1928-31	24.95 ea.
A-2641	Emergency Brake Levers Bolts, Keys & Lock Washers. (6 pcs.)	1	1928-31	1.50 set
A-2642	Emergency Brake Lever. Right side.	1	1928-31	14.95 ea.
A-2643	Emergency Brake Lever. Left side.	1	1928-31	14.95 ea.
A-2644	Emergency Brake Lever Woodruff Keys.	1	1928-31	.50 pr.
A-2646/7	Emergency Brake Lever Springs. (set of 2: 1 ea., right & left)	1	1928-31	1.95 set

## Hand Brake Lever



A-2780-AR



A-2780-C



A-2780-AR

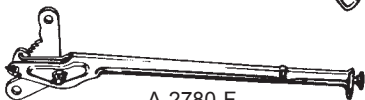











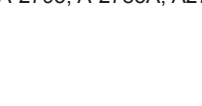
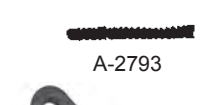



A-2780-F

A-2780-AR	Hand Brake Lever Assembly. Squeeze style. Complete w/ ratchet. Center mount. Used thru Dec. 1928	1	1928-29	79.50 ea.
A-2780-C	Hand Brake Lever Assembly. Button top. This push-button style, front mount assembly was introduced in Jan. 1929 and used until right side mounted A-2780-F was introduced in late 1929.	1	late 1929	79.95 ea.
A-2780-F	Hand Brake Lever Assembly. Button top. Complete w/ ratchet. Mounts on right side of transmission.	1	1929-34	79.95 ea.
A-2782	Emergency Brake Handle Pivot Bolt. Mounts hand brake to ratchet.	1	1929-31	1.95 ea.

# Model A Parts

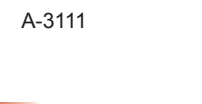
All prices listed in catalog subject to change. Call for current prices.

Part #	Description	Reqd.	Years	Price
<b>Hand Brake Lever</b>				
 A-2785-A	Emergency Brake Pawl Rod. 15". Releases brakes. Used with grip style handle.	1	1928-29	14.95 ea.
 A-2785-B	Emergency Brake Pawl Rod. 17-5/8". Releases brakes. Used with push button style.	1	1929-34	4.95 ea.
 A-2786-DR	Emergency Brake Lever Pawl. USA. This improved design pawl matches our A-2795-D emergency brake ratchet with finer teeth for closer braking action.	1	1929-31	7.95 ea.
 A-2791	Brake Handle Release Button. Chromed. The button your thumb depresses to release the emergency brakes. USA.	1	1929-34	3.50 ea.
 A-2792-AR	Hand Brake Lever Top Sleeve. Used on push button handbrakes. Mounted in front of gear shift. Late 1928 thru July 1929.	1		14.95 ea.
 A-2793	Emergency Brake Handle Spring.	1	1928-29	.35 ea.
 A-2795-D	Emergency Brake Ratchet. The fine teeth provide accurate brake action. USA.	1	1929-31	24.95 ea.
 A-2839	Emergency Cross Shaft Brass Bushings. Fits on end of emergency brake cross shaft. Passenger & Commercial.	1	1928-29	24.95 pr.
 A-2840	Emergency Brake Cross Shaft Grease Felts & Spring Set. Located at each end of shaft inside A-2839 brass bushings.	1	1928-29	3.95 set
 A-2845	Emergency Brake Cross Shaft Bracket. Fits inside frame to hold the shaft to the frame. A-2839 fits inside this. Pass. & Comm.	2	1928-29	10.95 ea.
 A-2846	Emergency Cross Shaft Bracket Bolts. Mounts A-2845 brackets to inside of frame. (18 pc. set)	1	1928-30	2.95 set
 A-2853-A	Emergency Brake Handle to Cross Shaft Rod. With eye on one end. 20-3/4" long. 1928 thru Mid 1929.	1	1928-29	18.95 ea.
 A-2853-D	Emergency Brake Handle to Cross Shaft Rod. With yoke on each end. 18-3/4" long.	1	mid '29-31	46.95 ea.
 A-2864	Emergency Brake Rod. Fits cross shaft to toggle lever on backing plate.	2	1928-31	13.95 ea.
 A-2865-A	Adjustable End Clevis. Fits cross shaft to A-2864 emergency brake rod.	2	1928-31	2.50 ea.
<b>Front Axle</b>				
 A-3030	Front Spring Perch & Special Nut. Passenger & Commercial.	2	1928-31	58.95 ea.
A-3034	Front Spring Bushing.	4	1928-31	.50 ea.
A-3036	Front Spring Perch Tapered Castle Nut. Holds perch snugly to axle.	2	1928-48	2.25 ea.
A-3110	King Pin Bushing. Used in spindle bolt rebuilding when the bolts are reuseable. (Ream to .814. Line grease holes up w/ spindle holes).	4	1928-41	1.95 ea.
A-3111	Spindle Bolt Set. Pins, bearings, bushings, etc. (18 pcs.) All Passenger, Commercial and AA thru Mid 1929.	1	1928-31	94.50 set
A-3111RK	Spindle Bolt Rebuild Kit. Contains everything needed to rebuild your worn front end except the king pins. (22 pcs).	1	1928-41	19.95 kit

All prices listed in catalog subject to change. Call for current prices.

Part #	Description	Reqd.	Years	Price
<b>Front Axle</b>				
A-3113	Spindle Bolt Thin Shim .010. Fits between bearing A-3123 & top of axle. Compensates for wear on axle.	1	1928-41	.50 ea.
A-3120	Front Spindle Felt Retainer. The cup washer that holds large felt under axle. (Install cup side down. Use A-3125 felt).	2	1928-31	.75 ea.
A-3121	Spindle Bolt Grease Retainer Felts. Small size. A-2075 pin passes through these.	1	1928-37	1.00 pr.
A-3122/4	Spindle Bolt Locking Bolt & Nut Set. (6 pc. set) Holds spindle bolts in the axle.	1	1928-48	7.50 set
A-3123	Bearing Used with Spindle Bolts. Takes 2. (Also used as A-3571 bearing with A-3575-B 7 tooth sector)	2	1928-48	3.95 ea.
A-3124	Spindle Bolt Locking Pin Nut.	2	1928-48	2.95 ea.
A-3125	Spindle Bolt Lower Grease Felt Retainers. Large size fits bottom of axle.	1	1928-48	1.00 pr.
A-3281	Tie Rod. Solid steel. USA. Connects the right & left spindle arms. (Often a bent or worn rod leads to steering problems)	1	1928-34	16.95 ea.
A-3285	Tie Rod End. Right hand. Complete w/internals.	1	1928-34	23.95 ea.
A-3285/6-MB	Tie Rod End Clamp Bolt Set.	1	1928-34	4.50 set
A-3286	Tie Rod End. Left hand. Complete w/ internals.	1	1928-34	23.95 ea.
A-3305	Steering Drag Link Tube. Less internal parts. (Requires (1) set A-3305-S)	1	1928-31	79.95 ea.
A-3305-S	Tie Rod and Drag Link Repair Kit. All the internal for both ends of tie rod or drag link.	2	1928-34	11.25 kit
A-3305-T	<b>NEW</b> Tie Rod and Drag Link Plug Tool.			7.95 ea.
A-3311	Drag Link & Tie Rod Ball Stud. Replacement ball for Pitman Arm & spindle arms. This is straight shank weld-in style.	4	1928-34	8.95 ea.
A-3332	Drag Link & Tie Rod End Seals. Rubber seals keep dirt out & grease in. (set of 4)	1	1928-34	2.95 set
A-3333	Drag Link & Tie Rod End Metal Caps. Holds A-3332 in place. (set of 4)	1	1928-34	2.95 set
A-3405-W	Radius Rod Ball Spacer/Steel Washer.	1	1928-31	1.00 ea.
A-3425	Radius Rod Socket Felt.	1	1928-31	.95 ea.
A-3430-N	Original Radius Rod Nut.	2	1928-34	1.50 ea.
A-3430-RS	Radius Rod Socket Kit w/ Rubber Bushing. Compensate for worn radius rod ball.	1	1928-31	15.95 kit
A-3430-S	Radius Rod Socket Set. Original style. Stamped steel caps w/ springs, sleeves, nuts, pins.	1	1928-31	28.95 set
A-3441	Felt Retaining Radius Rod Cap Pin. 5-11/16".	1	1928-31	.95 ea.
A-3442	Radius Rod Socket Bolt.	2	1928-31	6.95 ea.
A-3446	Radius Rod Ball Rubber Bushing. Reduces wear on the ball end.	1	1928-40	1.95 ea.











## Steering



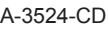







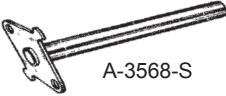















A-3506	Steering Column to Frame Mounting Bolt Set. (Set of 6 pcs.)	1	1928-31	6.50 set
--------	---	---	---------	----------



# Model A Parts

All prices listed in catalog subject to change. Call for current prices.

Part #	Description	Reqd.	Years	Price
<b>Steering</b>				
 A-3517	A-3517 Upper Shaft Housing Bearing. Chromed. This fits all years. 1928-29 style w/ 2 mounting screws. 1930-31 style w/ locating pin to center in the "V" notch in the original column.	1	1928-31	10.95 ea.
 A-3519	A-3519 Steering Column Lower Support Clamp. Holds column in bracket inside of vehicle. All Models.	1	1928-31	14.95 ea.
	A-3519-S Steering Column Clamp Screw Set. Holds lower clamp A-3519 to A-3520 steering column support.	1	1928-31	1.95 set
 A-3520	A-3520 Steering Column Support. The improved support by Ford. Earlier style developed leaks where it was riveted to tank. This mounts behind dash rail. Ductile iron. USA.	1	1930-31	42.95 ea.
	A-3521 Steering Column Rubber.	1	1928-31	.95 ea.
	A-3524-A Steering Worm. Fits 7 tooth sector. USA.	1	1928-29	42.50 ea.
	A-3524-CD Steering Worm. Fits 2 tooth sector.	1	1929-31	64.95 ea.
 A-3525	A-3525 Steering Shaft. This splined shaft is 44" long and will work on 80% of all Gemmer 2 tooth columns. (If 43" is what you need, cut the splined end and press on the worm).	1	1929-31	76.95 ea.
 A-3524-CD	A-3526 Steering Shaft w/ Worm Pressed On. The 44" long steering shaft w/ top quality 2 tooth worm pressed on. Fits 80% of Gemmer 2 tooth columns. Passenger & Commercial.	1	1929-31	156.95 ea.
 A-3527	A-3527-BR Retainer Steering Gear Housing Oil Seal. 7 tooth only.	1	1928-30	5.95 ea.
	A-3527-T Steering Shaft Oil Tube & Retainer. This will prevent oil leaking into the light switch housing. 7 tooth steering box only.	1	1928-29	12.95 ea.
	A-3529 Horn/Light Rod Anti-rattle Bushing. Bushing slides up the wiring tube to the top, under light switch handle.	1	1929-32	1.35 ea.
 A-3527-T	A-3538 Steering Box Oil Filler Plug. Square plug that fits on the top of the steering box. Used Oct. 1929 thru 1948.	1		.60 ea.
	A-3540 Anti-rattle Felt-Spark/Gas Rods. Felts slide up rods to 14" from top. Insert rods in upper bushing first. Keeps rods rattle free.	1	1928-31	.75 pr.
	A-3540-AR Spark & Throttle Rods in Steering Column. Chrome. 30" long. (measure under handle to end)	1	1928-29	32.95 pr.
 A-3540-C	A-3540-C Spark & Throttle Rods in Steering Column. Chrome. 31" long.	1	1930-31	36.95 pr.
 A-3541	A-3541 Control Arm Set. Fits bottom of spark & throttle rods on steering column. Complete w/pins.	1	1928-31	18.95 set
	A-3545 Control Rod Springs.	1	1928-31	.75 pr.
 A-3548	A-3548 2 Tooth Housing w/ Needle Bearings and Modern Seal.	1	1929-31	105.00 ea.
	A-3552 Steering Worm Bearing Cup, Lower. Fits A-3571-C bearing.	1	1929-31	15.95 ea.
 A-3553-D	A-3553-AR Steering Worm Lower Bushing Assembly. Fits below the 7 tooth worm.	1	1928-early 1929	19.95 ea.
	A-3553-D Steering Worm Bearing Upper Race. 2 tooth.	1	1930-31	42.50 ea.

Part #	Description	Reqd.	Years	Price
<b>Steering</b>				
 A-3568-S	A-3568-S	1	1929-36	8.95 ea.
 A-3569	A-3569	1	1929-37	4.50 ea.
 A-3571	A-3571	2	1928-29	3.95 ea.
 A-3571-C	A-3571-C	2	1929-31	16.95 ea.
 A-3574-S	A-3574-S	1	1929-31	19.95 kit
 A-3575-B	A-3575-B	1	1928-29	97.50 ea.
 A-3575-C	A-3575-C	1	1929-31	89.95 ea.
 A-3575-W	A-3575-W	1	1929-31	1.50 ea.
 3575-C	A-3576-C	2	1929-31	4.95 ea.
 A-3581-A	A-3581-A	1	1928-29	2.75 set
 A-3581-AS	A-3581-AS		1928-29	5.95 ea.
 A-3581-B	A-3581-BS		1929-31	5.95 ea.
 A-3581-B	A-3581-B	1	1929-31	2.75 set
 A-3585	A-3585			7.95 ea.
 A-3586	A-3586	1	1929-36	2.95 ea.
 A-3587	A-3587	1	1/29-36	2.50 ea.
 A-3581-BS	A-3590	1	1928-31	39.95 ea.
 A-3590	A-3590-S	1	1928-31	39.95 ea.
 A-3592	A-3592	1	1928-31	2.95 set
 A-3600-AR	A-3600-AR	1	1928	179.95 ea.
 A-3600-BR	A-3600-BR	1	1928-29	179.95 ea.
 A-3600-C	A-3600-C	1	1928-29	179.95 ea.
 A-3600-E	A-3600-E	1	1930-31	184.95 ea.
 A-3609	A-3609	1	1929-48	1.00 ea.
 A-3610	A-3610	1	1928-48	1.00 ea.
 A-3616-BR	A-3616-BR	1	1928-29	75.00 ea.
 A-3616-CR	A-3616-CR	1	1929	75.00 ea.

All prices listed in catalog subject to change. Call for current prices.

# Model A Parts

Prices listed in catalog subject to change. Call for current prices.

Part #	Description	Reqd.	Years	Price
<b>Steering</b>				
A-3616-FR	Horn & Light Rod, 45-3/4". Ford Steering. 7 tooth box. Used from January 1930 thru March 1930.	1	1930	75.00 ea.
A-3616-GR	Horn & Light Rod, 44-31/32". Gemmer Steering. Used from Jan. 1930 - Feb. 1930.	1	1930	75.00 ea.
A-3616-H	Horn & Light Rod, 45-31/32". Gemmer Steering. Used Feb. 1930 to end. 2 tooth box. (90% of 1930-31's used this rod).	1	1930-31	75.00 ea.
A-3616-RK	Horn & Light Rod Repair Kit. This kit has wire, insulators & contacts to repair the internals of the horn and light rod.	1	1928-39	4.95 kit
A-3617	Horn Button Repair Kit. Renew your horn button assembly. Kit has new chrome button, escutcheon, spring and collar. (4 pcs.)	1	1928-29	28.95 kit
A-3618	Horn Button Repair Kit. Renew your horn button assembly. Kit has new black button, escutcheon, spring and collar. (4 pcs.)	1	1930-31	28.95 kit
A-3642/4	Light Switch Spring & Retainer Clip. Holds A-3643 in place.	1	1928-39	1.00 set
A-3643	Light Switch Spider. Fits end of light rod. Turns on lights.	1	1928-39	4.50 ea.
A-3644-T	Light Switch Spider Tool. Instructions included. A 'must have' tool.		1928-39	8.95 ea.
A-3647	Bail. Holds light switch A-11654 onto end of the steering column.	1	1928-36	1.95 ea.
<b>Rear Axle</b>				
A-4012	Rear Axle Housing Sleeve Bearing Surface. Rear bearing rides on this. Hardened. USA.	1	1928-48	32.95 ea.
A-4020	Rear Spring Bushing.	4	1928-31	.75 ea.
A-4027	Rear Axle Housing Bolt Set. Special head. Black oxide. (20 pc. set)	1	1928-32	26.00 set
A-4030	Differential Housing Special Headless Drain and Filler Plug. Passenger & Commercial.	2	1928-34	.75 ea.
A-4191-AR	Rear Axle Housing Cap Gasket. Used on the worm drive differential cap.	1	1928-29	2.25 ea.
A-4209-A	Ring Gear & Pinion Set. Standard. Ratio 3.78 to 1. (9:34) Mated & lapped for smooth performance. USA.	1	1928-32	469.95 set
A-4209-HS	Ring & Pinion Set. High Speed. 3.54 to 1 ratio. (11:39) Mated & lapped for smooth performance. USA.	1	1928-32	479.95 set
A-4215	Pinion Gear Set. Accurate to Ford print for strength and tolerance. (3 pc. set) This set also fits 1932 4 cyl.	1	1928-32	225.00 set
A-4221	Differential Pinion Bearing. Also fits B-4616.	4	1928-32	49.95 ea.
A-4221-SH	Differential Bearing Shim. .005.		1928-31	1.75 ea.
A-4222	Differential Bearing Cup. Fits B-4221.	2	1928-32	53.95 ea.
A-4235	Rear Axle Shaft and Gear. Accurate to Ford print for strength and tolerance. This also fits 1932 4 cyl.	2	1928-32	529.95 ea.

Meyer-Drake™ patterns & parts @ [www.meyerdrake.com](http://www.meyerdrake.com)

[www.gaslightauto.com](http://www.gaslightauto.com)



All prices listed in catalog subject to change. Call for current prices.

Part #	Description	Reqd.	Years	Price
<b>Rear Axle</b>				
A-4235-S	Rear Axle Shim Tapered. Fits in rear hub to alleviate worn axle surfaces.	2	1912-48	1.25 ea.
A-4235-WP	Wheel Puller. Screw on. Superior design will not strip the threads on your axle. Also useful on the steering wheel. Made in Ohio.	1	1912-48	4.95 ea.
A-4242	Rear Axle Shaft Castle Nut.	2	1909-48	1.00 ea.
A-4243	Rear Axle Key. Hardened steel. (Also fits Chevrolet 1916-32)	2	1912-48	.50 ea.
A-4245	Rear Axle & Drive Shaft Grease Seal. Fits both axle housing & drive shaft housing. (Taper toward differential).	3	1928-48	3.95 ea.
A-4245-B	Rear Axle Inner Grease Seal. Truck.	2	1930-34	9.95 ea.
A-4246	<b>NEW</b> Economy Seal Driver has pipe threads. Tread in your own pipe. USA			10.95 ea.
A-4500	Rear End & Universal Joint Gasket Set. (9 pcs.) Fits all Model A's except AA. Also 1932 Model B.	1	1928-32	5.95 set
A-4500-AR	Worm Drive Rear End Gasket Set. For the worm drive rear end used by heavy trucks.	1	1928-29	16.95 ea.
A-4500-B	Bevel Gear Rear End Gasket Set. For the bevel gear rear end used on the heavy trucks.	1	1929-31	18.95 set
A-4506	Torque Tube to Axle Bolt Set. Black oxide. (6 pc. set)	1	1928-32	5.95 set
A-4508	Radius Rods to Torque Tube Bolt Set.	1	1928-32	3.95 set
A-4515-B	Universal Joint Housing Gasket Set. Fits U-joint caps on Passenger Cars & Pickups. AA Trucks using bevel gear differentials.	1	1928-31	1.95 set
A-4516-A	Universal Joint Housing Cap Felt Seal. (Short style takes 2).	2	1928-48	.50 ea.
A-4517	U-Joint Housing Bolt Set. Original style bolts, nuts & lock washers. (22 pcs.)	1	1928-31	15.95 set
A-4599-A	Torque Tube Gasket for Worm Drive. Fits the torque tube flange on the worm drive rear end.	1	1919-29	2.95 ea.
A-4605	Drive Shaft Special Nut. Holds pinion gear to drive shaft.	1	1911-31	2.95 ea.
A-4606	Drive Shaft Pinion Gear Key.	1	1928-32	.75 ea.
A-4616	Drive Pinion Bearing Cup. The double cup holds 2 A-4221 bearings at differential housing. This also fits 1932 4 cyl.	1	1928-32	72.95 ea.
A-4634	Drive Pinion Bearing Nut.	2	1928-50	2.50 ea.
A-4636	Pinion Bearing Lock Nut Washer.	1	1928-50	1.75 ea.
A-4645/55	Drive Shaft Roller Bearing & Sleeve Set.	1	1928-48	25.95 set
<b>Frame</b>				
A-5092-FL	Float-A-Motor Kit. Accessory to reduce vibration. Rubber pads on cast iron brackets.	1	1928-31	79.95 kit
A-5092/94-S	Rear Motor Mount Pads & Hardware. (Complete 28 pc. set.)	1	1928-31	12.95 set
A-5092-MB	Rear Motor Mount Hardware Only.	1	1928-31	7.50 set
A-5095	Rear Motor Mount Plate & Rubber Pad. Fits on outside of frame with the flat rubber pad between it & frame. Passenger & Pickup.	2	1928-31	5.95 set



A-4245



A-4235-S



A-4500



A-4616



A-4634

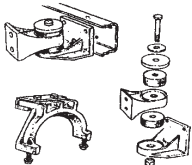











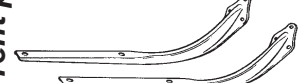
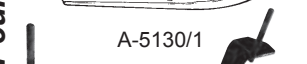





A-5092-FL

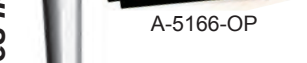

A-5092/94-S

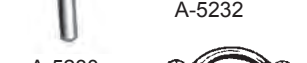
# Model A Parts

All prices listed in catalog subject to change. Call for current prices

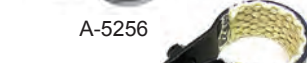
Part #	Description	Reqd.	Years	Price
<b>Frame</b>				
 A-5097	Rear Motor Mount / Flywheel Bolt Set. This set bolts rear motor mounts to flywheel housing. Bolt heads are drilled for safety wiring. (8 pcs.)	1	1928-31	4.50 set
 A-5125-A	Running Board Brackets. Front. Stamped steel.	1	1928-31	69.95 pr.
 A-5125-MB	Running Board Bracket Bolt Set. (36 pcs.)	1	1928-31	4.25 set
 A-5130/1	Running Board Brackets. Rear. Stamped steel.	1	1928-31	69.95 pr.
<b>Battery Support</b>				
 A-5151	Battery Support Assembly. USA. Duplicate of factory original design. Black powder coated.	1	1928-31	27.95 ea.
 A-5151-MT	Battery Box Mounting Set.	1	1928-31	1.25 ea.
 A-5152-C	Battery Support Base Plate w/ Clipped Corners.	1	1928-31	4.95 ea.
 A-5153-S	Battery Support Base Plate w/ Square Corners.	1	1928-31	4.95 ea.
 A-5163-B	Battery Hold Down Clamps. 14 gauge steel.	1	1929-32	3.95 pr.
 A-5166	Battery Hold Down Frame. Die stamped steel with embossed corners. USA. Black powder coated.	1	1928-32	9.95 ea.
 A-5166-OP	Battery Hold Down Frame for Optima Battery. Heavy construction fits original box.	1	1928-31	10.95 ea.
<b>Muffler</b>				
 A-5230-HSS	Muffler Heat Shield, Stainless. Bolts to your exhaust & directs the heat away from the floorboards. USA.	1	1928-31	49.95 ea.
 A-5230-P	Original Steel Muffler. Made from the original Ford blueprints to duplicate the muffler that Ford made. 3 baffles & 172-1/4" porting holes create the Original 'A' Sound. Cold rolled steel construction. Painted w/ black hi-temp paint.	1	1928-31	280.00 ea.
 A-5230-S	Stainless Steel Muffler. Made from original blueprints. 100% Stainless w/ 172-1/4" portings holes & 3 baffles, eliminating back pressure. Creates the 'A' sound. Rust free service.	1	1928-31	335.00 ea.
 A-5231	Copper, Tapered Exhaust Seal with HI-TEMP Filler. Seals manifold to exhaust pipe. 4 cyl.	1	1928-34	2.95 ea.
 A-5232	Exhaust Manifold Sleeve. (Insert larger end into manifold & small end into neck of muffler. Using A-5231 will prevent leakage).	1	1928-31	5.95 ea.
 A-5251	Exhaust Manifold Clamp of Ductile Iron. With original mold letter & number which faces down when installed. USA.	1	1928-34	15.95 ea.
 A-5251-MG	Exhaust Manifold to Muffler Gasket.	1	1928-34	1.00 ea.
 A-5251-X	<b>NEW</b> Exhaust Manifold Clamp without nuts. Bottom half tapped for easy installation..			14.95 ea.
 A-5256	Tail Pipe Clamp w/Bolt & Nut. Mounts tail pipe to frame.	1	1928-31	3.50 ea.
 A-5256-E	Insulated Tail Pipe Clamp. This clamp relieves the stress on the manifold & muffler as heat builds up. USA.	1	1928-31	14.95 ea.





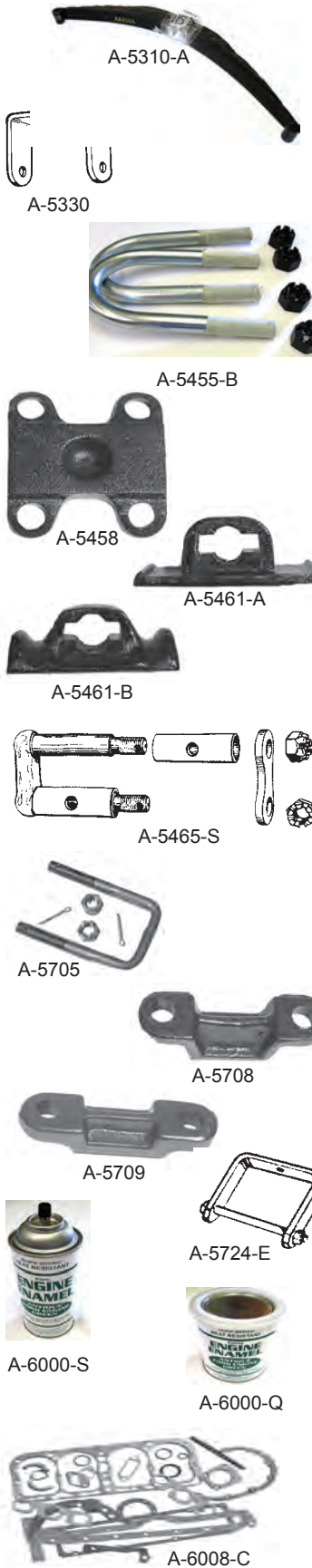











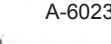

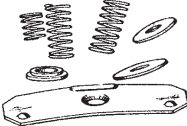

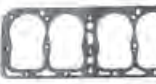
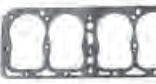
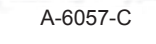



All prices listed in catalog subject to change. Call for current prices.

Part #	Description	Reqd.	Years	Price
<b>Front &amp; Rear Springs</b>				
A-5310-A	Front Spring Assembly with Clamps. 10 leaves. Passenger & Commercial.	1	1928-31	115.95 ea.
A-5330	Front Spring Clamps. Passenger & Commercial. (Also fits 1928-29 AA's)	1	1928-34	8.95 pr.
A-5346	Front Spring Center Bolt & Square Nut. 5/16 x 18 x 5 1/2.	1	1928-48	1.25 ea.
A-5455	Front Spring Square Top U-Bolts w/ Nuts and Cotter Pins. This 10 pc. set used w/ A-5461-A from start to Feb. 1930.	1		15.95 set
A-5455-B	Front Spring Round Top U-Bolt set w/ Nuts & Cotter Pins. This 10 pc. set used w/ A-5461-B from Feb. 1930 thru 1934.	1		19.95 set
A-5455-N	Front Spring U-Bolt Nut Set. As included in A-5455 & A-5455-B U-bolt sets.	1	1928-34	1.50 set
A-5458	Front Spring Center Lower Plate. (U-bolts pass thru the plate to hold spring up in cross member)	1	1928-34	8.95 ea.
A-5461-A	Crank Handle Guide. Square top style. Fits on top of front cross member & uses the square top U-bolts A-5455. From start to Feb. 1930.	1		13.95 ea.
A-5461-B	Crank Handle Guide. Round top style. Fits on top of front cross member & uses the round top U-bolts A-5455-B. From Feb. 1930 thru 1934.	1		10.95 ea.
A-5465-S	Front Spring Shackle Set. Steel.	1	1928-31	19.95 set
A-5560-B	Rear Spring Assembly. 8 Leaf. Phaetons, All Coupes & 1929-31 Cabriolets.	1	1928-31	425.00 ea.
A-5560-C	Rear Spring Assembly. 10 Leaf. All Tudors, Fordors & Pickup Trucks.	1	1928-31	650.00 ea.
A-5580	Rear Spring Center Bolt & Nut. 3/8 16 x 5 3/4.	1	1928-34	1.95 set
A-5630-S	Rear Spring Shackle Set. Steel.	1	1928-31	19.95 set
A-5705	Rear Spring U-Bolt Set w/ Nuts & Cotter Pins. 10 pcs. Used w/ either A-5708 or A-5709 to hold spring in rear crossmember.	1	1928-31	14.95 set
A-5706	Rear Spring U-Bolt Nut. As included in U-bolt sets. (4 pcs.)	1	1928-48	4.25 set
A-5708	Rear Spring Clip Bars. Holds the 7 or 8 leaf rear spring up in crossmember. 1-1/8" high.	1	1928-31	13.95 pr.
A-5709	Rear Spring Clip Bars. Holds the 10 or 12 leaf rear spring up in crossmember. 5/8" high.	1	1928-31	13.95 pr.
A-5724-E	Rear Spring Clamps. Pass. & Comm.	1	1928-34	4.25 pr.
<b>Engine Cylinder</b>				
A-6000-S	Engine Green Paint. Spray can.	1	1925-41	8.00 ea.
A-6000-Q	Engine Green Paint. 1 qt. can.	1	1925-41	36.95 qt.
A-6008	Engine Gasket Set, less Head Gasket.	1	1928-31	15.95 set
A-6008-C	Engine Gasket Set with Copper Head Gasket. (Seam around cylinder holes face up.)	1	1928-31	38.95 set
A-6008-M	Engine Gasket Set with Modern Head Gasket.	1	1928-31	52.95 set
A-6017	Timing Gear Side Cover.	1	1928-32	5.95 ea.
A-6018	Timing Gear Side Cover Gasket.	1	1928-34	.65 ea.
A-6019-S	Timing Gear Front Cover Bolts and Lockwashers (14 pcs.)	1	1928-31	4.95 set

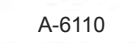

# Model A Parts

All prices listed in catalog subject to change. Call for current prices.

Part #	Description	Reqd.	Years	Price
<b>Engine Cylinder</b>				
 A-6020	A-6020 Timing Gear Front Cover Gasket.	1	1928-34	.95 ea.
 A-6023	A-6023 Timing Pin. Machined as original.	1	1928-34	4.95 ea.
 A-6030-A	A-6030-A Front Engine Yoke Bracket. New 1 piece forging as original.	1	1928-31	34.95 ea.
 A-6030-MB	A-6030-MB Front Engine Yoke Mounting Bolts with Lock Washers. (4 pcs.)	1	1929-31	2.50 set
 A-6031-FAM	A-6031-FAM Front Float A Motor Kit.	1	1928-31	64.95 set
 A-6034	A-6034 Front Motor Mount Bushing. Brass.	1	1929-31	1.95 ea.
 A-6036	A-6036 Front Motor Mount Kit. Original style kit including A-6034. (8 pc. set)	1	1928-31	6.95 kit
 A-6051-C	A-6051-C Copper Head Gasket. (Seam around cylinder holes face up)	1	1928-31	30.00 ea.
 A-6051-M	A-6051-M Modern Steel Core Head Gasket. Outer layers of high density silicone coated gasket material. High temperature silicone beads around all water passages and head studs. No sealants needed for head installation.	1	1928-31	39.95 ea.
 A-6062	A-6062 <b>NEW</b> Head Stud Drill Out Kit.			43.95 ea.
 A-6064-T	A-6064-T Head Nut Torque Tool. Used to torque the nut behind the distributor.	1	1928-34	24.95 ea.
 A-6065-RK	A-6065-RK <b>NEW</b> Head Stud Repair Kit. Complete with everything to repair head, or manifold studs, less a 29/64" drill bit.			36.95 ea.
 A-6065-RK2	A-6065-RK2 <b>NEW</b> Thread Repair Inserts (Helicoils) set of 6.			12.95 ea.
 A-6066	A-6066 Cylinder Head Stud, 3-15/32" long.	12	1928-34	2.50 ea.
 A-6067	A-6067 Cylinder Head Stud, 5-23/32" long.	2	1928-31	1.95 ea.
 A-6068	A-6068 Cylinder Head Nut. Cadmium plated. Exact duplicate. (Torque 50 ft. lbs.)	14	1928-34	.35 ea.
<b>Pistons &amp; Rods</b>				
 A-6110	A-6110 Aluminum Piston Set w/ Fitted Pins. 4 cyl. Standard.	1	1928-34	109.95 set
 A-6110-20	A-6110-20 Aluminum Piston Set w/ Fitted Pins. 4 cyl. .020.	1	1928-34	109.95 set
 A-6110-30	A-6110-30 Aluminum Piston Set w/ Fitted Pins. 4 cyl. .030.	1	1928-34	109.95 set
 A-6110-40	A-6110-40 Aluminum Piston Set w/ Fitted Pins. 4 cyl. .040.	1	1928-34	109.95 set
 A-6110-60	A-6110-60 Aluminum Piston Set w/ Fitted Pins. 4 cyl. .060.	1	1928-34	109.95 set
 A-6110-80	A-6110-80 Aluminum Piston Set w/Pins. .080	1	1928-34	109.95 set
 A-6110/100	A-6110/100 Aluminum Piston Set w/ Fitted Pins. 4 cyl. .100.	1	1928-34	109.95 set
 A-6110/125	A-6110/125 Aluminum Piston Set w/ Fitted Pins. 4 cyl. .125 Oversize.	1	1928-34	109.95 set
 A-6150	A-6150 Piston Ring Set for A-6110 Pistons. 4 cyl. Standard.	1	1928-34	29.95 set
 A-6150-20	A-6150-20 Piston Ring Set for A-6110 Pistons. 4 cyl. .020.	1	1928-34	29.95 set
 A-6150-30	A-6150-30 Piston Ring Set for A-6110 Pistons. 4 cyl. .030.	1	1928-34	29.95 set
 A-6150-40	A-6150-40 Piston Ring Set for A-6110 Pistons. 4 cyl. .040.	1	1928-34	29.95 set

Part #	Description	Reqd.	Years	Price
<b>Pistons &amp; Rods</b>				
A-6150-60	Piston Ring Set for A-6110 Pistons. 4 cyl. .060.	1	1928-34	29.95 set
A-6150-80	Piston Ring Set, 4 cyl. .080	1	1928-34	29.95 set
A-6150/100	Piston Ring Set for A-6110 Pistons. 4 cyl. .100.	1	1928-34	29.95 set
A-6150/125	Piston Ring Set for A-6110 Pistons. 4 cyl. .125.	1	1928-34	29.95 set
A-6207-L	Piston Pin Bushing. Long. For end lock pistons.	4	1928-34	1.95 ea.
A-6220-S	Connecting Rod Shim Set. Laminated. (8 pcs.)	1	1928-34	9.95 set
A-6251	<b>NEW</b> Camshaft Nut Wrench Stock Nut.			18.95 ea.
A-6253	Camshaft Dowell Pin. Fits all 4 cyl. engines	2	1909-34	1.50 ea.
A-6256	Fiber Timing Gear. Fits on camshaft. Standard. 4 cyl.	1	1928-34	59.95 ea.
A-6256-A	Aluminum Camshaft Timing Gear. This gear is made of 356 T6 alloy. Accurately machined by one of the top timing gear cutters in the USA. 4 cyl.	1	1928-34	84.95 ea.
A-6259	Camshaft Retaining Nut. Holds fiber timing gear on end of camshaft. Right hand thread. (Torq to 100#).	1	1928-34	6.25 ea.
A-6259-M	Hex Type Camshaft Nut. (Use a standard wrench)	1	1928-34	10.95 ea.
A-6275/76	Camshaft Thrust Plunger & Spring Set. (Grease end when installing).	1	1928-34	3.95 set.
A-6306	Crankshaft Timing Gear, 4 cyl.	1	1928-34	16.95 ea.
A-6306-K	Crankshaft Timing Gear Key. Holds A-6306 in place.	1	1928-37	.50 ea.
A-6310	Crankshaft Oil Slinger. (The rolled edge faces toward the engine)	1	1928-34	3.25 ea.
A-6312	Crankshaft Pulley. 1 piece style. 4 cyl. (Requires radiator to be unbolted to install).	1	1928-34	32.50 ea.
A-6312-A	Crankshaft Pulley. 2 piece style. 4 cyl. (Aids installation when engine is in car).	1	1928-34	26.95 ea.
A-6319	Crankshaft Ratchet Nut. Accepts A-17036 to turn engine over for timing or starting.	1	1928-38	21.95 ea.
A-6328-A	Oil Drain Tube. 5/16" O.D. (Braze or spot weld to rear main cap as it can vibrate loose in your pan).	1	1928-30	2.95 ea.
A-6328-B	Oil Drain Tube. 3/8" O.D. (Same as above)	1	1930-31	3.95 ea.
A-6335	Rear Main Bearing Oil Seal. Aluminum.	1	1928-31	12.95 ea.
A-6335-Q	Rear Main Bearing Oil Seal. Aluminum.	1	1928-31	15.95 ea.
A-6336-S	Rear Main Seal. Nitrile radial lip for positive seal. Instructions included.	1	1928-31	15.95 ea.
B-6336-S	Rear Main Seal. Nitrile radial lip for positive seal. 4 cyl. Instructions included. (Also 32-53 V-8)	1	1932-53	14.95 ea.
A-6337	2 pc. Cork/Neoprene rear Main Seal. (Crankshaft will require machining w/this seal.) Installation instructions included. USA.	1	1928-31	18.95 ea.
A-6340/46-S	Main Bearing Shim Set. (6 pcs.)	1	1928-31	12.50 set

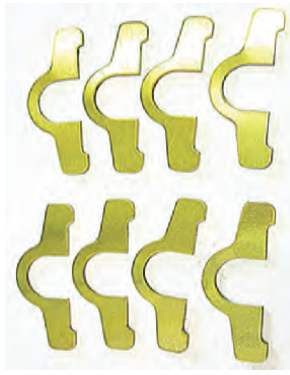

A-6220-S



A-6256



A-6259



A-6259-M



A-6306



A-6275/76



A-6310

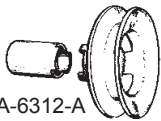

A-6312-A



A-6319

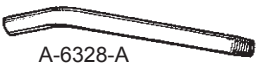

A-6328-A



A-6328-B



A-6336-S

All prices listed in catalog subject to change. Call for current prices.

# Model A Parts

All prices listed in catalog subject to change. Call for current prices.

Part #	Description	Reqd.	Years	Price
<b>Flywheel &amp; Valves</b>				
A-6380	Flywheel Bolts w/ Drilled Head. Hardened. (Set of 4)	1	1928-48	18.95 set
 A-6384	Flywheel Ring Gear. Hardened steel. (Tapered teeth face rear of engine when installed. Heat with rose bud tip.)	1	1928-48	32.95 ea.
A-6387	Flywheel to Crankshaft Dowel.	1	1928-48	4.25 pr.
A-6394	Flywheel Housing Bolt Set. Bolts flywheel housing block & accelerator assembly to engine block (8 pcs.).	1	1928-31	4.25 set
A-6396	Flywheel Housing Gasket.	1	1928-32	.50 ea.
A-6398	Flywheel Inspection Plate. USA.	1	1928-31	9.95 ea.
A-6398-MB	Flywheel Inspection Plate Bolt Set.	1	1928-31	1.00 set
A-6400	Flywheel Housing Shims. The U-shaped shims used on 2 bolts at rear of engine block. (Buy 2 or 3 pairs to shim properly.) 4 cyl.		1928-34	.95 pr.
A-6500	Adjustable Valve Tappet Set. Double lock. USA. (Set of 8)	1	1928-34	59.95 set
A-6500-S	Adjustable Tappets. Single lock. Easier to adjust. Speeds up installation. 4 cyl.	1	1928-34	125.00 set
A-6501-SL	Single Split-Nut Tappet Set. Locking Style. Fully hardened steel. 4 cyl. (Set of 8)	1	1928-34	129.95 set
A-6505	Valve. Stainless steel. 4 cyl. USA. Intake or exhaust uses the same valve.	8	1928-34	9.50 ea.
A-6505-M	Modern Valve Set. Stainless. No. modifications required. Everything included.	1	1928-34	149.95 kit
A-6510	Valve Guides. 2 piece style. 4 cyl.	8	1928-34	9.95 pr.
A-6510-T	Valve Guide Remover Tool.	1	1928-34	5.95 ea.
A-6510-TKR	Valve Guide Remover Tool. A duplicate of the KR Wilson tool.	1	1928-34	15.95 ea.
A-6513	Valve Springs. 4 cyl. (Set of 8)	1	1928-34	4.95 set
A-6514	Valve Spring Keeper. Holds spring to valve.	8	1928-34	1.50 ea.
A-6521	Valve Cover Gasket.	1	1928-31	1.95 ea.
<b>Oil Pump &amp; Pan</b>				
A-6551	Oil Pump Drive Gear. 4 cyl. Also drives distributor.	1	1928-34	29.95 ea.
A-6560	Oil Pump Drive Gear Bearing. Holds A-6551. 4 cyl. (A worn unit increases wear on all parts from pump to distributor) USA.	1	1928-34	24.95 ea.
A-6561	Oil Pump Drive Gear Sleeve w/ Pin. Drilled & hardened. 4 cyl.	1	1928-34	2.95 ea.
A-6562	Oil Pump Retainer Set Screw. Holds oil pump body in position in block. 4 cyl.	1	1928-34	.50 ea.
A-6570	Oil Pump Drive Gear Retainer Spring.	1	1928-34	1.25 ea.
A-6600	Oil Pump Repair Kit. 2 new gears & new shaft, 2 bushings. Shaft dia. 1/2". (Not for use with pumps before May '28)	1	1928-34	34.95 kit
A-6600-B	New Oil Pump Complete.	1	1928-31	169.95 ea.
A-6612	Oil Pump Body Bushing.	2	1928-53	1.00 ea.
A-6619	Oil Pump Cover Plate Gasket. The thin paper gasket for the oil pump steel bottom plate. 4 cyl.	1	1928-31	.50 ea.
A-6620	Oil Pump Retaining Spring.	1	1928-34	1.00 ea.



A-6398



A-6398-MB



A-6500

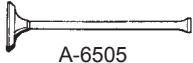

A-6505



A-6505-M



A-6510



A-6510-T



A-6513



A-6514



A-6551



A-6560



A-6561

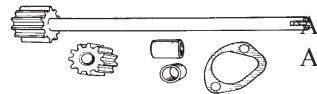

A-6600



A-6600-B

All prices listed in catalog subject to change. Call for current prices.

Part #	Description	Reqd.	Years	Price
<b>Oil Pump &amp; Pan</b>				
A-6623	Oil Pump Screen. Circular mesh with edges fully soldered. 4 cyl. USA.	1	1928-34	2.95 ea.
A-6626	Oil Pump Screen Cover Gasket.	1	1928-34	.25 ea.
A-6646	Oil Return Pipe Bolts w/ Copper Washers. (4 pc. set)	1	1928-31	1.95 set
A-6648	Oil Return Pipe Flange Gaskets.	1	1928-31	1.00 pr.
A-6700	Timing Cover & Front Oil Pan Packing. (Soak thoroughly in oil).	1	1928-34	2.95 pr.
A-6700-B	Front Crankshaft Seal. (Install with lip facing rear of engine. Smooth seal rubbing surface required). No modifications to engine required. 4 & 8 cyl.	1	1928-53	14.95 ea.
A-6730	Oil Pan Drain Plug with Copper Gasket.	1	Mid'28-38	4.95 set
A-6734-C	Copper Gasket. Used on the oil pan drain plug. Use as spare when changing oil. Included with A-6730.	1	Mid'28-38	1.25 ea.
A-6750	Dip Stick, 4 cyl. Round loop handle.	1	1928-34	4.95 ea.
A-6763-A	Oil Filler Pipe with Internal Baffles.	1	1928-31	6.95 ea.
A-6764	Oil Breather Set. Relieves oil blow by odor.	1	1928-31	44.95 set
A-6766-A	Oil Filler Cap. 4 tang style. Plain steel.	1	1928-31	3.95 ea.
A-6766-C	Oil Filler Cap. Chrome plated.	1	1928-31	4.50 ea.
A-6775/78-S	Model A Motor Aprons. (Engine pans).	1	1928-31	69.95 pr.
A-6780	Motor Apron Bolt Set. (18 pcs.)	1	1928-31	1.95 set
A-6781	Oil Pan Gasket Set. (4 pcs.)	1	1928-31	6.95 set
A-6781-C	Cork Oil Pan Gasket Set.	1	1928-31	9.95 set
A-6782	Oil Pan & Valve Cover Bolt Set. Black oxide finish. (60 pc. set)	1	1928-31	13.00 set
<b>Transmission</b>				
A-7000-BB	Emergency Brake Lever Boot. Black	1	1928-31	4.95 ea.
A-7000-GB	Gearshift Boot. Black.	1	1928-39	4.95 ea.
A-7006	Transmission Case Special Square Head Filler and Drain Plug. Passenger & Commercial.	2	1928-38	.80 ea.
A-7017-B	Main Drive Gear. USA.	1	1928-31	174.95 ea.
A-7025-SR	Main Drive Gear Bearing with Snap Ring. (Inside seal removeable w/ knife point). Fits 7017 gear. Used Sept. 1929 thru 1948.	1	1929-48	12.95 ea.
A-7040	Main Drive Gear Baffle, Oil Slinger. (Center of baffle lays flat against bearing.) Use A-1180 to hold in place. Sept. 1929-On.	1		1.95 ea.
A-7060	Transmission Main Shaft. USA.	1	1928-31	124.95 ea.
A-7063	Main Shaft Pilot Bearing Spacer. Slides over end of A-7060. This prevents damage to A-7118 bearing.	1	1928-31	.75 ea.
A-7065-SR	Main Drive Gear Bearing with Snap Ring. (Inside seal removeable w/ knife point). Fits 7060 shaft. Used Sept 1929 thru 1948.	1	1929-48	21.95 ea.
A-7070	Transmission Rear End & Steering Box Grease. Modern type SAE 140 w/ coating additive.		1912-39	10.95 qt.
A-7080-B	Baffle for Trans. Main Shaft Bearing. USA.	1	1929-31	119.95 ea.
A-7090	Universal Joint Assembly. Pass. & Comm.	1	1928-48	119.95 ea.



A-6623



A-6700-B



A-6730



A-6763-A



A-6775/78-S



A-7000-BB

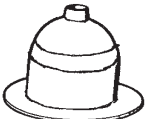

A-7000-GB



A-7006



A-7060



A-7070



A-7017-B

# Model A Parts

All prices listed in catalog subject to change. Call for current prices.



A-7100

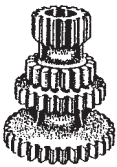

A-7113

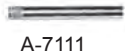

A-7111



A-7118



A-7121



A-7141



A-7213



A-7213-C



A-7222-C



A-7209



A-7506-S



A-7510-S

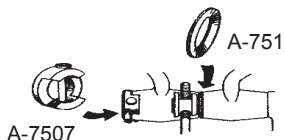

A-7507

Part #	Description	Reqd.	Years	Price
<b>Transmission</b>				
A-7095	Universal Joint Retainer Bolt & Washer. Holds U-joint A-7090 to end of A-7060 main shaft & spring washer. (tabbed side of washer goes on first)	1	mid'28-48	1.75 ea.
A-7100	Low & Reverse Sliding Gear. USA.	1	1928-31	94.95 ea.
A-7101	Second & High Sliding Gear. USA	1	1928-31	124.95 ea.
A-7111	Transmission Counter Shaft. USA	1	1928-31	9.95 ea.
A-7111-S	Transmission Shaft Seals for Both Shafts. End that greasy mess on your floor.	1	1928-31	19.95 kit
A-7113	Cluster Gear. Made in USA.	1	1928-31	315.00 ea.
A-7115	Cluster Gear Spacer. Installed between A-7118 & A-7121, inside A-7113.	1	1928-31	1.50 ea.
A-7118	Main Shaft & Cluster Bearing. Short. Fits A-7060 & A-7111 shafts. 1-7/16" long.	2	1928-50	9.95 ea.
A-7119	Cluster Shaft Thrust Washer.	2	1928-1/29	6.50 ea.
A-7121	Countershaft Roller Bearing. Fits A-7111 & A-7113. 1-11/16" long.	1	1928-50	4.95 ea.
A-7140	Transmission Reverse Idler Shaft. USA.	1	1928-31	7.95 ea.
A-7141	Reverse Idler Gear. USA.	1	1928-31	109.95 ea.
A-7153	Transmission Gasket Set.	1	1928-31	2.95 set
A-7160	Clutch Housing to Trans. Case Bolts. Black oxide. (8 pc. set)	1	1928-31	2.25 set
A-7209	Gear Shift Lever Assembly. Chromed.	1	1928-31	48.95 ea.
A-7213	Gear Shift Knob. Black. Original design. Passenger & Commercial.	1	1928-36	3.95 ea.
A-7213-C	Shift Knob with Clock. Black knob with Quartz Clock embedded in mushroom top. (Remove clock to change battery) <i>A neat Gift item.</i>	1	1928-36	34.95 ea.
A-7222-C	Gear Shift Housing.	1	1929-31	29.95 ea.
A-7225	Trans. Housing Cover Bolt Set. (12 pcs.)	1	1928-31	1.95 set
A-7230	Transmission shifting fork.	1		36.95 ea.
A-7233/4	Shifter Plungers & Spring Set. (Mount in trans. cover & slip into notches in the shift rails.) Worn plungers allow car to slip out of gear. (3 pc. set)	1	1928-37	4.95 set
A-7240	<b>NEW</b> Shift Fork Shaft, Low & Reverse.			17.95 ea.
A-7241	<b>NEW</b> Shift Fork Shaft, 2nd & High.			18.95 ea.

## Clutch

A-7503	Clutch Housing to Flywheel Housing Bolt Set. Black oxide finish. (22 pcs.)	1	1928-31	4.50 set
A-7506-B	Clutch & Brake Pedal Shaft.	1	1928-31	5.00 ea.
A-7506-S	Pedal Shaft Set w/ Bushings, Rivets & Washers. (8 pcs.)	1	1928-31	12.95 set
A-7507	Pedal Shaft Collar & Rivet. Fits at end of A-7506.	1	1928-31	3.95 set
A-7508	Clutch & Brake Pedal Bushing. 4 cyl. (Use 4 on A-7506 shaft & 2 on A-7510 shaft)		1928-34	1.75 ea.
A-7509-A	Pedal Shaft Pin.	2	1928-31	.50 ea.
A-7509-B	Pedal Collar Pin. Used with A-7507 collar.	1	1928-31	.75 ea.
A-7510	Clutch Release Shaft.	1	1928-31	5.95 ea.
A-7510-S	Clutch Release Shaft Set w/ Bushings & Pins. (5 pc. set)	1	1928-31	8.95 set
A-7512	Pedal Shaft Spring Washer.	1	1928-31	.50 ea.



All prices listed in catalog subject to change. Call for current prices.

Part #	Description	Reqd.	Years	Price
<b>Clutch</b>				
A-7513-B	Clutch Release Shaft Pin.	2	1928-50	.50 ea.
A-7515	Clutch Shaft Release Fork. Assists in disengaging clutch pressure plate. Fits all except 60 hp.	1	1928-48	21.95 ea.
A-7515-K	Clutch Release Fork Shaft Key. Used with multiple clutch through early 1929.	1	1928-29	.35 ea.
A-7521-S	Clutch Adjusting Shaft Yoke & Trunnion Nut.	1	1929-31	15.95 set
A-7522-B	Clutch Adjusting Shaft Trunnion Nut. (Turn nut clockwise to decrease clearance between clutch & pressure plate).	1	1929-31	1.95 ea.
A-7550	Clutch Disc. Assy. 9" dia. Made in USA. Fits all except 60 hp.	1	1928-40	69.95 ea.
A-7550-T	Clutch Alignment Tool. Handy device to center clutch disc when being installed.	1	1929-40	4.95 ea.
A-7561-B	Clutch Release Bearing Hub.	1	1929-31	29.95 ea.
A-7562	Clutch Release Bearing Spring.	1	1929-31	1.25 ea.
A-7563	Pressure Plate, 9". Rebuilt. <b>Sold Exchange Only.</b> (1928-40 except 60 hp V-8) Not for 1928 multiple disc style.	1	1928-40	109.95 ex.
A-7563-MB	Pressure Plate Mounting Bolt Set. The bolt & washer set to bolt the pressure plate to the flywheel. (24 pcs.) Fits Model A, B & V-8 (except 60 hp.)	1	1928-40	2.95 set
A-7580	Clutch Release (Throwout) Bearing. USA. 4 cyl. & 85/100 hp.	1	1929-48	21.95 ea.
A-7600	Clutch Pilot Bearing. Double shielded. Fits in flywheel.	1	1928-75	3.50 ea.
<b>Radiator</b>				
A-8005-AHD	Radiator Assembly. Heavy Duty. A 33% increase in fins per square inch. Provides cooler running temperature. USA.	1	1928-29	649.95 ea.
A-8005-AR	Radiator Assembly. Flat fin & tube core. 3 Rows 2-1/4" thick. 5 1/2 fins per square inch.	1	1928-29	589.95 ea.
A-8005-B	Radiator Assembly. Flat fin & tube core. 3 Rows 2-1/4" thick. 5 1/2 fins per square inch.	1	1930-31	589.95 ea.
A-8005-BHD	Radiator Assembly. Heavy Duty. A 33% increase in fins per square inch. Provides cooler running temperature. USA.	1	1930-31	649.95 ea.
A-8028-MK	Stone Guard Mounting Kit. Stainless steel mounting clips, screws and rubber grommets. (8 pcs.) (This set is included in all the stone guard sets we sell.)	1	1928-31	9.95 kit
A-8029	Radiator Stone Guard. Polished stainless.	1	1928-29	160.00 ea.
A-8030	Radiator Stone Guard. Polished stainless.	1	1930	160.00 ea.
A-8031	Radiator Stone Guard. Polished stainless.	1	1931	235.00 ea.
A-8080	Radiator Plaque Mounting Set. Stainless.	1	1928-31	1.95 set
A-8100-AR	Radiator Cap. Threaded style. Chrome plated brass.		1928-29	17.95 ea.
A-8100-C	Radiator Cap. Stainless steel. Eaton design.	1	1930-31	19.95 ea.
A-8110-AR	Radiator Cap Gasket. Die cut leather.	1	1928-29	.50 ea.
A-8110-B	Radiator Cap Gasket. Die cut leather.	1	1930-31	.50 ea.



A-7550



A-7550-T

A-7562



A-7580



A-8031















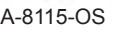
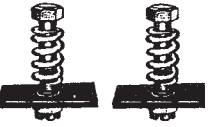









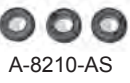
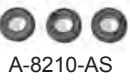

A-8100-AR

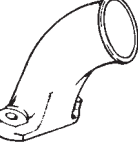
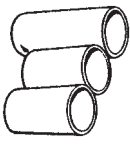
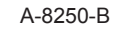

A-8100-C

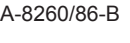
# Model A Parts

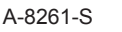
All prices listed in catalog subject to change. Call for current prices.

Part #	Description	Reqd.	Years	Price
<b>Radiator</b>				
 A-8115	A-8115 Radiator Drain Petcock. Replacement style.	1	1909-34	9.95 ea.
 A-8115-OS	A-8115-OS Radiator Drain Petcock. Leak proof. Exact duplicate of original. Solid brass. USA. Used with A-8291.	1	1909-34	13.95 ea.
 A-8130	A-8130 Radiator Mounting Kit. Springs, pads, bolts & nuts. (8 pc. set)	1	1928-48	6.95 set
 A-8133	A-8133 Radiator Brace Rods w/ Lock Washers & Nuts. Zinc plated.	1	1928-31	19.00 pr.
 A-8133-SS	A-8133-SS Radiator Brace Rods. Polished stainless steel. Nuts & lock washers included.	1	1928-31	32.95 pr.
 A-8140/41-S	A-8140/41-S Radiator Brace Rod Brackets on Firewall. Stainless steel. Passenger & Pickup.	1	1928-34	9.95 pr.
 A-8200-AC	A-8200-AC Radiator Shell. Chrome plated.	1	1928-29	229.95 ea.
 A-8200-AS	A-8200-AS Plain Steel Radiator Shell. No holes for that smooth Hot Rod Look.	1	1928-29	169.95 ea.
 A-8200-SS	A-8200-SS Radiator Shell. Polished stainless steel. With painted upper & lower insert areas. Set. Black oxide. (12 pcs.)	1	1931	589.95 ea.
 A-8203	A-8203 Radiator to Radiator Shell Mounting Screw	1	1928-29	1.95 set
 A-8204	A-8204 Radiator to Radiator Shell Mounting Screw Set. (12 pcs.)	1	1930-35	1.95 set
 A-8210-AS	A-8210-AS Radiator Shell Grommet Set. For horn & light conduits.	1	1928-29	1.00 set
 A-8210-BS	A-8210-BS Radiator Shell Grommet Set. For horn & light conduits.	1	1930-31	1.50 set
 A-8212-A	A-8212-A Radiator Shell Emblem. Blue porcelain.		1928-30	16.95 ea.
 A-8212-AC	A-8212-AC Radiator Emblem. Blue porcelain. This fastens to shell with a special clip held by lockwasher and brass nut.	1	1928-30	32.50 ea.
 A-8212-B	A-8212-B Radiator Emblem. Stainless steel oval, stamped in script with black enamel lettering.	1	1931	17.95 ea.
 A-8216-A	A-8216-A Crank Hole Cover w/ Rivet. Polished stainless.	1	1928-29	2.95 set
 A-8212-A	A-8212-A Crank Hole Cover w/ Rivet. Polished stainless.	1	1930-31	2.95 set
 A-8220-C	A-8220-C Hood Rod Retainer on Rad. Shell. Stainless.	1	1928-31	4.95 ea.
 A-8250-AR	A-8250-AR Cylinder Head Water Neck. USA. 5-3/8" tall.	1	1928-29	21.95 ea.
 A-8250-B	A-8250-B Cylinder Head Water Neck. 6" tall.	1	1930-31	21.95 ea.
 A-8255-A	A-8255-A Cylinder Head Water Outlet Gasket.	1	1928-31	.50 ea.
 A-8255-C	A-8255-C Cylinder Head Water Outlet Copper Gasket. Original gasket between the head & water outlet neck. Show quality.	1	1928-31	5.25 ea.
 A-8260/86	A-8260/86 Radiator Hose Set. Red.	1	1928-31	22.95 set
 A-8260/86-B	A-8260/86-B Radiator Hose Set. Black w/ red stripe.	1	1928-31	14.95 set
 A-8260/86-AR	A-8260/86-AR Red Radiator Hose Set. (set of 3)	1	1928-29	18.95 set
 A-8261-S	A-8261-S Radiator Hose Clamp Set. (6 pcs.)	1	1909-31	6.95 set
 A-8273	A-8273 Temperature Probe Pipe. Unit mounts in upper hose and ends of pipe are rolled to provide snug fit of hose. Correct clamps included. Black powder coated.	1	1928-31	24.00 ea.
 A-8276	A-8276 Mounting Bolt Set for the Water Inlet on Side of Engine. 4 cyl.	1	1928-34	2.95 set

All prices listed in catalog subject to change. Call for current prices.

Part #	Description	Reqd.	Years	Price
<b>Radiator</b>				
A-8280	Gasket for Water Inlet on Side of Eng. 4 cyl.	1	1928-34	.50 ea.
A-8280-C	Water Inlet Copper Gasket. Original gasket between the left side of the engine and the water inlet.	1	1928-31	2.95 ea.
A-8290-AR	Water Pipe for Early A. Designed for larger diameter Powerhouse generator. Petcock fitting installed.	1	1928-29	12.95 ea.
A-8290-ARSS	Early 1928 SS Water Pipe. This pipe is Mandrill Bent as original. Used with the Powerhouse generator.	1	early 1928	18.95 ea.
A-8291	Water Outlet Pipe. USA. Authentic threaded fittings for petcock. (Petcock not included) Black powder coated.	1	1928-31	15.95 ea.
A-8291-SS	Stainless Steel Water Outlet Pipe. Mandrel bent pipe. Petcock fitting 2-1/2" from end. Blueprint copy.	1	1928-31	22.50 ea.
<b>Water Pump &amp; Fan</b>				
A-8501	Water Pump. Complete w/ housing, shaft & all internal parts. Made in USA.	1	1928-31	110.00 ea.
A-8501-K	Water Pump Rebuild Kit with Impeller on Steel Shaft.	1	1928-31	49.95 kit
A-8501-KSS	Water Pump Rebuild Kit with Impeller on Stainless Steel Shaft.	1	1928-31	54.95 kit
A-8501-LP	Water Pump. Leakless type. Sealed front bearing never needs grease. Impeller pinned to stainless shaft. Rear bronze bushing has a lipped seal. No end play. Leakless brass pack nut. Painted with grease fittings. USA.	1	1928-29	149.95 ea.
A-8501-LPZ	Water Pump. Leakless type. Sealed front bearing never needs grease. Impeller pinned to stainless shaft. Rear bronze bushing has a lipped seal. No end play. Leakless brass pack nut. Painted with grease fittings. USA.	1	1930-31	149.95 ea.
A-8502	Water Pump Mounting Stud & Nut Set. 12 pcs.	1	1928-31	3.50 set
A-8502-MB	Water Pump Mounting Bolts.	1	1928-31	5.95 set
A-8503	Water Pump Mounting Nut & Lock Washer Set. (8 pc. set)	1	1928-31	1.95 set
A-8505	Water Pump Cover. Double snap style. Choose black or green.	1	1928-31	7.50 ea.
A-8506	Water Pump Grease Zerk w/ Cover. Brass. 4 cyl.	1	1928-34	2.25 ea.
A-8507	Water Pump to Cylinder Head Gasket.	1	1928-31	.50 ea.
A-8510-S	Stainless Steel Water Pump Shaft. Standard length, less impeller.	1	1928-31	19.95 ea.
A-8511	Water Pump Thrust Collar & Washer Assy. Fits between front of housing & fan hub. Controls fan end play.	1	1928-31	3.25 set
A-8511-K	Fan Shaft Mounting Key, Castle Nut & Cotter Pin. 4 cyl. (3 pcs.)	1	1928-34	1.00 set
A-8512	Water Pump Impeller. (Press on 8-9/16" from fan end. It is best to pin impeller to shaft. Use 3/16" drill & cross drill impeller & shaft).	1	1928-29	6.95 ea.



A-8280



A-8291



A-8501

LP/LP2

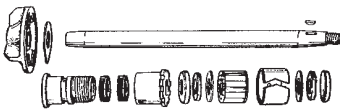

A-8501-K



A-8505



A-8506



A-8511

# Model A Parts

All prices listed in catalog subject to change. Call for current prices.

Part #	Description	Reqd.	Years	Price
<b>Water Pump &amp; Fan</b>				
A-8513	Water Pump Tear Drop Impeller Thrust Washer. Stainless Steel.	1	1928-35	1.25 ea.
A-8513-SS	<b>NEW</b> Water Pump Tear Drop Thrust Washer S.S.			1.50 ea.
A-8520-LB	Water Pump Leakless Rear Bushing. With 2 seals to be leakproof only when new shaft is used. Bronze. 4 cyl.	1	1928-34	29.95 ea.
A-8523	Brass Water Pump Pack Nut with Modern Seal Installed. Correct for 1928-29 but fits all years 1928-34. ( Leakless only with new shaft.)	1	1928-34	17.95 ea.
A-8523-STD	Water Pump Nut, Brass. (Correct for 1928-29 but will fit 1928-31, 4 cy.)	1	1928-29	9.95 ea.
A-8523-W	Water Pump Wrench. Used to tighten packing nut to housing. Die stamped. 4 cyl.	1	1928-34	1.95 ea.
A-8523-WS	Ford Script with P Wrench. USA.	1	1928-34	2.25 ea.
A-8523-Z	Leakless Aluminum Water Pump Nut with Modern Seal Installed. Correct for 1930-31 but fits all years 1928-34 4 cyl. ( Leakless only with new shaft.)	1	1928-34	16.95 set
A-8524	Water Pump Packing. Graphite rings. (3 pcs.)	1	1928-34	3.95 set
A-8524-T	Water Pump Packing. Teflon rope. Fits all water pump shafts. 4 cyl. (To install: cut in single rings & stagger joints)	1	1910-34	2.95 ea.
A-8530	Water Pump Roller Bearing and Sleeve. 4 cyl.	1	1928-34	4.95 set
A-8540	Water Pump Felt, Cup, & Washer Set. Holds felt at either end of bearing. (6 pcs.)	1	1928-34	1.95 set
A-8542	Water Pump Bearing Felt Washer. Acts as grease retainer. Part of A-8540. 4 cyl.	2	1928-34	.50 ea.
A-8575	Thermostat. Fits in upper hose for proper cooling. Non-rusting stainless steel. 4 cyl.	1	1928-34	12.95 ea.
A-8600	Two Blade Fan Assembly. Die cast, tempered alloy. Looks like genuine fan. 4 cyl. USA.	1	1928-34	56.95 ea.
A-8600-4B	Four Blade Fan Assembly. Steel reinforced rib non-original fan for added cooling action. 4 cyl.	1	1928-34	65.00 ea.
A-8620	Fan Belt. V style for authentic look. 4 cyl. USA.	1	1928-34	12.95 ea.
<b>Cowl &amp; Fuel Tank</b>				
A-9000	Fuel Tank Welt. 10' length. 1-1/2" wide X 1/8" bead. (This welt also used at rear of A-16050/51 nose pieces)	1	1928-31	3.95 ea.
A-9008-AR	Gas Tank Clamp w/Hardware. Clamps hold bottom of tank to lower firewall. Takes 5 per side.	10	1928-29	2.75 ea.
A-9009	Gas Tank to Firewall Bolts. (24 pc. set)	1	1928-29	3.50 set
A-9010	Gas Tank Screw Set with Star Washers.(20 pcs).	1	1930-31	2.95 set
A-9010-B	Gas Tank Clamp w/Hardware. Clamps hold bottom of tank in place. Takes 2 per side.	4	1930-31	2.95 ea.
A-9020	Gas Tank Filler Screen & Spark Arrestor. For non-threaded tank. Stainless steel.	1	1928-31	10.95 ea.
A-9030-AR	Gas Cap. Threaded type. Chrome plated brass.	1	1928-29	19.95 ea.
A-9030-C	Gas Cap. Stainless steel.	1	1930-31	18.95 ea.



A-8523-STD

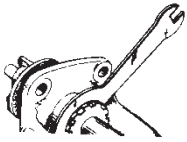

A-8523-W



A-8523-WS



A-8530

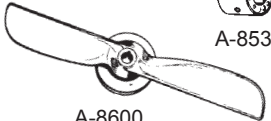

A-8600



A-8600-4B



A-8620



A-9000



A-9020



A-9030-AR



A-9030-C

Part #	Description	Reqd.	Years	Price
<b>Cowl &amp; Fuel Tank</b>				
A-9030-GB	Gas Bib. Lays across cowl to protect paint while refueling.	1	1928-31	16.95 ea.
A-9035-AR	Gas Cap Gasket. Die cut leather.	1	1928-29	.75 ea.
A-9035-B	Gas Cap Gasket. Die cut leather.	1	1930-31	.75 ea.
A-9066-R	Cowl Tank Grommet. Special grommet supports A-17260-A as cable housing enters tunnel up to speedometer.	1	1928-30	2.95 ea.
A-9155-B	Fuel Filter. Die cast body w/ glass bowl. Fits under hood on firewall.	1	1928-31	26.95 ea.
A-9155-RK	Fuel Filter Repair Kit. With tubular screen & gaskets for cast iron filters.	1	1928-31	3.95 kit
A-9156	Corrugated Fiber Filter for Glass Sediment Bowl. Fits inside the glass sediment bowl.	1	1928-31	11.95 ea.
A-9158	Sediment Bowl Glass <i>Only</i> .	1	1928-31	5.95 ea.
A-9160-S	Gas Strainer Gasket & Screen Set. Brass screen & neoprene gasket fits glass bowl sediment bulb.	1	1928-31	1.50 set
A-9161	Late Zenith Side Bowl Filter.	1	1931	49.95 ea.
A-9171	Grommet for Late 1931 Shut-off Valve. Used on indented firewall.	1	1931	2.95 ea.
A-9189-A	Fuel Shut-off Valve. Under tank. Brass. Leakless. USA. Fits 1928 thru mid 1931. (Also Commercial & Truck 1932-47)	1	1928-31	29.95 ea.
A-9189-B	Fuel Shut-off Valve. Brass. Leakless. Fits indented firewall vehicles only.	1	Late '31	36.95 ea.
A-9190/6V	Electric Fuel Shut-off Valve. Electro flow system stops dangerous & smelly gas line leaks. Splice into 1/4" line from firewall to carburetor. Shuts off fuel flow. Instructions included. USA. Top quality. 6 volt.		1928-31	74.95 ea.
A-9191/12V	Electric Fuel Shut-off Valve. Electro flow system stops dangerous & smelly gas line leaks. Splice into 1/4" line from firewall to carburetor. Shuts off fuel flow. Instructions included. USA. Top quality. 12 volt.		1928-31	74.95 ea.
A-9192-A	Fuel Valve Stem. Used April '29 thru May '31. This is a solution to all of the original gas shutoff valves that leak due to years of usage.	1	1929-31	8.95 ea.
A-9193-S	Shut-off Valve Repair Kit. Fits brass valve.	1	1928-31	3.50 kit
A-9193-T	Gas Tank Filter. Fits in shut-off valve A-9189-A & B.	1	1928-31	4.95 ea.
A-9195-B	Fuel Shut-off Valve Packing Nut. The brass nut that holds the packing in place. This should be used when replacing A-9192-A.	1	1929-31	2.25 ea.
A-9230-A	Gasline with Fittings - Tank to Firewall. Seamless steel.	1	1928-29	11.95 ea.
A-9230-B	Gasline with Fittings - Tank to Firewall. Seamless steel.	1	1930-31	11.95 ea.
A-9240-B	Gasline to Carburetor with Fittings.	1	1928-31	16.95 ea.
A-9240-C	Gasline with Fittings. Seamless steel. Used with indented firewall.	1	Late '31	6.95 ea.

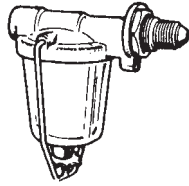

A-9155-B

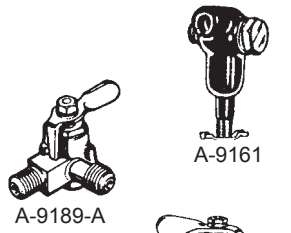

A-9189-A

A-9161

A-9189-B



A-9191/12V



A-9192-A



A-9195-B



A-9230-A

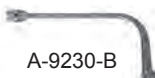

A-9230-B

All prices listed in catalog subject to change. Call for current prices.

# Model A Parts

All prices listed in catalog subject to change. Call for current prices.



A-9300-HD



A-9300-S



A-9320-S



A-9321/23



A-9312-D



A-9326



A-9312-PF



A-9313-C



A-9326



A-9330



A-9425



A-9430



A-9440



A-9433

Part #	Description	Reqd.	Years	Price
<b>Cowl &amp; Fuel Tank</b>				
A-9299-A	Gas Tank Anti-squeak. Woven canvas-like material. Fits between tank & body wherever A-9000 is NOT used.	1	1928-29	2.25 ea.
A-9299-AS	Gas Tank Anti-squeak. Woven canvas-like material. Fits between tank & body wherever A-9000 is NOT used. Fordor Sedans Only.	1	1928-29	2.25 ea.
A-9299-B	Gas Tank Anti-squeak. Woven canvas-like material. Fits between tank & body wherever A-9000 is NOT used. Fordor Sedans.	1	1930-31	2.25 ea.
<b>Fuel Gauge</b>				
A-9300-HD	Gas Gauge Tool Set. Heavy duty.	1	1928-31	13.95 ea.
A-9300-S	Gas Gauge Tool Set. Removes inner & outer nuts.	1	1928-31	6.95 set
A-9312-D	Deluxe Gas Gauge Assembly. (8 pc. set) Includes both inner & outer chromed nuts, lens, black dial, float & neoprene gaskets.	1	1928-31	39.95 set
A-9312-F	Cork Float for Gas Gauge.	1		2.95 ea.
A-9312-PF	Gas Gauge Float, Plastic. No modifications required for installation.	1	1928-31	5.95 ea.
A-9313-C	Gas Gauge Brass Float. Impervious to modern fuel. This float should be trouble free.	1	1928-31	13.95 ea.
A-9320-S	Deluxe Gas Gauge Rebuilding Kit with Gaskets, Lens & New Plastic Float.	1	1928-31	8.95 kit
A-9321/23	Gas Gauge Gasket Set. Economy set. No float or lens.	1	1928-31	1.95 set
A-9325	Gas Gauge Face Plate.	1	1928-31	6.95 ea.
A-9326	Gas Gauge Nut. Small Inner. Chromed.	1	1928-31	7.95 ea.
A-9330	Gas Gauge Nut. Large Outer. Chromed.	1	1928-31	6.95 ea.
A-9331	Gas Gauge Slip Washer. This is the large brass slip washer used when A-9330 is installed in the tank.	1	1928-31	.95 ea.
<b>Manifold</b>				
A-9425	Intake Manifold. Cast Iron. All are drilled and plugged for vacuum wiper. USA.	1	1928-31	99.95 ea.
A-9426	Intake Manifold Mounting Bolts and Lockwasher Set. Raven finish. (4 pc. set).	1	1928-31	1.00 set
A-9430	Exhaust Manifold. USA. Exact duplicate.	1	1928-31	99.50 ea.
A-9433	Exhaust/Intake Manifold Gasket Set. Metal faced 1piece gasket w/ gland rings. 4 cyl. (metal side out).	1	1928-34	7.95 set
A-9433-BC	Manifold Copper Gaskets.	1	1930-34	13.95 pr.
A-9433-C	Manifold Copper Gaskets.	1	1928-30	13.95 pr.
A-9438	Manifold Mounting Stud Set. Hardened. (4 pcs.)	1	1928-34	4.95 set
A-9439	Manifold Washer & Nut Set. Plated. (8 pcs.)	1	1928-34	4.50 set
A-9440	Gland Ring Set for Manifold. (Set of 4) Fits exhaust ports on block for a leak free fit at manifold. 4 cyl.	1	1928-34	2.25 set
A-9443	Heavy Manifold Stud Washer Set. Extra thick stud washers. Spreads tension on castings when drawing nut snug. 4 cyl. (4 pcs.)	1	1928-34	3.95 set

Part #	Description	Reqd.	Years	Price
--------	-------------	-------	-------	-------

## Carburetor

**Please Note** We must have your rebuildable carburetor before shipment will be made. The core must be the same as the carburetor you are ordering. We are unable to extend a core charge.

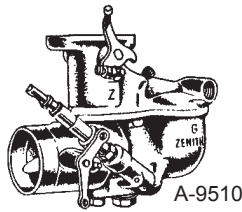

A-9510



A-9510-NT



A-9550



A-9559

A-9447	Carburetor Mounting Gasket at Intake Manifold. Use on Model A only.	1	1928-31	.50 ea.
A-9447-C	Copper Carburetor Mounting Gasket.	1	1928-31	4.95 ea.
A-9502	Carburetor Gasket Set. Zenith A.	1	1928-31	1.95 set
A-9502-TL	Carburetor Gasket Set. Tillotson A. For potmetal carb. Used on Model A only.	1	1928-31	1.95 set
B-9502	Carburetor Gasket Set. B Zenith. 4 cyl.	1	1932-34	1.95 set
A-9510	Zenith Carburetor. USA. Brand new from Zenith blueprints.	1	1928-31	499.95 ea.
A-9510-A	Zenith 1, Air Balanced Carburetor. New air balanced design for improved performance when using an air filter. 100% authentic appearance.		1928-31	550.00 ea.
A-9510-MB	Carb. to Manifold Bolt Set.			.95 ea.
A-9510-NT	Tillotson Carburetor. Brand new production Model X.		1928-34	469.95 ea.
A-9510-TR	<b>NEW</b> Tillotson Carb. Rebuilt. Exchange.			.95 ea.
A-9510-Z	Rebuilt Zenith Carburetor. <b>Exchange Only.</b>		1928-31	225.00 ex.
A-9525	Carburetor Adjusting Needle. Zenith or Tillotson.	1	1928-31	4.95 ea.
A-9528	Choke Adjusting Needle Housing. Brass. Zenith or Tillotson Carb.	1	1928-31	6.95 ea.
A-9532	Adjusting Needle Seat. Brass. Fits Zenith.	1	1928-29	1.95 ea.
A-9534	Main Jet, Zenith Carb.			8.50 ea.
A-9538	Carburetor Cap Jet. Solid brass. Zenith A.	1	1928-31	3.95 ea.
A-9545	Secondary Well. Zenith Carb. 4 cyl.	1	1928-31	3.95 ea.
A-9547	Choke Shaft. Zenith Carb. Standard size.	1	1928-31	5.50 ea.
A-9547-N	Choke Shaft Thick Nut & lock washers. Holds A-9548 lever to end of A-9547 choke shaft. Zenith. Also fits Tillotson A-9547-T shaft.	1	1928-31	.50 ea.
A-9547-T	Choke Shaft. Brass. Tillotson Carb.	1	1928-31	5.95 ea.
A-9548	Choke Shaft Lever. Cadmium plated. Zenith or Tillotson Carb.	1	1928-34	2.50 ea.
A-9549	Carburetor Air Shutter (Choke ) Plate. Zenith A.	1	1928-31	1.95 ea.
A-9549-S	Zenith Choke & Throttle Plate Screw Set. Stainless. (4 pcs.) Fine thread, oval. USA.	1	1928-31	1.00 set
A-9550	Zenith Carburetor Float. Brass. 4 cyl. Ballasted & pressure tested. USA made.	1	1928-31	29.95 ea.
B-9550	Carburetor Float. Brass. Zenith B. 4 cyl.	1	1932-34	14.95 ea.
A-9550-T	Tillotson Carb. Float for Model X & XF.	1	1928-31	44.95 ea.
A-9558	Carburetor Float Pin. Zenith only. Machined brass for accurate fit.	1	1928-31	.35 ea.
A-9559-B	Zenith Carb. Strainer w/ Brass Fittings.	1	1928-31	7.95 ea.
A-9559-C	Zenith Carb. Strainer w/ Cadmium Plated Fittings.	1	1928-31	7.50 ea.
A-9564	Float Valve, Zenith original design Brass.			6.00 ea.
A-9564-A	Zenith A Float Valve w/ Viton Seal.	1	1928-31	18.95 ea.

All prices listed in catalog subject to change. Call for current prices.

# Model A Parts

atalog subject to change. Call for current prices.

All

Part #	Description	Reqd.	Years	Price
<b>Carburetor</b>				
A-9564-C	Zenith 'A' Viton Tipped Needle/Seat. Provides improved fuel shut-off. <i>Model A Zenith only.</i> USA	1	1928-31	19.95 ea.
A-9564-CA	<b>New</b> Zenith Needle Valve with Shims.			17.95 ea.
A-9564-GJT	<b>New</b> Tillotson Ball Type Float Valve.			17.95 ea.
A-9570-C	Adjusting Needle Driver. Cadmium plated. Zenith or Tillotson Carburetors.	1	1928-31	8.50 ea.
A-9575	Compensator Jet, Zenith Carb.			3.25 ea.
A-9576	Zenith Passage Plug Kit. Includes all 3 sizes.	1	1928-31	2.95 ea.
A-9577-A	Idle Adjusting Needle Cap & Spring Set. Brass. This is larger 3/8" head. Zenith.	1	28-mid '30	2.95 set
A-9577-B	Idle Adjusting Needle Cap & Spring Set. Brass. This is larger 5/16" head. Zenith.	1	mid 30-1931	2.95 set
A-9577-C	Idle Adjusting Needle Cap & Spring Set. Cadmium plated. Uses 5/16" head.	1	1930-31	2.95 set
A-9578/9-B	Idle Needle Spring & Brass Cap. Zenith carburetor. (2 pcs.)	1	1928-30	1.00 set
A-9578/9-C	Idle Needle Spring & Cadmium Cap. Zenith carburetor. (2 pcs.)	1	1930-31	1.00 set
A-9581-A	Throttle Shaft & Lever Assembly. Zenith.	1	1928-31	14.95 ea.
A-9581-B	Throttle Shaft & Lever Assembly. .015" oversize for Zenith 'A' carburetor.	1	1928-31	23.95 ea.
A-9581-T	Throttle Shaft & Lever Assembly. Tillotson.	1	1928-31	19.95 ea.
A-9583	Throttle Shaft Bushings. Fits each side of carburetor neck. With instructions.	1	1928-31	1.95 pr.
A-9585	Carburetor Throttle Plate. Brass.			6.95 ea.
A-9586	Venturi. Cast zinc. Zenith carburetor.	1	1928-31	4.95 ea.
A-9590	Zenith Carburetor Rebuild Kit w/Instruction. (20 pcs.)			60.00 kit
A-9590-C	Carburetor Lower Drain Plug. Cadmium plated.		1930-31	1.50 ea.
A-9590-T	Tillotson Carburetor Rebuild Kit w/Instructions. (14 pcs.)	1	1928-31	49.95 kit
A-9599	<b>New</b> Fuel Level Gauge with Instructions.			6.50 ea.
<b>Choke, Spark &amp; Throttle Controls</b>				
A-9600	Air Maze Cleaner. Fits Model A Zenith & Tillotson Carburetors.	1	1928-31	22.95 ea.
A-9600-F	Paper Filter for Air Maze. This special paper element filter cleans the dust out that causes engine wear. Double screened fits in place of wire mesh for clean air flow.	1	1928-31	10.95 ea.
A-9600-M	Metal Filter for the Air Maze.	1	1928-31	5.95 ea.
A-9610	<b>New</b> Choke Shaft Tillotson. Does not work in Cast Iron Tillotson.			6.95 ea.
A-9611	<b>New</b> Choke Plate Tillotson. Brass, USA. Does not work in Cast Iron Tillotson.			3.95 ea.
A-9629	<b>New</b> Throttle Shaft/Lever Tillotson. USA. Does not work in Cast Iron Tillotson.			19.95 ea.
A-9631	<b>New</b> Throttle Plate Tillotson. Does not work in Cast Iron Tillotson.			3.95 ea.
A-9700-B	Choke Rod Assembly. With sleeve, spring & knob. 26" long.	1	1928-29	9.95 ea.



A-9581-B



A-9586



A-9590



A-9590-T

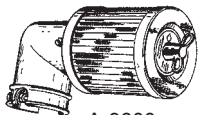

A-9600

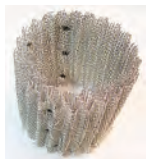

A-9600-M



A-9700



All prices listed in catalog subject to change. Call for current prices.

## Part # Description Req'd. Years Price

### Choke, Spark & Throttle Controls

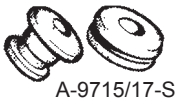

A-9715/17-S



A-9735-F



A-9737-B



A-9765/70-S



A-9742-S



A-10000-A6



A-10000-A6



A-10020-B



A-10130-B



A-10094

A-9700-C	Choke Rod Assembly. With sleeve, spring & knob. 28-1/2" long.	1	1930-31	10.95 ea.
A-9705	Choke Rod Sleeve. Steel.	1	1928-31	1.25 ea.
A-9709	Choke Rod Spring. Original black finish.	1	1928-31	.50 ea.
A-9715/17-S	Choke Rod Grommet Set. Fits tank & firewall.	1	1928-31	1.50 set
A-9725	Accelerator Cap. Screws on to acc. assy.	1	1928-31	3.95 ea.
A-9735-F	Fulton Accessory Accelerator Pedal. Includes mounting screws.	1	1928-31	26.50 ea.
A-9737	Accelerator Spring. The straight cylindrical style. Used 1928 thru late 1929.	1		2.95 ea.
A-9737-B	Accelerator Spring, Plated. Tapered cylindrical shape. Late 1929 & on.			2.25 ea.
A-9742-S	Control Rod Set - Spark, Throttle, Accelerator. Cadmium plated. (3 pc. set)	1	1928-31	22.95 set
A-9765/70-S	Accelerator Foot Rest w/ Base.	1	1928-34	10.95 set

## Generator

**Please Note** Rebuilt Generators require a re-buildable core. We cannot process your order until the core is received. Gaslight is unable to extend a Core Charge.

A-10000	Generator. Rebuilt. <b>Sold Exchange Only. Less pulley.</b> A complete rebuilt generator with all new or refurbished parts. New field coils, bearings, brushes and post kit installed. The armature is turned, polished, ground tested and then growl tested for shorts. 4 cyl.	1	1928-34	210.00 ex.
A-10000-A6	Alternator, 6 volt. Positive Ground. Great dependability & a must have when running up-graded lighting or accessories. 45 amp. (5 year guarantee against defects.)	1	1928-31	179.95 ea.
A-10000-A12	Alternator, 12 volt. Negative Ground. Same as 6 volt only 95 amp.	1	1928-31	179.95 ea.
A-10001	<b>New</b> Alternator Bracket. Bracket fits Alternator we stock.			37.50 ea.
A-10020-B	Generator Rebuilding Kit. Totally complete. (Over 75 pcs.)	1	1929-31	53.95 kit
A-10057	<b>New</b> Generator Brush Spring. Third Brush and Ground Brush.			2.75 ea.
A-10069	Generator Brush Set. (3 pcs.) Not for Powerhouse type.	1	1929-39	2.95 set
A-10094	Generator Front Bearing. Double shielded.	1	1929-48	3.50 ea.
A-10096	<b>New</b> Generator Front End Plate Rivet Set.			1.50 ea.
A-10099	<b>New</b> Generator Bearing Retaining Clip.			2.75 ea.
A-10103	<b>New</b> Generator Post Kit.			4.95 ea.
A-10128	Bushing. Fits generator end plate. Not for early powerhouse style units.	1	4/30 -31	1.00 ea.
A-10130-B	Generator Pulley. Machined cast iron. Fits long & short taper shafts.	1	1928-31	23.95 ea.
A-10132	Generator Pulley Cap Screw & Washer Set. Fits 7/8" tapered pulley. 1/4"-28.	1	1928-4/30	.95 set
A-10140-C	Generator Cover Band. With built-in air scoop for added cooling. Regular generator only.	1	1928-39	16.95 ea.

# Model A Parts

All prices listed in catalog subject to change. Call for current prices.

**Part # Description Req'd. Years Price**

## Generator

**Please Note** Rebuilt Generators require a re-buildable core. We cannot process your order until the core is received. Gaslight is unable to extend a Core Charge.

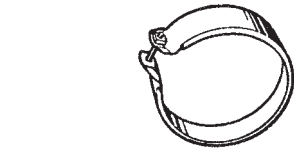

A-10142

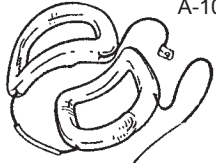

A-10175-C

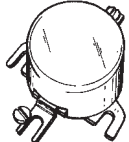

A-10505



A-10505-SF



A-10606

A-10850-A



A-11002-C



A-11025-BS



A-11054-S



A-11080

A-10142	Generator Cover Band with Hardware. Die formed steel. Regular generator only.	1	1928-39	2.95 ea.
A-10143	Generator Pulley Cap Screw & Washer Set.	1	4/30 -32	1.00 set
A-10144-R	Generator Pulley Adapter. Allows you to use a short nose pulley on a long nose generator. USA.	1	1928-31	1.95 ea.
A-10152	Generator Mounting Bolt Set.	1	1929-34	1.95 set
.10156	Generator Tension Bracket. Bolts to timing gear cover to eliminate movement & keep belt tight.	1	1929-34	4.95 ea.
.10175-C	Field Coils for Generator.	1	1928-34	52.95 set
A-10505	Generator Cutout Positive ground. Fits on top of generator. Quality foreign product. (Note: Clip goes on side closest to mounting ears)	1	1928-31	49.95 ea.
A-10505-F	Diode Version Script Cutout. 6 volt. 5 amp rated. (Note: Clip goes on side closest to the mounting ears. This is the arm side.)	1	1919-39	49.95 ea.
A-10505-GCS	Generator Cutout Mounting Screw Set. Raven finish. (4 pc. set)	1	1929-39	.75 set
A-10505-R	Voltage Regulator. Positive ground. Looks same as cutout. (Not for V-8's or Model T's).	1	1928-31	89.95 ea.
A-10505-SC	Semi-conductor Cutout. Delivers full 20 amp continuous service. Positive ground system only.	1	1928-31	56.50 ea.
A-10505-SF	Diode Fuse Kit. Fits A-10505 & A-10505-F. Positive ground. Prevents overload & short circuit.	1	1928-29	3.95 kit
A-10606	Voltage Drop Resistor. Used when converting to 12 volt system & retaining original 6 volt style accessories.	1	1919-54	14.50 ea.
A-10850-A	Ammeter 20-20.	1	1919-31	7.95 ea.
A-10850-B	Ammeter 30-30. Non-Script.	1	1919-31	12.95 ea.
A-10850-BF	Ammeter 30-30. Ford Script.	1	1919-31	12.95 ea.
A-10850-F	Ammeter 20-20. Ford script.	1	1919-31	9.95 ea.
A-10850-N	Ammeter Nut Set. (1 pr.)	1	1919-31	1.50 set

## Starter

**Please Note** Rebuilt Starters require a rebuildable core. We cannot process your order until the core is received. Gaslight cannot extend a Core Charge.

A-11002-C	Starter Motor. Rebuilt. <b>Sold Exchange Only.</b> A complete rebuilt starter with all or refurbished parts. New field coils, bushings, brushes installed. Armature turned, polished, ground tested and then growl tested for shorts. Painted.	1	1928-31	225.00 ex.
A-11025-BS	Starter Motor Rebuilding Kit. 60 piece kit for complete job. Not for ball bearing starters.	1	1928-31	67.95 kit
A-11054-S	Starter Brush Set. Set of 4.	1	1929-33	4.95 set
A-11080	Starter Field Coil Set, 6 Volt.	1	1928-32	56.95 set
A-11102-C	Bronze Starter Field Contact.	1	1928-31	4.95 ea.

Part #	Description	Reqd.	Years	Price
<b>Starter</b>				
A-11102-CS	<b>New</b> Starter Contact Button and Terminal Insulator Set.			16.95 ea.
A-11125	Starter Motor Cover Band w/ Mounting Hardware. Die formed steel.	1	1928-32	2.95 ea.
A-11130-SH	Starter Shim Paper Gasket.	1	1928-31	.50 ea.
A-11135-A	Starter Drive End Plate Bushing. Fits early starters only. 688 O.D.		1928-29	2.75 ea.
A-11136	Starter End Plate Bushing. The rear bushing used in the brush end plate. Thin wall.	1	Early '28	1.25 ea.
A-11136-B	Starter End Plate Bushing. The rear bushing used in the brush end plate. Thick wall.	1	Mid'28-48	1.25 ea.
A-11350	Starter Bendix Drive Assy. with Spring.	1	Mid'28-50	36.75 ea.
A-11350-M	Modern Style Bendix Drive. More reliable & works great with 6 or 12 volts.	1	1928-53	23.00 ea.
A-11350-T	Modern Bendix Drive Installation Tool. A helpful tool when installing the modern Bendix drive.	1	1928-31	19.95 ea.
A-11375-C	Starter Drive Spring. 3/8" bolt eyelets.	1	1928-53	7.95 ea.
A-11378-S	Starter Drive Screw & Washer Set (3/8").	1	1928-50	2.95 set
A-11380	Starter Drive Shaft Key. Case hardened steel.	1	1928-50	.25 ea.
A-11450-C	Starter Switch w/ Copper Contact. Cadmium plated. USA.	1	1928-31	24.95 ea.
A-11451	Starter Switch Mounting Screws & Washers. (8 pc. set)	1	1928-31	1.00 set
A-11452	Starter Switch Gasket & Insulator. Oil & water resistant material.	1	1928- mid '30	1.00 set
A-11460	Safety Fuse Block. USA. Mounts on starter. Protects vehicle wiring system. . 4 cyl. Now includes longer screws for mounting and 2 fuses.	1	1928-31	18.95 ea.
A-11460-F	Replacement Fuses for A-11460. (Pkg. of 5) 30 amp. fuses.	1	1928-31	2.95 pkg
A-11470	Starter Push Rod. Plated. Screws into starter switch.	1	1928-34	1.95 ea.
A-11471-P	Starter rod Cover. Rubber pad for starter rod. Non original.	1	1928-31	1.25 ea.
A-11480-S	Starter Push Rod Grommet & Cover. Oval style.	1	1928-30	2.50 set
A-11481-S	Starter Push Rod Grommet & Cover. Round style. Used Sept. 1930 thru 1931.	1	1930-31	2.50 set
<b>Instrument Panel</b>				
A-11556	On-off Switch Plate.	1	1928-31	1.95 ea.
A-11556-A	Key Fob with Ford Logo & Specific Year. USA.		1928	6.00 ea.
A-11556-B	Key Fob with Ford Logo & Specific Year. USA.		1929	6.00 ea.
A-11556-C	Key Fob with Ford Logo & Specific Year. USA.		1930	6.00 ea.
A-11556-D	Key Fob with Ford Logo & Specific Year. USA.		1931	6.00 ea.
A-11557-A	Outer Ring for Ignition Switch Plate. Stainless steel.	1	1928-31	6.00 ea.
A-11575-ER	Ignition Switch Assembly. Replacement type. Authentic appearance under the hood but uses the replacement switch in the dash.	1	1928-31	29.95 ea.



A-11350



A-11350-M



A-11450-C

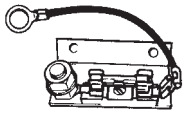

A-11460



A-11460F



A-11480-S



A-11481-S



A-11556



A-11557-A

All prices listed in catalog subject to change. Call for current prices.

# Model A Parts

All prices listed in catalog subject to change. Call for current prices.

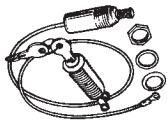

A-11575-F



A-11575-SW



A-11654

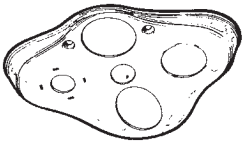

A-11805-AR

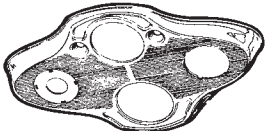

A-11805-E

A-12115 A-12275

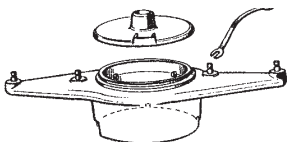

A-12105

A-12275

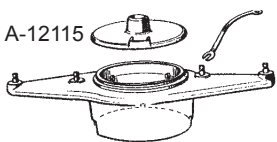

A-12105



A-12106

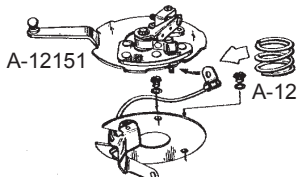

A-12151

A-12148



A-12152

Part #	Description	Reqd.	Years	Price
<b>Instrument Panel</b>				
A-11575-F	Ignition Switch. Small cable. Replacement style. A-14560-G used to prevent short outs.	1	1928-31	23.95 ea.
A-11575-SW	Switch and Keys Only. Replacement style.	1	1928-31	10.95 ea.
A-11654	Headlight Switch Assembly. Cadmium plated. Fits at bottom of steering column.	1	1928-37	16.95 ea.
A-11654-US	<b>New</b> Light Switch. USA. Made to Exact Original Prints.			42.95 ea.
A-11805-AR	Instrument Panel w/ Screws. Chromed. For Oval Speedometer.	1	'28-5/30	52.95 ea.
A-11805-E	Instrument Panel w/ Screws. Chromed. For Round Speedometer.	1	4/30-'31	52.95 ea.
<b>Ignition</b>				
A-12000-P	Ignition Coil with Bracket, 6 volt. 4 cyl.	1	1928-34	19.95 ea.
A-12000-B	<b>New</b> Coil Bracket Only.			2.95 ea.
A-12002	Coil Bracket Mounting Screw Set. 4 cyl. (4 pcs.)	1	1928-34	1.00 set
A-12100	Distributor Assembly with Precision Cam. Made in USA. Exact duplicate.	1	1928-31	169.95 ea.
A-12105	Distributor Body. Black bakelite. 4 cyl.	1	1928-34	34.95 ea.
A-12105-BR	Distributor Body. Brass contacts.			29.95 ea.
A-12105-S	One Piece Distributor Cap Set. Includes wiring & rubber moisture boots. 4 cyl.	1	1928-34	29.95 set
A-12106	Distributor Set Screw & Nut. Screw holds distributor in head.	1	1928-31	1.25 set
A-12115	Distributor Body Cap. USA.. 4 cyl.	1	1928-34	5.50 ea.
A-12127-K	Distributor Hardware Kit. All screws, rivets & insulators required for rebuilding a distributor.	1	1928-31	5.95 kit
A-12132	Distributor Shaft Bushing. Graphited bronze. Used in cast iron base where A-12178-H fits. 4 cyl.	2	1928-34	.75 ea.
A-12135	Distributor Base Oiler. Nickel plated knurled brass. Exact duplicate.	1	1928-34	2.95 ea.
A-12137	Distributor Breaker Plate Spring. Fits on top of lower plate.	1	1928-31	.50 ea.
A-12144	Distributor Cap Clamp & Rivet Set. 4 cyl. (4 pc. set)	1	1928-34	6.50 set
A-12148	Distributor Lower Plate w/ Wire Pigtail.	1	1928-31	12.95 ea.
A-12148-LW	Lower Plate Extended Wire. Longer pigtail wire provides maximum flexibility for A-12151 or A-12152 upper plates.	1	1928-31	3.50 ea.
A-12149	Lower Distributor Plate. An improved wireless lower plate with brass contacts to insure positive contact.	1	1928-31	15.95 ea.
A-12149-K	Wireless Plate Adapter Kit. Used with our A-12149 & A-12152. Kit includes template & instructions.	1	1928-31	1.95 ea.
A-12151	Distributor Upper Plate w/ Insulated Point Pad.	1	1928-31	10.95 ea.
A-12152	Ignition Upper Plate Conversion. Uses modern points & condenser. Requires A-12148-LW to reach modern points.	1	1928-31	34.95 ea.
A-12160	Distributor Point Block. Complete w/ mounting screws. Made in USA.	1	1928-31	5.95 ea.

All prices listed in catalog subject to change. Call for current prices.

Part #	Description	Reqd.	Years	Price
<b>Ignition</b>				
A-12178-H	Distributor Upper Shaft w/ Lube Hole. Precision ground upper shaft & screw drilled for oiling with thrust washer. USA.	1	1928-31	11.95 set
A-12180	Distributor Cam Steel Thrust Washer. Fits under collar of upper shaft in top of distributor. 1/64" thick.	1	1928-31	.25 ea.
A-12194	Distributor Shaft Fiber Washer. Fits between distributor base and top of A-12195. Reduces shaft end play. 1/32" thick.	1	1928-31	.25 ea.
A-12195	Distributor Shaft Sleeve & Pin Set. 4 cyl. Sleeve fits at base of distributor. Pin holds it in place.	1	1928-34	1.25 set
A-12199	Ignition Point Set. (Gap at .018/.022)	1	1928-31	9.95 set
A-12199-M	Ignition Points for A-12152 Conversion.	1	1928-31	6.95 set
A-12199-Q	Ignition Point Set. Higher quality.	1	1928-31	14.95 ea.
A-12200	Rotor for Distributor, 4 cyl. Made in USA.	1	1928-34	6.95 ea.
A-12210	Distributor Cam. Hardened & ground. USA. For Model A but will fit Model B 4 cyl.	1	1928-34	12.95 ea.
A-12210-NR	<b>New</b> Cam Wrench made by Nu-Rex. Makes Timing Model A easy. Directions on wrench.			11.95 ea.
A-12210-W	Distributor Cam Wrench. Quick adjust. Allows cam adjustment without removing distributor body or plug wires. 4 cyl.	1	1928-34	2.95 ea.
A-12211	Distributor Cam Screw & Washer Set. Screw with oil hole drilled and washers. This 2 pc. set holds cam. 4 cyl.	1	1928-32	1.50 set
A-12249	Distributor Lower Shaft in Block. Fits between A-6551 & upper shaft. 4 cyl. USA.	1	1928-34	4.95 ea.
A-12275-A	Spark Plug Connectors. Straight die-stamped bronze. 3-1/8" long. (Set of 4)	1	1928-5/30	2.50 set
A-12275-B	Spark Plug Connectors. Offset die stamped bronze. 3-1/8" long. (Set of 4).	1	6/30-1931	2.50 set
A-12280	Heat Baffle. Fits under distributor. Protects condenser from engine heat. Polished stainless steel. Not for heater manifold.	1	1928-31	11.95 ea.
A-12300	Condenser. Heat proof. Made in USA.	1	1928-31	7.95 ea.
A-12300-F	False Condenser Shell for A-12152. Use this with A-12152 modern upper plate. Maintains original appearance of distributor. USA.	1	1928-31	3.95 ea.
A-12300-M	Condenser. Used with A-12152 conversion.	1	1928-31	9.95 ea.
A-12405-3X	Champion 3X Spark Plug. Brass top. 'The Judging Plug' (Gap .032-.035. 4 cyl.)	4	1928-31	36.95 ea.
A-12405-B	Champion Spark Plug. Provides a moderately hotter spark for the short trips. 7/8".	4	1928-31	12.95 ea.
A-12405-R	Spark Plug. Modern replacement 7/8" thread. This plug runs slightly hotter than A-12405-B. Great plug for the driving car.	4	1928-31	4.95 ea.
A-12405-T	Engine Lift/Head Puller Tool. Used to remove engines & stock heads. Using 2 makes the job easier.		1928-31	11.95 ea.
A-12409	Spark Plug Nuts. Brass nuts for the top of the spark plugs. USA.	1	1928-31	2.25 set
A-12410	Spark Plug Gaskets. Ring style. Fits 7/8" plugs. (Set of 4)	1	1909-34	3.50 set



A-12199-Q



A-12200

A-12210-W

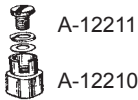

A-12211

A-12210

A-12178-H



A-12275-B



A-12275-A



A-12280



A-12300



A-12405-3X



A-12405-R



A-12300-F



A-12405-B



A-12405-T

# Model A Parts

All prices listed in catalog subject to change. Call for current prices.

Part #	Description	Reqd.	Years	Price
<b>Headlamps</b>				
A-13000	Headlamp Bulb, 50-32 cp. 6 volt. Dbl. contact.	2	1919-34	1.50 ea.
A-13000/12V	Headlamp Bulb, 50-32 cp. 12 volt Double contact. Straight pins.	2	1928-34	1.50 ea.
A-13000-HAL	Hallogen Headlamp Bulb. Uses original style base for easy installation.	1	1919-34	27.00 ea.
A-13000-LED	<b>New</b> Bright White LED Direct Replacement Bulb. Works with 6, or 12 volt. Can be used with generator, or alternator. A must have item.			29.95 ea.
A-13001-A	<b>New</b> LED Fuse Panel Controls all LED Lighting and Turn Signals kits, USB Port for charging cell and laptop. Easy install with no modifications. Instructions included.			79.95 ea.
A-13001-B	<b>New</b> LED Fuse Panel Controls all LED Lighting and Turn Signals kits, USB Port for charging cell and laptop. Easy install with no modifications. Instructions included.			79.95 ea.
A-13001-A	<b>New</b> LED Fuse Panel Controls all LED Lighting and Turn Signals kits, USB Port for charging cell and laptop. Easy install with no modifications. Instructions included.			79.95 ea.
A-13001-USB	<b>New</b> USB Charge Port "Type A". Charge phones, tablets and other accessories. 6, or 12 volt pos., or neg. ground.			89.95 ea.
A-13005-A	Headlamp Assembly. Stainless steel. 1 bulb style. Script fluted lens.	1	1928-29	320.00 pr.
A-13005-AR	Headlamp Assembly. Stainless steel. 2 bulb style. Script fluted lens.	1	1928-29	320.00 pr.
A-13005-F	Headlamp Assembly. Stainless steel. 2 bulb style. Ford script lens.	1	1930-31	320.00 pr.
A-13005-G	Headlamp Assembly. Stainless steel. 1 bulb style. Ford script lens.	1	1930-31	320.00 pr.
A-13007-Q12	Halogen Adapter Kit. Converts standard headlights to Halogen. 12 volt only.	1	All	29.95 kit
A-13010-A	Reflector Inner Steel Ring. Must be welded in the headlight bucket. (2 req'd)	2	1928-29	13.50 ea.
A-13010-B	Reflector Inner Steel Ring. Must be welded in the headlight bucket. (2 req'd)	2	1930-31	13.50 ea.
A-13021-A	Top Rim Clip. Holds rim to headlight shell.	1	1928-29	1.95 ea.
A-13021-B	Top Rim Clip. Holds rim to headlight shell.	1	1930-32	1.50 ea.
A-13025-AS	Headlamp Reflectors. 1 bulb style for all single bulb cars w/ cowl lights. Chrome plated brass.	1	1928-31	64.00 pr.
A-13025-BS	Headlamp Reflectors. 2 bulb style for all double bulb cars without cowl lights. Chrome plated brass.	1	1928-31	59.95 pr.
A-13027-QK12	<b>New</b> Quartz Halogen Kit. Complete with Reflectors, Sockets, Bulbs and Gaskets. 12 Volt.			89.95 ea.
A-13043-A	Headlamp Outer Rim. Stainless steel. (Order 2 if doing one vehicle)	1	1928-29	29.50 ea.
A-13043-B	Headlamp Outer Rim. Stainless steel. (Order 2 if doing one vehicle)	1	1930-31	29.50 ea.
A-13043-S	Headlamp Rim Latch Rebuild Set for 2 Rims. Stainless T bars. (Set of 8)	1	1928-36	5.95 set



A-13000

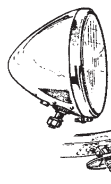

A-13005-AR

A-13043-S



A-13007-Q12



A-13025-AS



A-13025-BS

All prices listed in catalog subject to change. Call for current prices.

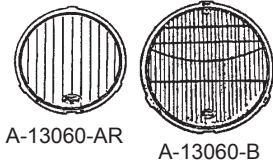

A-13060-AR A-13060-B

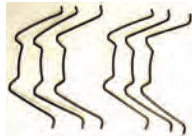

A-13061-BS



A-13065-R

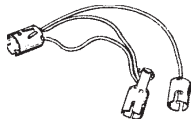

A-13075



A-13078



A-13079



A-13101-AS



A-13114-A

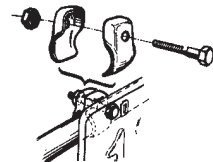

A-13145-S



A-13300-AR



1930-31

A-13300-E

Part #	Description	Reqd.	Years	Price
<b>Headlamps</b>				
A-13047	Headlamp Mounting Rivet Set. Stainless steel rivet head screws & lock nuts. This 36 pc. set does both head lamps.		1928-36	3.50 set
A-13058-A	<b>New</b> Headlight Latch Bracket.			2.00 ea.
A-13058-B	<b>New</b> Rim Latch Clip 1930/31.			2.00 ea.
A-13060-AR	Headlight Lens. Fluted. Ford script. Exact duplicate.	2	1928	23.95 ea.
A-13060-B	Headlight Lens. Twolite. Ford script. Exact duplicate.	2	1929-31	26.95 ea.
A-13061-AS	Headlamp Wire Lens Retainers. (Set of 6)	1	1928-29	2.25 set
A-13061-BS	Headlamp Wire Lens Retainers. (Set of 6)	1	1930-32	1.95 set
A-13065-R	Headlamp Lens Gaskets. Treated cork & neoprene. Car & Truck.	1	1928-37	1.75 pr.
A-13075-AR	Headlight Socket Assembly. 1 bulb AR style.	1	1928	19.95 pr.
A-13075-BR	Headlight Socket Assembly. 2 bulb style.	1	1928-29	19.95 pr.
A-13075-CR	Headlight Socket Assembly. 1 bulb style. Used with cowl lights.	1	1928-29	18.95 pr.
A-13075-FR	Headlight Socket Assembly. 2 bulb style.	1	1930-31	24.95 pr.
A-13075-GR	Headlight Socket Assembly. 1 bulb style. Used with cowl lights.	1	1930-31	18.95 pr.
A-13078	Sleeve. Attaches conduit collar to headlight bucket. Solid brass.	1	1929-32	5.95 ea.
A-13079	Headlight Wiring Socket Holder in Base of Headlamp. Holds wiring in place as it protrudes from bottom of bucket.	1	1929-32	3.95 ea.
A-13101-AS	Headlamp Focusing Spring & Stainless Steel Screw Set. (4 pc. set)	1	1928-29	1.50 set
A-13101-BS	Headlamp Focusing Spring & Stainless Steel Screw Set. (4 pc. set)	1	1930-31	1.50 set
A-13114-A	Headlight Bar Rubber Pads. Fits between fender & bar.	1	1928-29	1.00 pr.
A-13114-B	Headlight Bar Rubber Pads. Fits between fender & bar.	1	1930-31	1.00 pr.
A-13119	Headlamp Bar to Fender Bolt Set. (12 pcs.)	1	1928-31	2.95 set
A-13145-S	Front License Plate Clip Set w/ Bolts & Nuts.	1	1928-31	5.95 set
A-13145-SS	Stainless Steel Front License Plate Clip Set w/Bolts & Nuts.	1	1928-31	9.95 set

## Cowl Lights

Stainless steel lights made to exacting original specifications readily gives the deluxe appearance to any Model A. All parts are made exactly alike and interchangeable with original parts. The arms are chrome plated.



A-13300-AR	Cowl Light Assembly. Stainless steel shells & chrome arms. Exact duplicate.	1	1928-29	159.95 pr.
A-13300-AR/TS	Turn Signal Kit for Cowl Lights. Includes 12 volt bulbs. (Use A-13301 for 6 volt system).	1	1928-29	29.95 ea.
A-13300-ARWS	Cowl Lamp Assembly with Signals Installed. Stainless shells & chrome arms. Exact duplicate.	1	1928-29	172.50 pr.
A-13300-E	Cowl Light Assembly. Stainless steel shell & chrome arms. Exact duplicate.	1	1930-31	139.95 pr.
A-13300-E/TS	Turn Signal Kit for Cowl Lights. Includes 12 volt bulbs. (Use A-13301 for 6 volt system).	1	1930-31	32.95 ea.

# Model A Parts

All prices listed in catalog subject to change. Call for current prices.

**Part # Description Req'd. Years Price**

## Cowl Lights

A-13300-WS	Cowl Lamp Assembly with Signals Installed. Stainless shells & chrome arms. Exact duplicate.	1	1930-31	146.95 pr.
A-13301	Turn Signal Bulb to Fit Above Kits. 6 volt, 21/6 cp. Double contact.	2	1928-31	1.50 ea.
A-13301/12V	Turn Signal Bulb. 12 volt. 21/3 cp. Double contact with offset pins.	2	1928-31	1.50 ea.
A-13302	Turn Signal Switch. Clamps on steering column. 7 wire design w/ flasher warning. Die cast.	1	1928-48	29.95 ea.
 A-13302	A-13302-KIT Turn Signal Kit, Complete. Super bright LED turn signals. This kit can be used on 6V or 12V positive or negative ground. This is a great kit for any vintage auto.		All years	225.00 kit
 A-13304-P	Turn Signal Flasher Socket w/ Wires. Must have part when converting your system.	1	1928-31	2.95 ea.
A-13304-S	Turn Signal Flasher Unit. 6 volt. USA. Heavy duty.	1	1928-34	4.95 ea.
A-13304-T	Turn Signal Flasher Unit. 12 volt. USA. Heavy duty.	1	1928-34	5.50 ea.
A-13308-AR	Cowl Light Lens. Clear glass.	2	1928-29	3.95 ea.
A-13308-D	Cowl Light Lens. Clear glass.	2	1930-31	5.95 ea.
A-13309-AR	Cowl Light Lens Gaskets.	1	1928-29	1.00 pr.
A-13309-C	Cowl Light Lens Gaskets.	1	1930-31	1.00 pr.
A-13315-C	Cowl Lamp Reflector.	1	1930-31	11.95 ea.
A-13316-S	Cowl Light Lens Retainer Clip Set. (6 pcs.)	1	1930-34	1.25 set
A-13318	Cowl Light Mounting Blocks. Fits inside body to prevent strain on cowl panel.	1	1930-31	3.95 pr.



A-13405-L

## Tail Lamps

A-13405-L	Drum Tail Lamp & License Bracket Assembly. Left side. Made in USA. Used through Feb. 1929.	1	1928	119.95 ea.
A-13405-LC	12 Volt LED All Red Lens. Left Side. Everything needed to convert existing tail lamp to LED.	1	1929-31	33.95 ea.
A-13405-LC6V	6 Volt LED Card with Red Lens. Left Side. Everything needed to convert existing tail lamp to LED.	1	1929-31	34.95 ea.
A-13405-LL	12 Volt LED Tail Lamp Assembly solid red lens. Left Side. Polished stainless steel housing.	1	1929-31	54.95 ea.
A-13405-LL6V	6 Volt LED Tail Lamp Assembly solid red lens. Left Side. Polished stainless steel housing.	1	1929-31	69.95 ea.
A-13405-RC	12 Volt LED All Red Lens. Right Side. Everything needed to convert existing tail lamp to LED.	1	1929-31	23.95 ea.
A-13405-RC6V	6 Volt LED Card with Red Lens. Right Side. Everything needed to convert existing tail lamp to LED.	1	1929-31	37.95 ea.
A-13405-RL	12 Volt LED Tail Lamp Assembly with Solid Red Lens. Right Side. Polished stainless steel housing.	1	1929-31	44.95 ea.
A-13405-RL6V	6 Volt LED Tail Lamp Assembly with Solid Red Lens. Right Side. Polished stainless steel housing.	1	1929-31	60.00 ea.



A-13405-LL



A-13405-LL6V



A-13405-RC6V



A-13405-R



A-13405-RL6V



All prices listed in catalog subject to change. Call for current prices.

Part #	Description	Reqd.	Years	Price
<b>Tail Lamps</b>				
A-13405-R	Drum Tail Lamp Assembly. Right side. USA.	1	1928	109.95 ea.
A-13405-SL	Tail Lamp Assembly. Duolamp. Left side. Polished stainless steel. Exact duplicate.	1	1929-31	37.95 ea.
A-13405-SR	Tail Lamp Assembly. Duolamp Right side Polished stainless steel. Exact duplicate.	1	1929-31	37.95 ea.
A-13406-AR	Drum Tail Lamp Bracket. Stamped steel. USA.	1	1928	27.95 ea.
A-13406-B	Rear License Bracket. Die stamped "Duolamp". USA. (Also for 1929-47 Pickups)	1	1929-31	6.95 ea.
A-13408	Internal Plate & Rivets to Rebuild Drum Tail Lamp. (7 pc. set)	1	1928	19.95 set
A-13410-R	Socket Assembly for Drum Type Tail Lamp.	1	1928	43.95 ea.
A-13412	Tail Lamp Wiring in Fabric Loom. Authentic color-coded wiring.	1	1929-32	5.95 ea.
A-13412-DC	Double Contact Socket. Used with A-13301 turn signal bulb.		All years	6.50 ea.
A-13440-AR	Tail Lamp Body. Drum type. Nickel plated. Made in USA.	1	1928	29.95 ea.
A-13442-AR	Stop Face Plate. Fits drum tail lamp. Die stamped steel. Made in USA.	1	1928	7.95 ea.
A-13445-AR	White Lens for Drum Tail Lamp.	1	1928	7.50 ea.
A-13445-B	White Lens for License Light.	1	1929-32	4.95 ea.
A-13446	License Lens Retainer Set w/ Stainless Screws. Holds the clear license plate lens.	1	1929-48	1.00 set
A-13448-A	Tail Lamp Rim. Stainless steel.	1	1929-31	4.95 set
A-13449	Tail Lamp Screw Set. Tail lamp to bracket. Stainless. Includes 2 screws for T/L rim. (6 pcs.)	1	1929-32	1.95 set
A-13450-AR	Red Tail Lamp Lens for Drum Type Lamp.	1	1928	7.95 ea.
A-13450-B	Red Tail Lamp Lens w/Glass Blue Dot Center.	1	1929-31	14.50 ea.
A-13450-F	Red Tail Lamp Lens.	1	1929-31	7.95 ea.
A-13450-G	Red/Amber Tail Lamp Lens. 2 tone glass.	1	1929-31	8.95 ea.
A-13450-S	Red/Amber Lens. "Stop" embossed in the upper amber portion of the lens.	1	1929-31	8.95 ea.
A-13456-B	Snap Ring. Holds tail lamp lens in place.	1	1929-32	.75 ea.
A-13460-AR	Drum Tail Lamp Gasket (2 pc. set)	1	1928	1.00 set
A-13460-B	Tail Lamp Gasket Set. (3 pcs.)	1	1929-31	1.00 set
A-13463	Tail Lamp Bracket Reinforcing Plate. Die formed to fit curved underside of fender.	1	1929-31	3.50 ea.
A-13465	Stop Light Bulb. 6 volt. 21 cp. Single contact w/ straight pins. (Also Fits 1932-42 Commercial)	1	1926-32	1.25 ea.
A-13465/12V	Brighter Stop/Brake Light Bulb. 12 volt, 21 cp. Yields higher visibility when used in a 12 volt system.	1	1929-42	1.25 ea.
A-13465-HAL	Halogen Stop Light Bulb. Uses original style base for easy installation.		1919-31	17.00 ea.
A-13465-HP	Brighter Stop/Brake Light Bulb. 6 volt. 30 cp. This higher candlepower offers better visibility & safety. Ensures other drivers will see you when using brakes.		1926-42	1.25 ea.
A-13466	Light Bulb for Dome, Park, Tail Light, Dash Lamp & Cowl Lamp. 3 cp. 6 volt.		1919-36	1.25 ea.
A-13466/12V	Light Bulb for Cowl & Taillights as well as Dash, Dome & Parking Lights. 12 volt. 4 cp. Single contact.	1	1929-42	1.25 ea.

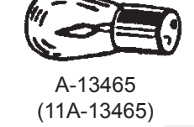
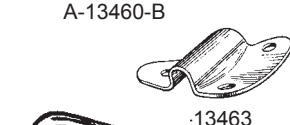
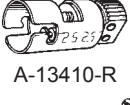
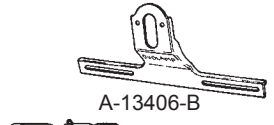
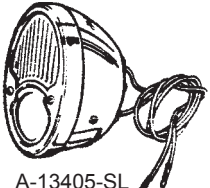
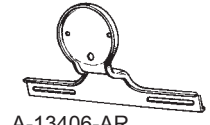

# Model A Parts

All prices listed in catalog subject to change. Call for current prices.

Part #	Description	Reqd.	Years	Price
<b>Tail Lamps</b>				
A-13466-HAL	Halogen Tail/Dome/Dash/Cowl Bulb. Uses original base for easy installation.		1919-31	17.00 ea.
A-13466-HP	Brighter Tail & Cowl Lamp Bulb. This higher candlepower bulb doubles light output. 6 cp. 6 volt.		1919-36	1.25 ea.
A-13471-AL&AR	Mud Shield. This shield fits at rear of tail lamp & protects the wiring from mud. Comm.	1	1929-48	4.95 ea.
A-13467-SS	Stainless Steel Mud Shield. Fits at rear of tail lamp and protects the wiring from mud. Comm.	1	1929-48	6.95 ea.
A-13468	Tail Lamp Bracket Mounting Bolt Set. (9 pcs)	1	1929-31	1.95 set
A-13468-SS	Tail Lamp Bracket Mounting Bolt Set. Stainless steel. (9 pc. set).	1	1929-31	3.50 set
A-13470	Pickup Tail Lamp Bracket for A-13405-SL. 1929-30 & 1929-31 AA Truck. Also V-8 Pickup thru 1937.	1		18.95 ea.
A-13470-AR	Drum Style Tail Lamp Bracket. Malleable iron casting. Pickup, Panel Truck & Bus.	1	1928-29	14.95 ea.
A-13470-W	Oak Block for Tail Lamp Bracket. Pickup. Used for mounting taillight bracket under side of left rear pickup box. Includes 6 pc. mounting bolt set.	1	1928-31	4.50 ea.
A-13471-AL	Drum Style Tail Lamp Bracket. Bolts to lower body corner. Driver's side. Malleable iron. Coupe and Roadster.	1	1928-29	14.95 ea.
A-13471-AR	Drum Style Tail Lamp Bracket. Bolts to lower body corner. Malleable iron. Passenger side. Coupe and Roadster.	1	1928-29	19.95 ea.
A-13471-B	Tail Lamp Bracket. Driver's side.	1	1929-31	6.95 ea.
A-13471-BC	<b>New</b> Tail Light Bracket Chrome, Left Side.			10.95 ea.
A-13471-RC	<b>New</b> Tail Light Bracket Chrome, Right Side.			10.95 ea.
A-13471-BS	Drum Tail Lamp Bracket Bolt Set. These bolt AR brackets to rear corners of frame.	1	28- 7/29	1.00 set
A-13471-R	Tail Lamp Bracket. Passenger's side.	1	1929-31	7.95 ea.
A-13472	Tail Lamp Bracket Rubber Pad. Fits between bracket & fender.	1	1929-31	1.00 ea.
A-13472-B	Tail Lamp Bracket. Fits 1929-31 Commercial Vehicles & Station Wagons: 1930-31 Panel, Dlx. Pickups, Dlx. & Special Deliveries.	1		13.95 ea.
A-13480-AR	Stop Light Switch. Duplicate of original. Bolts to side of transmission.	1	1928-29	9.95 ea.
A-13480-B	Stop Light Switch. Duplicate of original. Bolts to frame cross member.	1	1930-31	9.95 ea.
A-13480-BS	Stop Switch to Cross Frame Mounting Bolts. (6 pc. set)	1	1930-31	1.00 set
A-13507	Stop Light Switch Link to A-2457 Pin.	1	1928-29	1.00 ea.
<b>Dash &amp; Dome Lights</b>				
A-13705-AR	Dash Lamp Assembly. Chrome plated. Duplicate of original. Fits A-11805-AR.	1	1928-30	22.95 ea.
A-13705-C	Dash Lamp Assembly w/ Switch & Bracket. Fits under dash rail. For Closed Car.	1	1930-31	23.95 ea.
A-13705-O	Dash Lamp Assembly w/ Switch & Bracket. Fits under dash rail. Open Car.		1930-31	23.95 ea.



A-13471-AL&AR



A-13467



A-13470-AR

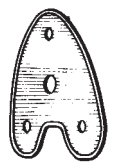

A-13471-AR

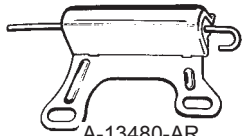

A-13480-AR

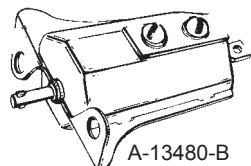

A-13480-B

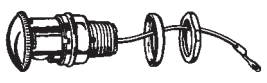

A-13705-C

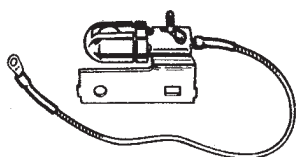

A-13705-O

Part #	Description	Reqd.	Years	Price
<b>Dash &amp; Dome Lights</b>				
A-13708-AR	Chrome Cap only for A-13705-AR.	1	1928-30	11.95 ea.
A-13708-C	Chrome Cap only for A-13705-C.	1	1930-31	11.95 ea.
A-13769	Dome Lamp Switch on Pillar. As original. Use with A-13770.	1	1928-48	9.95 ea.
A-13770	Dome Lamp Switch Plate Cover. Nickel plated. Use with A-13769.	1	1928-48	2.95 ea.
A-13771	Dome Lamp Assembly. No built in switch.	1	1928-31	41.95 ea.
A-13776	Dome Lamp Assembly with Built-in Switch. Coupe & Tudor.	1	1928-31	54.95 ea.
A-13776-W	Wood Mounting Block for Dome Light. Fits between the roof ribs. Coupe.	1	1930-31	9.95 ea.
<b>Horn</b>				
A-13802	Sparton™ Horn Assembly w/Bracket & Sparton™ Horn Plate. 6 volt. Black powder coated. USA.	1	1928-31	299.95 ea.
A-13802-M	Non-original Horn. 12 volt only. Economy horn. Great sound.		All years	24.95 ea.
A-13802-T	Sparton™ Horn Assembly w/Bracket & Sparton™ Horn Plate, 12 volt. (Horn plate will not indicate 12 volt)	1	1928-31	310.00 ea.
A-13805-B	Horn Bracket. Die formed steel.	1	1928-31	1.95 ea.
A-13806	Ahoogah Horn Data Plate w/Nickeled Rivets. 6 volt.	1	1928-31	1.00 ea.
A-13807	Horn Bell Assembly w/Flange. To fit A-13802 Sparton™ Horn.	1	1928-32	64.95 ea.
A-13808	Horn Motor Cover Screw & Lock Washer Set. For motor driven horns.	1	1928-32	1.00 set
A-13809	Horn Motor Cover w/Adjust On It. (1 pc. style) Fits other style horns of the era.	1	1928-31	12.95 ea.
A-13809-FS	Sparton™ Horn Cover w/Script. 2 pc. style. Ford script & Sparton™ end.	1	1928-31	19.95 ea.
A-13809-S	Horn Motor Cover. 2 pc. style. Stamped Sparton™ & adjust..	1	1928-31	11.95 ea.
A-13811	Horn Diaphragm. Spring steel w/ forged hardened lug.	1	1928-31	8.95 ea.
A-13812	Horn Diaphragm Gaskets. Die stamped fiber.	1	1928-32	1.00 pr.
A-13816	Horn Rim Bolt Set. (12 pc. set)	1	1928-32	2.95 set
A-13817-S	Horn Motor Brushes & Spring.	1	1928-32	3.95 set
A-13840	Horn Bell Screen. Domed brass mesh. Non rusting.	1	1928-32	1.95 ea.
<b>Wiring</b>				
A-14300	Battery to Starter Cable. 19" long. Fits negative post. A-14550-B support also used.	1	1928-31	12.95 ea.
A-14300-D	Battery Disconnect Switch. Cuts off battery current. 6 or 12 volt. Uses 16" cable.	1	1928-31	26.95 ea.
A-14300-DB	Mounting Bracket for A-14300-D. Mounts the battery disconnect switch on lower motor bolt to clear steering column and frame. USA.	1	1928-31	6.95 ea.
A-14300-S	Battery Disconnect Switch. Fits on terminal post. 6 or 12 volt. Made in USA.	1	1909-54	9.95 ea.

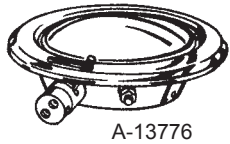

A-13776



A-13802-M



A-13805-B

A-13806

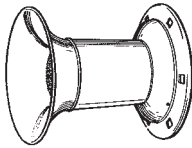

A-13807

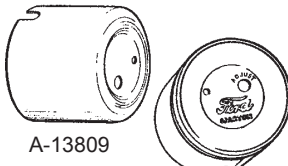

A-13809

A-13809-FS

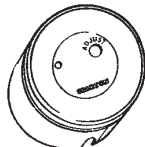

A-13909-S

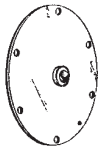

A-13811

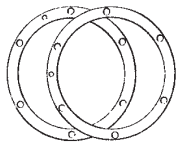

A-13812



A-13840

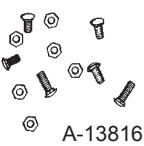

A-13816





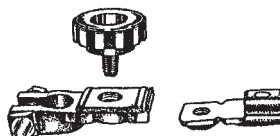

A-14300

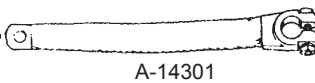
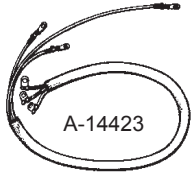

A-14300-S

# Model A Parts

All prices listed in catalog subject to change. Call for current prices.

Part #	Description	Reqd.	Years	Price
<b>Wiring</b>				
 A-14301	A-14301 Ground Connector Strap. Braided ground strap with tinned battery terminal.	1	1919-31	11.95 ea.
A-14302	A-14302 Ignition Coil Wire to Distributor. Black lacquered wire.	1	1928-31	2.95 ea.
A-14302-M	<b>New</b> A-14302-M Modern Coil Wire, with crimped ends and rubber boots for a better contact.			4.95 ea.
A-14305	A-14305 Coil to Terminal Box Wire. Fits passenger + side of coil until Nov. 1929, then moved to driver's side thru end of production. 24" x 28".	1	1928-31	2.25 ea.
 A-14423	A-14350-A Wiring Diagram for Cars with Cowl Lights. Fully detailed with color code identity. 24" x 28" Poster.	1	1928-31	5.95 ea.
A-14350-B	A-14350-B Wiring Diagram for Cars Without Cowl Lights. Fully detailed with color code identity. 24" x 28" Poster.	1	1928-31	5.95 ea.
 A-14401-B	A-14401-B Dash Wiring Harness. The short harness from the terminal box to ammeter. (Red wire to - driver's side until Nov. 1929. then + passenger side to end)	1	1928-31	15.95 ea.
A-14403-A	A-14403-A Wiring Harness. 1 bulb style for cars with cowl lights.	1	1928-31	72.95 ea.
A-14403-C	A-14403-C Wiring Harness. 2 bulb style for cars without cowl lights.	1	1928-31	74.95 ea.
 A-14406-AR	A-14406-AR Generator to Terminal Box Wiring Harness in Steel Tube.	1	1928-30	22.95 ea.
A-14406-B	A-14406-B Generator to Terminal Box Harness. This runs from generator cutout to starter switch & terminal box.	1	1928-31	18.95 ea.
A-14422-AR	A-14422-AR Tail Lamp Extension Wire with Proper Loom. For drum tail lamps.	1	1928	5.95 ea.
A-14423	A-14423 Tail Lamp Crossover Wire Loom. Used when adding right rear tail lamp.	1	1928-40	19.95 ea.
A-14426	A-14426 Cowl Light Wire Harness. Connects cowl lights to A-14403-A wire set.	1	1928-34	15.95 ea.
A-14464	A-14464 Flag Terminal. Original style tinned brass.	1	1928-31	.50 ea.
 A-14487	A-14487 Wire Sleeve Connectors. Used to connect the various sections of a wiring harness. Rubber covered metal sleeves. (5 pcs.) (Need 2 sets for 1935-48).	1	1928-48	2.25 set
A-14488	A-14488 Wiring Bullet Terminals. Solder to wire ends. (5 pcs.)		1928-48	1.95 set
 A-14550-B	A-14550-B Battery Cable Support w/ Grommet at Clutch Housing. Prevents shorting of A-14300 cable.	1	1930-31	2.95 ea.
A-14560-G	A-14560-G Terminal Box Grommet. Fits ignition cable where it enters terminal box. Also battery cable.	1	1928-31	1.00 ea.
A-14560-S	A-14560-S Terminal Box Set. Ready to mount on firewall.	1	1928-31	11.95 set
A-14561-A	A-14561-A Terminal Box Lid.	1	1928-31	3.95 ea.
A-14561-WN	A-14561-WN Terminal Box Wing nuts. Brass. 1 pair.	1	1928-31	2.00 pr.
A-14564	A-14564 Cowl Light Wire Connector & Clip. The special connector used to connect A-14426 to the main harness at base of steering column.	1	1928-29	8.50 ea.

All prices listed in catalog subject to change. Call for current prices.

Part #	Description	Reqd.	Years	Price
<b>Wiring</b>				
A-14564-B	Cowl Light Wire Connector & Clip. The special connector used to connect A-14426 to the main harness at base of steering column.	1	1930-31	8.50 ea.
A-14567-B	Speedometer Cable Housing Grommet. At firewall below choke rod.	1	1929-34	.50 ea.
A-14577	Steel Conduit Clip. Holds upper part of A-14406-AR to firewall below & towards driver's side.	1	1928-30	1.75 ea.
A-14577-A	Wiring & Speedometer Cable Clip. Holds A-14406-B to water inlet and firewall near terminal box. Holds 1/2" speedometer cable housing also.	2	1928-30	1.50 ea.
A-14577-B	Clip. Used to hold smaller speedometer cable housing to inside of firewall.	1	1929-32	1.50 ea.
A-14578-ARS	Horn & Headlight Wire Conduit Set. Smaller diameter conduit w/ 1/2" ferrules to fit 1928.	1	1928	15.95 set
A-14578-S	Horn & Headlight Conduit Cover Set. Stainless steel 1/2" Conduit w/ 9/16" ferrules.	1	1928-31	12.95 set
A-14582	Conduit Set for Horn & Headlight Wires. Non-metallic black lacquer. AA chassis.	1	1930-31	36.95 set
A-14584	Headlight Plugs. 3 hole style. Aligns & holds headlight wiring at base of headlight shell to fit sockets.	1	1929-32	1.95 pr.
A-14584-AR	Headlight Wire Plugs. Early style for 1/2" sockets with special brass terminals & screws. .665" o.d. Fits base sockets to hold wires apart. Prevents shorts.	1	1928-early '29	9.95 pr.
A-14585	Wiring Clip Set. Holds wiring on to frame. Black enameled. (10 per set)	1	1928-48	1.75 set
A-14593-AR	Cowl Light Crossover Wire Support Clip & Grommet.	3	1928-29	2.25 ea.
A-14593-B	Cowl Light Crossover Wire Support Clip & Grommet.	3	1930-31	2.25 ea.
A-14595	Drum Tail Light Wire Clips. Holds wiring to T/L bracket on all body styles using the drum style tail light. USA.	1	1928-29	2.75 pr.
A-14598	Headlight Wire Clip on Frame. This clip fits under left front hood latch at rear screw to prevent chaffing of headlight wiring.	1	1929-32	1.75 ea.
A-14600-AS	Firewall Grommet Set. The proper grommets for your firewall. (6 pc. set)	1	1928-31	4.95 set



A-14577-A



A-14577-A



A-14578-ARS



A-14584-AR



A-14585

A-14593-AR



A-14593-B



A-14595



A-15028

## Roadster & Roadster Pickup Bodies

**High Quality, All Steel Bodies Mfg. for us by Brookville in Ohio**

These are fully assembled stock bodies less the gas tank. Each has opening doors. Fully wooded. Stock floor pans installed. Numerous options for street rodders are available. Please Note: Truck shipping only—Crating charge extra.

A-15028	Roadster Body. All steel. Includes rumble lid. (approximate crating charge - \$400.00)	1928-29	7,300.00 ea.
A-15029	Roadster Pickup Body. All steel. Order TK-100 bed separately. (approximate crating charge - \$350.00)	1928-29	5,300.00 ea.

# Model A Parts

Part # Description Req'd. Years Price

## Roadster & Roadster Pickup Bodies

A-15030	Roadster Body. All steel. Includes rumble lid. (approximate crating charge - \$400.00)	1930-31	7,300.00 ea.
A-15031	Roadster Pickup Body. All steel. Order TK-100 bed separately. (approximate crating charge - \$350.00)	1930-31	5,300.00 ea.



A-15030



1928-29 Front Fender

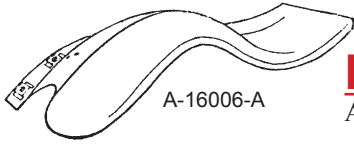

A-16006-A

## Ford Front Fenders Original gauge steel serrated wire bead

A-16005-A	<b>Front Fender.</b> Right side, <b>Plain.</b> Die stamped steel. Made in USA.	1	1928-29	510.00 ea.
A-16005-AW	<b>Front Fender.</b> Right side w/ <b>Wheel Well</b> Installed for spare. Die stamped steel. USA.	1	1928-29	635.00 ea.
A-16006-A	<b>Front Fender.</b> Left side, <b>Plain.</b> Die stamped steel. Made in USA.	1	1928-29	510.00 ea.
A-16006-AW	<b>Front Fender.</b> Left side w/ <b>Wheel Well</b> installed for spare. Die stamped steel. USA.	1	1928-29	635.00 ea.
A-16005-C	<b>Front Fender.</b> Right side, <b>Plain.</b> Die stamped steel. Made in USA.	1	1930-31	475.00 ea.
A-16005-CW	<b>Front Fender.</b> Right side w/ <b>Wheel Well</b> installed for spare. Die stamped Steel. USA.	1	1930-31	600.00 ea.
A-16006-C	<b>Front Fender.</b> Left side, <b>Plain.</b> Die stamped steel. Made in USA.	1	1930-31	475.00 ea.
A-16006-CW	<b>Front Fender.</b> Left side w/ <b>Wheel Well</b> installed for spare. Die stamped steel. USA.	1	1930-31	600.00 ea.
A-16019	Fender to Bracket Bolt Set. Stainless steel. Used front & rear. (12 pc. set)	1	1928-29	2.50 set
A-16020	Fender Bracket Clip. Fits inner rim of fender where it bolts to bracket. Used front & rear.	1	1928-31	6.50 ea.
A-16021	Fender to Bracket Bolt Set. Stainless steel. Fender edge to bracket. Used front or rear. (12 pc. set).	1	1928-32	3.95 set
A-16024	Front Fender Brackets to Frame Bolt Set. (18 pc. set).	1	1928-29	3.95 set
A-16025-A	Front Fender Bracket. Stamped steel. USA.	2	1928-29	42.50 ea.

1930-31 Welled Front Fender

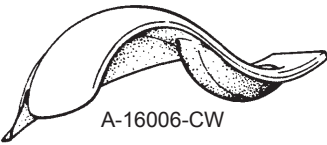

A-16006-CW

1930-31 Plain Front Fender

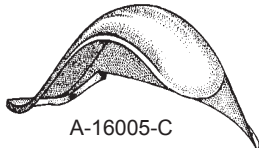

A-16005-C



A-16020

A-16025-A



**Save a tree and get more frequent updates by visiting [www.GaslightAuto.com](http://www.GaslightAuto.com) and download our digital catalog.**

**See Part # A-16532/3-R for more**

All prices listed in catalog subject to change. Call for current prices.

**Part # Description Req'd. Years Price**



## 1930 Front Fender Shields

The following fit all 1930 Body Styles – Gaslight Product – Made in

### USA

A-16025-B	Front Fender Bracket. Stamped steel. USA.	2	1930-31	42.50 ea.
A-16026	Front Fender Bracket to Frame Bolt Set. 18 pcs.	1	1930-31	2.95 set
A-16028	Fender Well w/ Drain Hole. Holds spare tire in front fender.		1928-29	39.95 ea.
A-16031	Fender Well with Drain Hole. Stamped steel. 19 gauge. USA. Holds a spare tire in front fender.		1930-31	32.50 ea.
A-16050-R	Front Fender Shield. Right hand. Die stamped to fit 1930. This is the short apron that is welded to the fender.	1	1930	69.95 ea.
A-16050-RS	Front Fender Shield. Right hand w/ side Mount Hole. This is the short apron that is welded to the fender.	1	1930	79.95 ea.
A-16051-R	Front Fender Shield. Left hand. Die- stamped to fit 1930. This is the short apron that is welded to the fender.	1	1930	69.95 ea.
A-16051-RS	Front Fender Shield. Left hand w/ side mount hole. This is the short apron that is welded to the fender.	1	1930	79.95 ea.

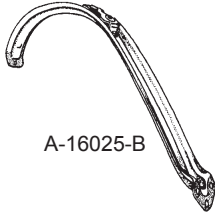

A-16025-B



A-16031

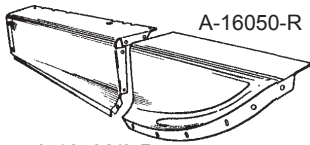

A-16050-R

A-16532/3-R

## Rear Fenders & Brackets

Mfg. in Ohio stamped on our steel dies. Thousands Sold.

A-16160-ARQ	Rear Fender. Right hand. This Fender is from another manufacturer. Fits Coupe, Roadster, Cabriolet and Pickup. Excellent quality.	1	1928-29	410.00 ea.
A-16160-BQ	Rear Fender. Right hand. This Fender is from another manufacturer. Fits Coupe, Roadster, Cabriolet and Pickup. Excellent quality.	1	1930-31	410.00 ea.
A-16161-ARQ	Rear Fender. Left hand. This Fender is from another manufacturer. Fits Coupe, Roadster, Cabriolet and Pickup. Excellent quality.	1	1928-29	410.00 ea.
A-16161-DQ	Rear Fender. Left hand. This Fender is from another manufacturer. Fits Coupe, Roadster, Cabriolet and Pickup. Excellent quality.	1	1930-31	410.00 ea.
A-16180-A	Rear Fender Brackets. Die formed steel. Coupe, Roadster & Pickup.	1	1928-29	21.50 pr.
A-16180-B	Rear Fender Brackets. Die formed steel. Coupe, Roadster & Pickup.	1	1930-31	21.50 pr.
A-16195	Rear Fender Bracket Bolt Set. Mounts brackets to body. (18 pc. set)	1	1928-31	2.95 set
A-16200	Rear Fender Housing Stud Set. (Braze studs to body) (4 pc. set) 2 sets required.	2	1928-31	2.50 set
A-16340-AR	Rear Fender Brackets. Die-formed steel. Sedan & Phaeton.	1	1928-29	43.50 pr.
A-16340-B	Rear Fender Brackets. Die-formed steel. Sedan & Phaeton.	1	1930-31	43.50 pr.



A-16340-B

All prices listed in catalog subject to change. Call for current prices.

# Model A Parts

All prices listed in catalog subject to change. Call for current prices.



A-16350

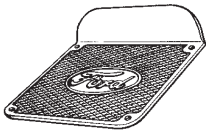

A-16400



A-16450-A

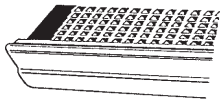

A-16450-C



A-16462-AS

Part #	Description	Reqd.	Years	Price
<b>Welt, Webbing, &amp; Mounting Pads</b>				
<b>NOTE: All 1934 Steel Fenders temporarily out of production. Please Inquire.</b>				
A-16345	Black Fender Welt. 25 ft. roll. 3/16" dia bead. 1-1/2" wide.	1	1928-31	10.95 roll
A-16350	Chassis Webbing. Treated cotton. 20 ft. roll.	1	1928-32	15.95 roll
A-16352	Body Mounting Pad Set. All Models. Pads fit between frame & blocks.	1	1928-31	5.95 set
A-16353	Cowl Shim Set. (6 pcs.) Used under the cowl to align the doors & hood.	1	1928-31	2.95 set

## Running Board Assemblies & Components

A-16400	Running Board Step Plates. 'Ford' in the oval.	1	1928-31	54.95 pr.
A-16400-MB	Running Board Step Plate Mounting Screw & Nut Set. (16 pc. set)	1	1915-31	1.95 set
A-16450-A	Running Boards. Ribbed rubber & zinc trim installed. Passenger Car.	1	1928-29	305.00 pr.
A-16450-AS	Smooth Running Boards for Custom Look.	1	1928-29	275.00 pr.
A-16450-AST	Running Boards. Ribbed rubber & highly polished stainless steel trim. Passenger Car.	1	1928-29	305.00 pr.
A-16450-B	Running Boards w/ Shields Attached. Includes pyramid rubber & zinc trim. Ready to paint & install. Passenger Car.	1	1930	349.95 pr.
A-16450-BSS	Running Boards w/ Shields. Pyramid rubber & highly polished SS trim. Passenger Car.	1	1930	395.00 pr.
A-16450-BST	Running Boards. Pyramid rubber & highly polished SS trim. Fits A-16532/3-R Pass. Car.	1	1930	305.00 pr.
A-16450-C	Running Boards. Pyramid rubber covered w/ zinc outer trim. Passenger Car.	1	1931	305.00 pr.
A-16450-CS	Smooth Steel Running Boards for Custom Look.	1	1930-31	295.00 pr.
A-16450-CST	Running Boards. Highly polished stainless steel trim. Pyramid rubber. Passenger.	1	1931	305.00 pr.
A-16455-A	Running Board Matting. Ribbed type.	1	1928-29	26.95 pr.
A-16455-B	Running Board Matting. Pyramid type.	1	1930-31	37.95 pr.
A-16459-T	Running Boards. Stamped steel w/ diamond design & Ford script to fit Commercial Vehicle.	1	1928-29	274.95 pr.
A-16460-T	Running Boards. Stamped steel w/ diamond design to fit Commercial Vehicle & Pickups.	1	1930-31	274.95 pr.
A-16461-AA	Running Boards. Stamped steel w/ diamond design. 29-1/2" long. AA Trucks.	1	1930-31	217.50 pr.
A-16462-AS	Running Board Strip Set. Zinc coated steel. (Set of 8 pcs.)	1	1928-29	59.95 set
A-16462-AST	Running Board Strip Set. Stainless steel. Highly polished. Passenger Car. (8 pc. set)	1	1928-29	95.00 set
A-16462-BS	Running Board Strip Set. Zinc coated steel. (Set of 8 pcs.)	1	1930	59.95 set
A-16462-BST	Running Board Strip Set. Highly polished stainless steel. Pass. Car. (8 pc. set)	1	1930	95.00 set
A-16462-CS	Running Board Strip Set. Zinc coated steel. (Set of 2 pcs.)	1	1931	33.95 set
A-16462-CST	Running Board Strip Set. Stainless steel. 2pc set.	1	1931	95.00 set



All prices listed in catalog subject to change. Call for current prices.

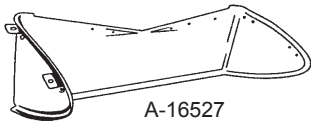

A-16527

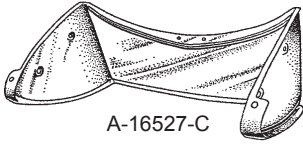

A-16527-C

**See part #  
A-16050  
for more**

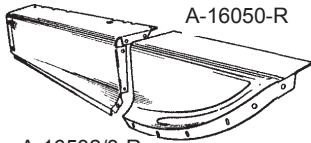

A-16050-R

A-16532/3-R

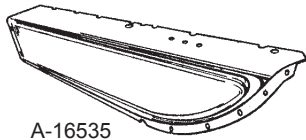

A-16535

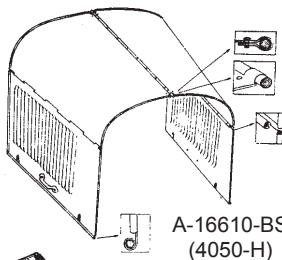

A-16610-BS  
(4050-H)



A-16622



A-16622-R



A-16718-PC

Part #	Description	Reqd.	Years	Price
<b>Radiator Splash Aprons</b>				
A-16527	Radiator Splash Apron. Die stamped steel. Black primer coated.	1	1928-29	37.95 ea.
A-16527-A	Street Rod Style Radiator Apron with 3" Chop.	1	1928-29	89.95 ea.
A-16527-C	Radiator Splash Apron. Die stamped steel. Black primer coated.	1	1930-31	39.95 ea.
A-16527-D	Radiator Splash Apron. Original style. Die stamped. Provides final touch to your 1930-31. USA.	1	1930-31	69.95 ea.
A-16527-R	Street Rod Radiator Apron. Designed for the classic 1932 shell on a 1930-31 chassis.	1	1930-31	115.00 ea.
A-16529-AR	Front Radiator Splash Apron Pads w/Rivets.	1	1928-29	1.25 set
A-16529-B	Front Radiator Splash Apron Pad w/Rivets.	1	1930-31	1.25 set

## Running Board Aprons









A-16532/3-R	Running Board Shields. Die stamped. Fastens to A-16050/51-R. Same length as the running boards. Used January 1930 to September 1930.	1	1930	205.00 pr.
A-16535	Running Board Shield. Right side. One piece style. Die stamped steel. Trophy quality. Used September 1930 thru 1931.			119.95 ea.
A-16536	Running Board Shield. Left side. One piece style. Die stamped steel. Trophy quality. Used Sept. 1930 thru 1931			119.95 ea.
A-16535/6-AR	Running Board Shields to Fit Early AR Only. Without hump.	1	1928	249.95 pr.
A-16535/6-B	Running Board Shields. With hump for emergency brake arms.	1	1928-29	249.95 pr.
A-16538	Running Board Shield. Right side. One piece style with hole for side mount arm. Die stamped steel. Trophy quality.	1	1931	129.95 ea.
A-16539	Running Board Shield. Left side. One piece style with hole for side mount arm. Die stamped steel. Trophy quality.	1	1931	129.95 ea.

## Hood

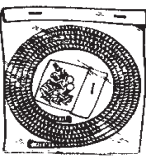
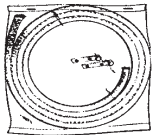
A-16610-A	Hood Assembly. Exact duplicate. Trophy quality.	1	1928-29	529.95 ea.
A-16610-AS	Hood Hinge Rod Set. Stainless steel. (3 pcs.)	1	1928-29	22.95 set
A-16610-B	Hood Assembly. Exact duplicate. Trophy quality.	1	1930-31	539.95 ea.
A-16610-BS	Hood Hinge Rod Set. Stainless steel. (3 pc. set)	1	1930-31	24.95 set
A-16622	Hood Corner Pads w/Rivets. Leather. Used on rear corners of hood only.	1	1928-31	2.95 pr.
A-16622-R	Hood Corner Pads. Formed rubber. Popular accessory of the time.	1	1928-31	2.95 pr.
A-16713/14-S	Hood Shelves w/ Holes Drilled & Inner Brackets.	1	1928-29	52.95 set
A-16718-PC	Hood Inner Bumpers & Brackets. The brackets & rubber bumpers which press on inner center of hood. Powder coated black. USA.	1	1930-31	9.95 pr.

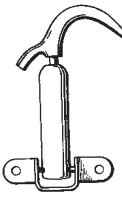
# Model A Parts

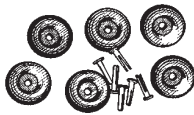
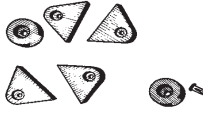
All prices listed in catalog subject to change. Call for current prices.

Part #	Description	Reqd.	Years	Price
<b>Hood</b>				
 A-16727-S	A-16727-S Hood Shelf Support Block Set. Special wooden blocks fit under A-16713/14-S.	1	1928-29	6.95 set
 A-16735-AR	A-16735 -AMB Rear Hood Hinge Bracket Mounting Hardware. (Rencal)	1	1928-29	.95 set
 A-16735-C	A-16735-AR Rear Hood Bracket. Holds center hood rod in place. Passenger & Commercial Vehicles.	1	1928-29	6.95 ea.
	A-16735-B Rear Hood Bracket. Holds center hood rod in place. Standard Passenger & Commercial.	1	1930-31	6.95 ea.
	A-16735-C Rear Hood Bracket. Chrome plated. Holds center hood rod & fits over cowl band. Deluxe Passenger Car & Commercial Vehicles.	1	1930-31	7.95 ea.
 A-16739 (48-16739-S)	A-16739 Radiator Shell Lacing Kit w/Raven Rivets. Treated cotton.	1	1928-31	7.95 set
	A-16740-AR Cowl Lacing Kit. Wire-in style as original w/ special hook & nut. Instructions included.	1	1928-29	16.95 kit
	A-16740-BS Cowl Lacing Kit with Clips.	1	1930-31	21.95 kit
 A-16740-BS	A-16740-CB Cowl Band with Mounting Brackets. Polished stainless steel.	1	1930-31	74.95 ea.
	A-16750-AR Hood Latch Assembly. 3 hole mounting.	4	1928-29	10.50 ea.
	A-16750-ARS Hood Latch Assembly. 3 hole mounting. Polished stainless steel.	4	1928-29	11.95 ea.
	A-16750-AS Hood Latch Screw & Nut Set. Stainless. (36 pcs.)	1	1928-29	3.95 set
 A-16750-AR	A-16750-B Hood Latch Assembly. 2 hole mounting.	4	1930-31	9.95 ea.
	A-16750-BS Hood Latch Screw & Nut Set. Stainless steel. (24 pc. set)	1	1930-31	3.95 set
 A-16750-B	A-16750-BSS Hood Latch Assembly. 2 hole mounting. Polished stainless steel.	4	1930-31	12.95 ea.
	A-16754 Hood Latch Rubber Mounting Pads. Fits under latch to protect the paint. (4 pc. set) (Used with 3 screw mounting latches)	1	1928-29	3.50 set
	A-16754-B Hood Latch Rubber Mounting Pads. Fits under latch to protect paint. (4 pc. set) (Used with 2 screw mounting latches)	1	1930-31	3.50 set
 A-16755-S	A-16755-S Hood Handle Protectors. Prevents paint damage. (Set of 8)	1	1928-31	1.25 set
	A-16761-A Hood Bumper Set w/Rivets. (6 pcs.)	1	1928-29	3.95 set
 A-16761-A	A-16761-B Hood Bumper Set w/Rivets. (6 pcs.)	1	1930-31	4.95 set
	A-16780-F Hood Support Set. Stainless steel.	1	1928-36	29.95 set
<b>Closed Car Top Parts</b>				
	A-16800 Top Material. Cobra long grain. Black waterproof material. Fits most Open or Closed Vehicles. 65" wide.	1	1909-31	4.95 ft.
	A-16804 Hidem Welt. Black bison grain. Open & Closed Vehicles.		1928-31	.50 ft.
 A-16761-B	A-16806 Rain Gutter Molding Set. Aluminum 2 pc. type. Consists of two 4' sections. Coupe only.	1	1915-31	19.95 set
 A-16780-F	A-16807 Rain Gutter Molding Set. Aluminum 2 pc. type. Consists of two 7' 6" sections. Sedan only.	1	1928-31	29.95 set
	A-16810 Top Molding. Extruded alum. Fits front edge of top. Duplicate of original 5/8" Wide. 5 ft. length. Fits 45B Coupe, 155 ABCD & 170 AB.	1	1928-31	12.95 ea.

**Part # Description Req'd. Years Price**

## Closed Car Top Parts

A-16812	Top Molding. Extruded aluminum. Fits front edge of top. Duplicate of original. 1/2" wide flat bottom, 5 ft. length. Fits 55B Tudor, 82B Pickup.	1	1930-31	12.95 ea.
A-16813	Top Molding. Extruded aluminum. Fits front edge of top. Duplicate of original. Fits Slant W/S Sedans # 160 A-B-C. Briggs & Murray Bodies.	1	1931	14.95 ea.
A-16815	Top Molding. Extruded aluminum. Rib bottom fits sides & rear. 5/8" wide & 5' long. Coupe & Sedan. Order 2 for Coupe, 4 for Sedan.		1928-31	14.95 ea.
A-16818	Top Covering Kit. Includes black long grain top material, foam padding, hide'um, tacks, sealant & instructions. Coupe only. <b>Specify Year.</b>	1	1928-31	179.95 kit
A-16820	Top Covering Kit. Includes black long grain top material, foam padding, hide'um, tacks, sealant & instructions. Tudor & Fordor Sedan.	1	1928-31	139.95 kit

## Tools

A-2228-T	Bushing Driver Tool.	1	1909-34	7.95 ea.
A-4235-WP	Wheel Puller. Knock-off type. Case hardened.	1	1912-48	2.95 ea.
A-6510-T	Valve Guide Remover Tool.	1	1928-34	5.95 ea.
A-7550-T	Clutch Alignment Tool.	1	1929-40	4.95 ea.
A-8523-W	Water Pump Pack Nut Wrench.	1	1928-34	1.95 ea.
A-9300-S	Gas Gauge Tool Set.	1	1928-31	6.95 set
A-17005	Tool Pouch. Black. Duplicate of original. Short cobra grain decking.	1	1928-32	9.95 ea.
A-17029	Locking Steel Tool Box. Fits between frame horns deflecting air flow to the radiator. Powder coated black.	1	1928-29	199.95 ea.
A-17031	Locking Steel Tool Box. Same as above.	1	1930-31	199.95 ea.
A-17036	Crank & Wheel Lug Nut Wrench.	1	1928-31	19.95 ea.
A-17052-ADP	Tire Pump Adapter. A must for any original or repro tire pump.	1	All years	24.95 ea.

## Speedometer

A-17255-AR	Speedometer Assembly. Oval Face Style. Completely rebuilt. Stewart/Warner only. <b>Sold Exchange Only.</b>	1	1928-30	279.95 ex.
A-17255-D	Speedometer Assembly, Round. Rebuilt. Stewart Warner. <b>Sold exchange only.</b> Used from May 1930 thru 1931.	1	1930-31	229.95 ex.
A-17255-MB	Speedometer Mounting Screw Set. Mounts speedometer to instrument panel (6 pc. set).	1	1928-31	1.00 set
A-17255-O	Speedometer Decals for Oval Face Speedometer.	1	1928-30	2.25 ea.
A-17255-R	Speedometer Decals for Round Stewart and Walthams Speedometers.	1	1930-31	2.25 ea.
A-17256-AS	Speedometer Lens & Gasket Set. Oval Speedo.	1	1928-30	1.95 set

A-6510-T



A-7550-T



A-9300-S

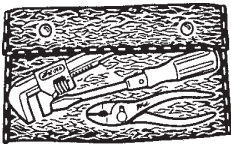

A-17005

A-17036

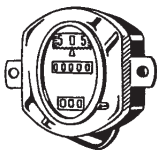
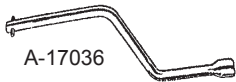

A-17255-AR



A-17255-O

# Model A Parts

All prices listed in catalog subject to change. Call for current prices.

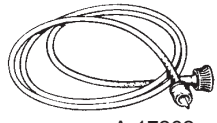

A-17262



A-17265-AR



A-17265-B



A-17273-B



A-17275



A-17290

Part #	Description	Reqd.	Years	Price
<b>Speedometer</b>				
A-17256-BS	Speedometer Lens & Gasket Set. Round Speedo. Late 1930 & All 1931.	1		1.95 set
A-17260-A	Speedometer Cable & Housing. Keyed metal shaft. 1/2" dia. housing. Keyed end fits at driveshaft. Used 1928 to June 1930.	1		29.95 ea.
A-17260-KS	Speedometer Internal Shafting w/ Keyed End, Less Housing. 61.50" long. The keyed end fits on driveshaft. Used 1928 - mid '30.	1		9.95 ea.
A-17261	Speedometer Shafting. Less housing. Square end. 61.50" long.	1	1930-34	10.95 ea.
A-17262	Speedometer Cable & Housing. Square end cable in 19/64" diameter housing. Passenger & Commercial.	1	1930-34	19.95 ea.
A-17265-AR	Speedometer Cable to Frame Clip w/ Mounting Bolt. Large cable.	1	1928-29	3.95 ea.
A-17265-B	Speedometer Cable to Frame Clip w/ Mounting Bolt. Small cable.	1	1930-34	3.95 ea.
A-17270-DR	Speedometer Gear & Case Assy. Std. ratio 3:78/1. This fits on torque tube. Order A-17272 & A-17275 bolts & gasket. This is for round keyed cable. Gear is 18 tooth for use with 21" tires. USA.	1	1928-29	76.95 ea.
A-17270-FE	Speedometer Gear & Case Assy. Std. ratio 3:78/1. Fits early 1930 models using round key shaft. Gear is 19 tooth for use with 19" tires. USA.	1	1930	79.95 ea.
A-17270-FL	Speedometer Gear & Case Assy. Std. ratio 3:78/1. Fits 1930-31 models with squared end on both ends of cable. Gear is 19 tooth for use with 19" tires. USA.	1	1930-31	72.95 ea.
A-17272	Speedometer Gear Housing Screw Set. (4 pcs.)	1	1928-48	1.00 set
A-17273-A	Speedometer Drive Gear Shaft, Round Hole. Holds drive gear in cast case on the A-4505 torque tube. Accepts round cable end.	1	28-early '30	11.95 ea.
A-17273-B	Speedometer Drive Gear Shaft, Square Hole. Holds drive gear in cast case on the A-4505 torque tube. Accepts square cable end.	1	mid '30-1931	11.95 ea.
A-17274-A	Speedometer Gear Shaft Retainer. Round. Presses into threaded end of cast gear case. Holds round end shaft in place. Oval speedometer. USA.	1	28-early '30	1.25 ea.
A-17274-B	Speedometer Gear Shaft Retainer. Square. Presses into threaded end of cast gear case. Holds square end shaft in place. Round speedometer. USA.	1	late '30-1931	1.25 ea.
A-17275	Speedometer Gear Cap Gasket. Fits between gear cap & drive shaft housing.	1	1928-48	.25 ea.
A-17286	Speedometer Gear Snap Ring. Holds A-17285 gear on drive shaft.	1	1928-48	.50 ea.
A-17290	Speedometer Gear Thrust Washer. This fits between roller bearing & speedometer gear on drive shaft.	1	1928-48	1.95 ea.

**Part # Description Req'd. Years Price**

## Windshield Wipers

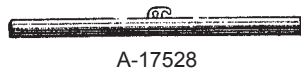

A-17528

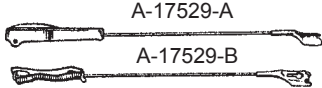

A-17529-A

A-17529-B

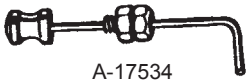

A-17534



A-17593-AS



A-17655-AR

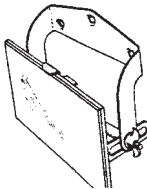

A-17686

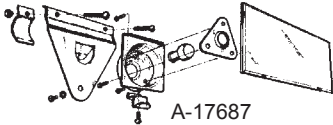

A-17687

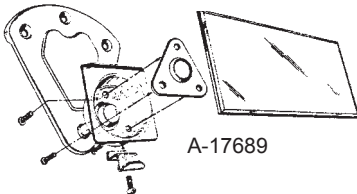

A-17689

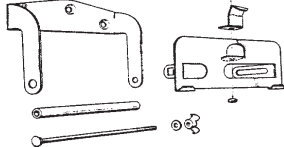
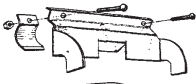

A-17684









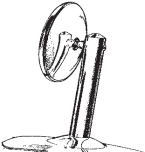
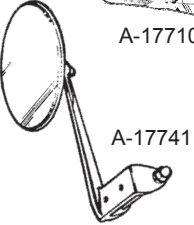

A-17704-AR

A-17508	Vacuum Wiper Motor. Trico brand. Outside mount. Rebuilt & tested. Closed Car & Truck.	1	1928-31	249.95 ea.
A-17508-C6	Electric Windshield Wiper Assembly. With arm & blade. Stainless steel. Inside mount. 6 volt.		1928-31	44.95 ea.
A-17508-C12	Electric Windshield Wiper Assembly. With arm & blade. Stainless steel. Inside mount. 12 volt.		1928-31	44.95 ea.
A-17515	Clips. Wiper hose on W/S frame. Open Car.	1	1928-32	2.95 pr.
A-17517-S	Windshield Wiper Rubber Hose. 6 ft.	1	1928-32	4.95 set
A-17521	Wiper Vacuum Tube w/ Mounting Clips. Mounts on driver's windshield post, 9". Stainless. Deluxe Open Car.	1	1930-32	6.95 set
A-17522	Wiper Vacuum Tube w/ Mounting Clips. Stainless. Mounts on driver's windshield post. 9-1/2". Open Car.	1	1930-31	7.95 set
A-17523	Grommet. Vacuum line to header. Upper & lower. Closed Car & Truck.	2	1928-31	.75 ea.
A-17528	Wiper Blade, 7-1/4". Fits all vacuum wipers.	1	1928-40	2.25 ea.
A-17528-B	Wiper Blade. 8-1/4". Fits all vacuum wipers.	1	1928-40	2.95 ea.
A-17529-A	Wiper Arm. Outside mount. Black. Coupe, Tudor & Closed Cab Pickup.	1	1928-31	6.95 ea.
A-17529-B	Wiper Arm for Inside Mount Motors. Chromed.	1	1928-36	6.95 ea.
A-17534	Vacuum Wiper Control Assembly. Closed Car and Truck.	1	1928-31	2.95 ea.
A-17540	Brass Manifold Connector for A-17543-B Vacuum Line.	1	1928-31	1.00 ea.
A-17541	Vacuum Wiper Fitting. Passes through firewall & connects manifold & header lines. Solid brass w/ cadmium nut.	1	1928-31	2.50 ea.
A-17543-B	Vacuum Line from Dash to Manifold.	1	1928-31	4.95 ea.
A-17544-B	Vacuum Line from Dash to Header. 36". Complete with covering & fittings. Closed Car.	1	1928-31	5.95 ea.
A-17546	Grommet. Vacuum line anti-rattler.	1	1928-31	.75 ea.
A-17593-AS	Windshield Wiper Motor Clamp Set. Open Car. (4 pc. set)	1	1928-31	3.50 set
A-17616	Clips. Holds wiper hose on wooden header. Closed Car & Truck. (3 pc. set)	1	1928-31	2.95 set
A-17655-AR	Hand Windshield Wiper. Chrome plated. Open Car and some Commercial.	1	1910-29	24.95 ea.
<b>Exact Duplicate Mirrors</b>				
A-17684	Mirror. Black. Assembled w/ glass. Open Car.	1	1923-29	18.95 ea.
A-17686	Mirror. Black. Assembled w/ glass. Closed Car.	1	1923-29	19.95 ea.
A-17687	Mirror. Stainless steel. Assembled w/glass. Open Car.	1	1930-31	27.95 ea.
A-17688	Mirror. Stainless steel. Assembled w/glass. Closed Car.	1	1930-31	29.95 ea.
A-17689	Mirror. Black. Assembled w/ glass. Closed Car.	1	1930-31	21.00 ea.
A-17700-AR	Post Mirror. Screws into windshield post. Stainless steel. Open Car & Truck.	1	1928-29	44.95 ea.
A-17700-P	Post Mirror. Screws into windshield post. Stainless steel. Open Car & Truck.	1	1930-31	44.95 ea.
A-17704-AR	Mirror Glass with Polished Bevel Edge. USA. 2-1/2" x 5".	1	1928-31	5.95 ea.

All prices listed in catalog subject to change. Call for current prices.

# Model A Parts

All prices listed in catalog subject to change. Call for current prices.

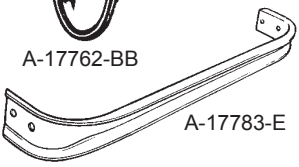
Part #	Description	Reqd.	Years	Price
<b>Bumpers</b>				
A-17710	Sidemount Mirror w/ Leather Strap. For fender mounted spare. High quality. Fits most Cars.		1928-34	44.95 ea.
 A-17710	A-17741-A Hinge Pin Mirror. Chromed. Fits either side. Fits 1-3/4" hinge only. (Not for Model T's)	1	1928-29	41.00 ea.
A-17741-BL	Hinge Pin Mirror. Chromed. Left side. Fits 1-5/8" hinge only. Closed Car.	1	1930-31	44.95 ea.
 A-17741	A-17741-BR Hinge Pin Mirror. Chromed. Right side. Fits 1-5/8" hinge only. Closed Car.	1	1930-31	44.95 ea.
A-17741-T	Outside Mirror. Painted black. Mounts on door post. Closed Cab Truck & Station Wagon.	1	1928-29	29.50 ea.
A-17741-TH	Outside Mirror. Hinge type. Closed Cab Truck.	1	1930-31	34.95 ea.
 78-18414	78-18414 Peep Mirror. Fits top door edge, left or right. Curved arm 4" Head. Promotes safety.	1	All	17.95 ea.
A-17752	Front Bumper Arms to Frame Bolt Set. Black oxide. (12 pc. set)	1	1928-29	3.95 set
A-17754/5-BR	Front Bumper Braces. Bolts to frame.	1	1928-29	89.95 pr.
 A-17741-T	A-17754/5-E Front Bumper Braces. Bolts to frame.	1	1930-31	89.95 pr.
A-17756-AR	Heavy Steel Backing Plate in the early style.	1	1928-30	3.25 ea.
 A-17754/5-BR	A-17756-PC Bumper Clamp Backing Plate. Stamped steel with diamond embossed reinforcement on back. Black powder coated.	4	1928-31	3.25 ea.
A-17757-A	Front Bumper Bars. Stainless steel. Complete with 2 bars (less end bolts & spacers).	1	1928-29	389.95 pr.
A-17757-D	Front Bumper Bars. Stainless steel. Complete with 2 bars (less end bolts & spacers).	1	1930-31	389.95 pr.
 A-17758-BC	A-17758-BC Bumper Clamp. Outer. Large size. Chrome plated. Die cast.	4	1928-29	13.95 ea.
A-17758-SC	Bumper Clamp. Outer. Large size. Stainless steel covered.	4	1930-31	11.95 ea.
A-17759-B	Bumper End Bolt Spacer. Steel. Black oxidized.		1928-31	.50 ea.
A-17759-SS	Stainless Steel Bumper Bolt Spacers.		1928-31	7.95 pr.
A-17762-AR	Round Center Bumper Medallion w/Backing Plate. Stamped "Ford Made in USA". 1926 to Early 1928.	1		10.95 ea.
A-17762-B	Round Center Bumper Medallion w/Backing Plate. Stamped Ford. 1928 to May 1929	1		12.95 ea.
 A-17762-BB	A-17762-BB Oval Center Bumper Medallion w/ Backing Plate & Polished Stainless Steel Cover.	1	5/'29-31	9.95 ea.
A-17766/67	Front Radiator Apron Bolt Set. (12 pcs.) To bolt apron to frame & bumper arms.	1	1930-31	9.95 set
A-17766/67-H	Front Radiator Apron Hex Bolt Set. Original style. (20 pc. set)	1	1930-31	18.95 set
 A-17777/78-D	A-17777/78-D Rear Bumper Braces with 5 " Body Stand. All Coupes, Cabriolets & Roadsters.	1	1928-31	199.95 pr.
A-17782-A	Rear Cross Brace Bolt Set. (14 pc. set)	1	1928-29	6.95 set
A-17782-B	Rear Cross Brace Bolt Set. (12 pc. set)	1	1930-31	5.95 set
A-17782-C	Rear Cross Brace Bolt Set. (12 pc. set)	1	Late '31	8.95 set
 A-17783-A	A-17783-A Tubular Rear Bumper Cross Brace. This is steel tube w/welded ends. Used '28 to early 1930.	1		56.95 ea.
 A-17783-E	A-17783-E Brace. Fits between rear bumper arms. Stamped steel.	1	1930-31	32.95 ea.





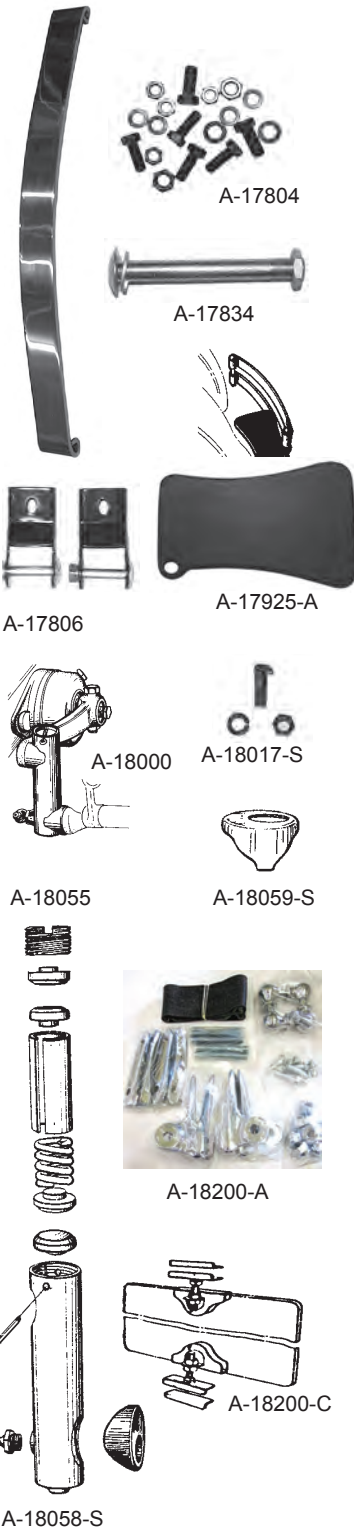





All prices listed in catalog subject to change. Call for current prices.

Part #	Description	Reqd.	Years	Price
<b>Bumpers</b>				
A-17784-DR	Rear Bumper Bars. (Less end bolts & spacers). Stainless steel.	1	1928-29	399.95 pr.
A-17785-E	Rear Bumper Bars. (Less end bolts & spacers). Stainless steel.	1	1930-31	389.95 pr.
A-17788	Rear Body Stand. 2 & 4 door Sedans. This 3" tall stand holds body to bumper arm.	2	1928-29	15.95 ea.
A-17789	Rear Body Stand. Sedan. This 4-1/2" stand holds body to bumper arm.	2	1930-31	15.95 ea.
A-17790	Rear Body Stand. Coupe & Roadster. This 5" stand holds body to bumper arm.	2	1928-31	15.95 ea.
A-17798	Rear Bumper Inside Brackets. Holds one end of rear bumper bar to rear bumper bracket.	1	1930-31	34.95 pr.
A-17802/3-D	Rear Bumper Braces with 4-1/2" Body Stand. Tudor Sedan.	1	1930-31	199.95 pr.
A-17804	Rear Bumper Arms to Frame Bolt Set. Black oxide. (18 pc. set)	1	1928-31	5.95 set
A-17806	Spare Tire Guard. Stainless steel. Complete with mounting hardware & brackets.	1	1930-31	118.95 ea.
A-17834	Bumper End Bolt w/Nut & Lock Washer. Plated.		1928-31	1.95 ea.
A-17836-SS	Bumper End Bolts & Nuts. Stainless steel.		1928-31	11.95 pr.
A-17925-A	Rear Bumper Gravel & Mud Guard.	1	1928-29	15.95 pr.
<b>Shock Absorbers</b>				
A-18000	Shock Absorber Set. Original style. USA.	1	1928-31	1,500.00 set
A-18000-M	Modern Tube Type Shock Kit. No major modifications required. All Hdwe. & Inst. Incl.		1928-31	329.95 kit
A-18010	Shock Arm Bolt Set. Special bolts for all four shock arms.	1	1928-31	4.95 set
A-18015-B	Shock Absorber. Made in USA. Fits right front or left rear.	1	1928-31	259.95 ea.
A-18016-B	Shock Absorber. Made In USA. Fits left front or right rear.	1	1928-31	259.95 ea.
A-18017-S	Shock Absorber Bolt & Nut Set. Special shoulder bolts to mount all four shocks.	1	1928-31	5.95 set
A-18047-B	Shock Arm. Front.	2	1928-31	29.95 ea.
A-18052-B	Shock Arm. Rear.	2	1928-31	29.95 ea.
A-18055	Tube Shock Link. Complete w/ internal parts.	4	1928-31	17.95 ea.
A-18055-B	Dogbone Style Shock Link.	4	1928-33	4.95 ea.
A-18058-S	Shock Link Grease Seals for Tubular Shock Links. (Set of 8)	1	1928-31	2.95 set
A-18059-S	Shock Link Grease Seal Caps for Tubular Link. Stamped steel. (Set of 8)	1	1928-31	4.95 set
A-18060-B	Rubber Bushing for Dogbone Style Shock Link. Fits links up to 1934.	8	1928-34	.75 ea.
<b>Accessories</b>				
A-18200-A	Windwing Bracket Set w/ Glass Pattern. Chromed. Open Car. (No glass)	1	1928-29	62.95 set
A-18200-B	Windwing Bracket Set w/ Glass Pattern. Chromed. Open Car. (No glass)	1	1930-34	72.95 set
A-18200-C	Windwing Brackets for Closed Car & Truck. Stainless steel. (No glass)	1	1920-32	72.95 set

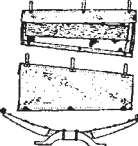

# Model A Parts

All prices listed in catalog subject to change. Call for current prices.

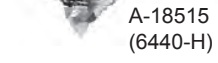
Part #	Description	Reqd.	Years	Price
<b>Accessories</b>				
 A-18300	A-18300 Traffic Light Finder. Authentic era accessory. Aids seeing those much needed traffic lights.	1	All years	18.95 ea.
	A-18300-D Deluxe Traffic Light Finder.	1	All years	17.95 ea.
	A-18300-M Magnetic Base for A-18300-D. (powerful magnet base) Chrome plated.	1	All years	7.95 ea.
	A-18350 Flag Holder with 3 Flags. Fits under motometer or under edge of hood behind meter. <b>A Great Parade Item!</b>	1		4.95 set
 A-18350	A-18350 -DLX Deluxe Stainless Steel 5 Flag Holder w/Flags.	1	All years	13.95 ea.
	A-18352-AR Wreath Rim Motometer & Locking Cap. Ford face. An original accessory. USA.	1	1928-29	69.95 ea.
	A-18352-B Wreath Rim Motometer & Locking Cap. Ford face. An original accessory. USA.	1	1930-31	69.95 ea.
 A-18385-B	A-18354-CW Wreath Rim Motometer, Chrome. Correct for Model A but will also fit Model T.	1	1909-31	52.95 ea.
 A-18352	A-18354-RK <b>NEW</b> Motometer Boyce Junior, Repair Kit. Chrome includes glass, gaskets and screws.			12.95 ea.
	A-18355 Motometer Cap Wings. Chrome plated. Fits between meter & cap.	1	1928-31	30.00 ea.
	A-18355-TQ Replacement Thermometer for Quail Radiator cap.	1	1928-31	19.95 ea.
 A-18400	A-18360-O <b>NEW</b> O Ring replaces original on hinged style radiator caps. As cap wears over time, this O Ring creates tight seal.			12.95 ea.
	A-18385-AR Flying Quail Radiator Cap. Original accessory. USA.	1	1928-29	125.00 ea.
 A-18422-B	A-18385-B Flying Quail Radiator Cap. Original accessory. USA.	1	1930-31	125.00 ea.
	A-18386-AR Thermo-Quail Radiator Cap. Combines the Flying Quail & Motometer on one cap.	1	1928-29	125.00 ea.
	A-18386-B Thermo-Quail Radiator Cap. Combines the Flying Quail & Motometer on one cap.	1	1930-31	125.00 ea.
	A-18387 Motometer Locking Cap Gasket Set. (2 pcs.)	1	1928-31	1.95 set
 A-18423	A-18400 Spring Cover Set. Fits both front & rear. An original accessory.	1	1928-31	26.95 set
 A-18424	A-18422-B Pedal Covers. Clutch & brake. Black rubber.	1	1928-31	3.95 pr.
	A-18422-S Deluxe Pedal Cover Set w/ Steel Rim. Fulton accessory.	1	1928-31	32.95 pr.
	A-18423 Vintage Style Flashlight. Chrome. Batteries not included.	1	All years	9.95 ea.
 A-18511	A-18424 Flashlight Holder. Used with A-18423. Will attach to most any round steering column.	1	1928-48	9.95 ea.
	A-18510 Exhaust Whistle. 4 tube <b>Aermore</b> style that sounds like a steam railroad train coming round the bend. <b>Great Parade Fun.</b> Requires A-18511 & A-18512 to operate your A.	1	1928-31	249.95 ea.
 A-18515	A-18511 Exhaust Whistle Valve. This unit connects A-18510 to your exhaust pipe. "A" is 1-3/4" dia.	1	1928-31	89.95 ea.
 A-18515 (6440-H)	A-18515 Hollywood Wolf Whistle. Die cast alloy "Hollywood" style vacuum whistle w/fittings & instructions. Operates on manifold vacuum.	1	1920-31	52.95 ea.



Part #	Description	Reqd.	Years	Price
<b>Accessories</b>				
A-18528	License Plate Frame. Chrome plated. Die cast. Script white on blue.	1	1928	8.95 ea.
A-18529	License Plate Frame, as above.	1	1929	8.95 ea.
A-18530	License Plate Frame, as above.	1	1930	8.95 ea.
A-18531	License Plate Frame, as above.	1	1931	8.95 ea.
A-18575-MB	<b>NEW</b> Luggage Rack Mounting Bolt Set.			6.95 ea.
A-18575-W	Luggage Rack w/ Wood Strips. Chrome plated.	1	1928-31	164.95 ea.
A-18576	Luggage Rack Adapter Brackets. Used to mount luggage rack to your car with rear mounted spare tire.	1	1928-29	10.95 pr.
A-18576-B	Luggage Rack Adapter Brackets. As above.		1930-31	9.95 pr.
A-18578	Luggage Rack Extender Brackets. This exact duplicate of an original accessory trunk rack mounting setup is used with rear spare in place. USA made of 1/4" steel. All Closed & Open Cars except 180-A & 400-A.	1	1928-31	59.95 pr.
A-18602	Luggage Carrier (Trunk). Black. Straight back. 34-1/2 L x 12-1/4 D x 20" high. Fits A-18575-C & W luggage racks.	1	1928-31	550.00 ea.
A-18603	Luggage Carrier (Trunk). Black. Fits A-18575-C & W luggage racks. Curved back to match rear contour of Sedans & Phaeton. 34-1/2 L x 12-1/4 D x 20" high.	1	1928-31	550.00 ea.
A-18650	Patent Data Plate w/ Rivets. Fits on passenger side of firewall under hood.	1	1928-31	1.50 ea.
A-18650-F	<b>NEW</b> Serial Number Plate with Ford Script.			6.95 ea.
A-18650-OP	Owners Plate. Owner's name and year car built can be engraved. Rivet to firewall.	1		5.95 ea.
A-18650-V	Vin Number Plate. Non original but frequently asked for.	1	All years	9.95 ea.
A-18651	Briggs Body Plate. Fits on firewall below A-18650. Briggs body.		1928-31	1.95 ea.
A-18652	Murray Body Plate. Brass w/rivets. Fits on firewall below A-18650. Murray Bodies.	1	1928-31	1.95 ea.
<b>Door Parts</b>				
A-19000	Door Pull. Fits on window molding of Cabriolet & Fordor Sedan.		1929-31	8.95 ea.
A-19001	Dovetails. Female. Stamped steel. 4 hole mounting. Fits 1929 & 1930-31 Cabriolet and 1929-31 Fordors, straight windshield.		1928-31	11.95 ea.
A-19002	Dovetails. Male. 2 hole mounting. Not off-set style. Used on rear doors of 1931 slant windshield Fordor Sedans.		1931	12.95 ea.
A-19003	Dovetail. Male. Nickle plated. 6 hole mounting. 60ABC/68AB/155ABCD/165ABCD/170AB		1928-31	9.95 ea.
A-19004	Door Striker Plate w/ Screws. Fordor & Town Sedan. 160-A-B-C. 1932-34 Closed Car & Pickup.		1931	8.50 ea.
A-19005	Sliding Door Lock Assembly w/ Screws. Coupe, Tudor Sedan & 1930-31 Pickup.	1	1928-31	3.95 ea.



A-18528

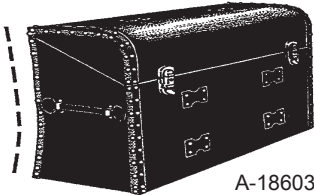

A-18603



A-18650-V



A-19001



A-19004

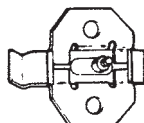

A-19005

# Model A Parts

All prices listed in catalog subject to change. Call for current prices.

Part #	Description	Reqd.	Years	Price
<b>Door Parts</b>				
A-19006	Door Striker Plate w/ Screws & Washers. 1928-31 Coupe & Tudor. Also 1930-31 PU.	2	1928-31	3.95 ea.
A-19006-B	Door Panel Bezel at Edge of Door. The half-moon bezel clamped to edge of upholstery opposite dovetail on door post. Stainless steel. Open and Closed Vehicle.	1	1928-31	1.50 ea.
A-19007	Dovetail. 2 hole Chrome plated. Fits Open Car, Coupe & Tudor Sedan.	1	1928-31	4.95 pr.
A-19007-S	Dovetail Mounting Screws. Open & Closed Vehicle. (Except 1928-29 Trucks) (set of 4)	1	1928-31	1.95 set
A-19008-A	Upper Door Seal at Belt Molding w/ Mounting Strips. 1928-31 Tudor, 1928-29 Coupe & 1930-31 Pickup.	1		15.95 pr.
A-19008-B	Upper Door Seal at Belt Molding w/ Mounting Strips. Coupe.	1	1930-31	15.95 pr.
A-19008-C	Upper Rear Window Seal at Belt Molding w/ Mounting Strips. Tudor.	1	1928-31	15.95 pr.
A-19009	Door Top Cover. Fits on top of door. 1928-29 Coupe & 1928-31 Tudor. Also 1930-31 Closed Cab.	2		63.00 ea.
A-19009-S	Door Top Cover Mounting Screw Set. Stainless. (6 pcs. - Enough for 2 doors)	1	1928-31	1.50 set
A-19010	Door Top Cover. Fits on top of door. Coupe.	2	1930-31	49.95 ea.
A-19011	Window Upper Rubber Seal. Fits in top of window frames. 1 per window. (Included in window channel kits).		1928-34	2.50 ea.
A-19012	Metal Glass Channel. Fits doors on Coupes, Tudors & 1930-31 Trucks.	2	1928-31	14.95 ea.
A-19013	Metal Glass Channel for Rear Window. Tudor Sedan.	2	1928-31	14.95 ea.
A-19014	Felt Glass Channel Strips w/ Mounting Clips & Rivets. Channel length 32". Not for 1928-29 Truck. (Included in window channel kits.)		1928-31	54.95 pr.
A-19015	Window Regulator Assembly. Right side. 3 hole mounting. For Coupe, Tudor Sedan & 1928-34 Closed Cab Truck.	1	1928-31	36.50 ea.
A-19015/6S	Window Regulator Mounting Screws & Star Washers. For 3 hole regulator. 1 set does both doors. Coupe, Tudor & Closed Cab Truck.	1	1926-31	1.50 set
A-19016	Window Regulator Assembly. Left side. 3 hole mounting. For Coupe, Tudor Sedan & 1928-34 Closed Cab Truck.	1	1928-31	36.50 ea.
A-19017	Window Glass Lower Bumper. Window glass rests on this when window is down. (Included in window channel kit.)		1928-36	.75 ea.
A-19018	Window Riser Main Spring.		1925-48	6.50 ea.
A-19019	Window Regulator Repair Kit. 5 tooth. This kit replaces the 5 tooth pinion gear/shaft that strips out after years of usage. (7pc. kit). Passenger Car & Closed Cab Truck.	1	1928-34	29.95 kit

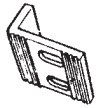

A-19006



A-19007



A-19009

A-19012



A-19013

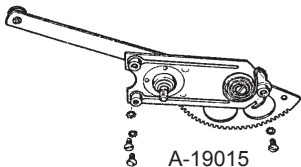

A-19015

Part #	Description	Reqd.	Years	Price
<b>Door Parts</b>				
A-19019-A	Window Regulator Repair Kit. 6 tooth. This kit replaces the 6 tooth pinion gear/shaft that strips out after years of usage. (7pc. kit). 1928-31 Pass. Car & 1928-34 Clsd. Cab Truck.	1	1928-34	12.95 ea.
A-19020	Door Header Strips Mounting Screw Set. Fits PL-18 & PL-20. (12 pc. set)	1	1928-31	2.95 set
A-19021	Window Channel Kit. All channels & clips for 2 Doors. 1924-27 Coupe & 1928-29 Pickup. (Does not include lower steel channel.)	1		84.95 kit
A-19022	Window Channel Kit. All channels & clips for 2 doors. (Does not include lower steel channel)			
	Coupe & Sport Coupe	1	1928-29	109.95 kit
	Tudor Sedan	1	1928-31	109.95 kit
	Closed Cab Truck	1	1930-31	109.95 kit
A-19024	Window Channel Kit. All channels & clips for 2 doors. Coupe & Sport Coupe. (Does not include lower steel channel).	1	1930-31	99.95 kit
A-19026	Window Channel Kit. All channels & clips for rear quarter windows in Tudor Sedan. (Does not include lower steel channel).	1	1928-31	54.95 kit
A-19028-L	Outside Door Handle. Fits left front or right rear. Cabriolet & Fordor.		1928-29	29.95 ea.
A-19029-R	Outside Door Handle. Fits right front or left rear. Cabriolet & Fordor.		1928-29	22.50 ea.
A-19030-L	Outside Door Handle. Left front or right rear. Cabriolet & Fordor. Also fits Victoria.		1930-31	29.95 ea.
A-19031-R	Outside Door Handle. Right front or left rear. Cabriolet & Fordor. Also fits Victoria.		1930-31	29.95 ea.
A-19031-RL	Scroll Locking Door Handle. Right front. Chrome. Includes 2 keys.		1930-31	43.95 ea.
A-19038	Window Regulator Assembly. Right side. 4 screw mounting. Fordor Sedan & Others.		1925-31	46.95 ea.
A-19039	Window Regulator Assembly. Left side. 4 screw mounting. Fordor Sedan & Others.		1925-31	46.95 ea.
A-19068	Window Garnish Molding Screw Set. Stainless steel. (8 pcs.)		1928-31	1.95 set
A-19070	Door Latch Wood covers. (included in body wood kit) Fits 1930-31 Coupe & Closed Cab Truck. Also 1928-31 Tudor Sedan.	1	1928-31	18.95 pr.
A-19071	Door Latch Assy. Right hand. Coupe & Tudor.	1	1928-29	32.95 ea.
A-19071-T	Door Latch, Right Hand. Closed Cab Pickup. (D-127/TK-10-A)	1	1928-29	124.95 ea.
A-19072-T	Door Latch, Left Hand. Closed Cab Pickup. (D-128/TK-11A)	1	1928-29	124.95 ea.
A-19072	Door Latch Assy. Left hand. Coupe & Tudor.	1	1928-29	36.95 ea.
A-19073	Door Latch Assy. Right hand. Coupe, Tudor & Closed Cab Pickup.	1	1930-31	32.95 ea.
A-19074	Door Latch Assembly. Left hand. Coupe, Tudor & Closed Cab Pickup.	1	1930-31	36.95 ea.
A19074-S	Door Latch Mounting Screw Set. (8 pcs. for 2 doors) 1928-31 Coupe & Tudor, 1930-31 Trucks.	1	1928-31	1.00 set

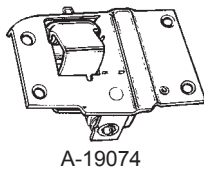
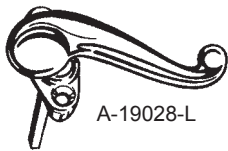

All prices listed in catalog subject to change. Call for current prices.

# Model A Parts

All prices listed in catalog subject to change. Call for current prices.

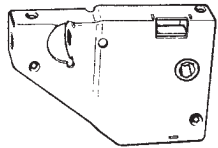

A-19075-B



A-19075-S



A-19076-AR



A-19076-B



A-19077

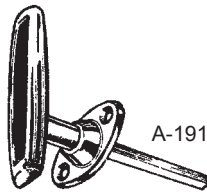

A-19100



A-19101



A-19101-D

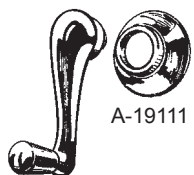

A-19102

Part #	Description	Reqd.	Years	Price
<b>Door Parts</b>				
A-19075-AR	Door Latch Assembly. With inside opener arm. Right hand. Open Car & Open Pickup.	1	1928	34.95 ea.
A-19075-B	Door Latch Assembly. Right hand. Roadster & Touring.	1	1929-31	17.95 ea.
A-19075-K	Door Latch Knob. 1928 Open Car and 1926-29 Closed Cab Truck.		1926-29	5.95 ea.
A-19075-S	Door Latch Screw Set. (8 pcs. set) Mounts door latches to both doors. Open Car & Pickup.	1	1928-31	1.25 set
A-19076-AR	Door Latch Assembly. With inside opener arm. Left hand. Open Car & Open Pickup.	1	1928	32.95 ea.
A-19076-B	Door Latch Assembly. Left hand. Open Car.	1	1929-31	19.95 ea.
A-19077	Door Striker Plate w/ Screws. Open Car & Truck.		1928-32	7.95 ea.
A-19079	Side Curtain Rod Socket. Open Car.		1930-36	8.95 ea.
A-19080	Door Hinge Screw Set w/ Special Washers for 1 Hinge.(6 pc. set) Closed Car.		1928-34	2.25 set
A-19085	Door Hinge Post Screw Set w/Nuts. For 1 door. Open Car.		1928-31	2.25 set
A-19086	Open Car Hinge Screws. Hinge to door.		1928-31	2.95 set
A-19088	Exterior Door Handle Screw Set. Stainless. For 2 metal framed doors.		1928-48	1.00 set
A-19090	Exterior Door Handle Screw Set. Stainless. For 2 wood framed doors. Stainless.		1926-36	1.00 set
A-19100	Outside Door Handle. Closed Car.	2	1926-29	29.95 ea.
A-19101	Inside Door Handle. Plain rounded end style w/ sleeve nut. All Coupes & Tudors.		'28-5/'30	11.95 ea.
A-19101-C	Inside Door Handle. Pointed nose style. Scroll type w/ sleeve nut. Briggs Fordor, Cabriolet & Town Car.		1928-29	9.95 ea.
A-19101-D	Inside Door Handle. Stub nose style. Scroll type w/ sleeve nut. All Coupe, Tudor & Closed Cab Truck, April 1930 to end. Also 1929-31 Murray Fordor & Town Sedan and 1930-31 Briggs Fordor.			12.95 ea.
A-19101-RC	Remote Door Latch Rods & Mounting Hardware. Links inside door handle to door latch. Fits both doors. Coupe.	1	1930-31	29.95 set
A-19101-RT	Remote Door Latch Rods & Mounting Hardware. Links inside door handle to door latch. Fits both doors. 1928-29 Coupe & Tudor. 1930-31 Tudor & Closed Truck.	1		29.95 set
A-19101-S	Door Handle Sleeve Nut Only.		1928-31	1.50 ea.
A-19101-V	Inside Door Handle. Pin style. Fits 1930-31 Victoria & Cabriolet, 1931 S/W Fordor Deluxe, 1931 S/W Town Sedan & A-400.		1930-31	8.95 ea.
A-19102	Window Riser Handle. Standard style. Used on Coupe, Tudor, Closed Cab Truck.		1924- mid '30	13.95 ea.

Part #	Description	Reqd. Years	Price
<b>Door Parts</b>			
A-19102-D	Window Riser Handle. Scroll style. All Coupes, Tudors, Closed Cab Trucks from April 1930-On. Standard Fordors. Some Murray and Briggs Town Sedans.	1930-31	11.50 ea.
A-19102-E	Window Riser Handle. Late 1931 Victoria A-400 & some Fordors & Slant W/S Sedans	1931	14.95 ea.
A-19102-D	A-19102-HP	Handle Pins. (set of 4) Solid steel pins for A-19101-V A-19102, A-19102-D. Also other handles thru 1948 except 1940.	.60 set
A-19102-R	Rear & Quarter Window Handle. Fits Slant Windshield Fordor & Coupe with roll down rear window.	1931	8.95 ea.
A-19103	Outside Door Handle. Open Car. Polished stainless steel as original	1928-33	22.50 ea.
A-19104-A	Outside Door Handle, Non-locking. Chromed. Closed Car.	1928-29	29.95 ea.
A-19104-B	Outside Door Handle. Non-locking. Chromed. Closed Car & Truck.	1930-31	29.95 ea.
A-19105	Outside Door Handle. Locking with 2 keys. Chrome. Coupe & Tudor.	1928-29	34.50 ea.
A-19107	Outside Door Handle. Locking with 2 keys. Chrome. Coupe, Tudor & Closed Cab Truck.	1930-31	39.95 ea.
A-19108	Door Lock & 2 Keys. Fits right side only. Closed Vehicle.	1924-48	13.95 ea.
A-19109	Rumble & Deck Lid Locking Handle with 2 Keys. Chromed.	1 1928-31	39.95 ea.
A-19109-N	Rumble & Deck Lid Handle Special Nut & Lockwasher Set.	1 1928-40	1.95 set
A-19109-P	Deck/Trunk Handle Pad w/ Formed Lip Edge. Fits between handle base & painted surface. Fits 1928-31 & 1933-34.	1 1928-37	2.25 ea.
A-19111	Escutcheon Plate. Spring loaded. Chrome plated. Round for window cranks.	1923-48	4.50 ea.
A-19112-R	Rubber Door Handle Pads w/ Formed Lip Edges. For 1928-34 Open Car & 1928-29 PU	1 1928-34	2.50 pr.
A-19113-R	Rubber Door Handle Pads w/ Formed Lip Edges. For 1928-34 Closed Car & 1930-36 Pickup.	1	2.50 pr.
A-19114	Window Handle Spring. Coned spring fits behind door panel to hold tension on the escutcheon plate.	1924-48	.50 ea.
A-19117-S	Door Spring Set. (7 pc. set) Does both front doors. Coupe, Tudor, PU (except 1928-29 Truck)	1928-31	4.95 set
A-19118	Door Hinge Pin. Open Car.	1928-31	.60 ea.
A-19119	Door Hinge Pin. Closed Car. 1-13/16" x 1/4".	1928-31	.60 ea.
A-19119-SL	Door Hinge Pin. Slant Windshield Car.	1931	.95 ea.
A-19119-SS	Door Hinge Pin. Stainless steel. Closed Car. 1-13/16" x 1/4".	1928-31	2.75 ea.
A-19120	Door Lock Knob. Sliding type. Coupe & Tudor.	1 1928-31	2.95 ea.

All prices listed in catalog subject to change. Call for current prices.

# Model A Parts

All prices listed in catalog subject to change. Call for current prices.

**Part # Description Req'd. Years Price**

## Door Parts



A-19121

A-19121 Door Lock Knob. Turn type w/ screw. Fordor Sedan & Cabriolet. 1928-31 5.95 ea.



A-19122-D

A-19122-D Deluxe Escutcheon Plate Set. (8 pcs.) Chromed brass. 1928-31 Coupe & 1930-31 Closed Cab Pickup 1 19.95 set

A-19122-S Standard Escutcheon Plate Set. Nickel plated. (8 pcs.) Coupe & Sport Coupe. 1 1928-30 20.95 set

A-19123-D Deluxe Escutcheon Plate Set. (10 pcs.) Chromed brass. Tudor Sedan. 1 1928-31 24.95 set

A-19123-S Standard Escutcheon Plate Set. Nickel plated. (10 pcs.) Tudor. Used 1928-Mid 1930. 1 26.95 set

A-19124-D Deluxe Escutcheon Plate Set. Chromed brass. Fordor Sedan. (12 pc. set) 1 1928-31 32.95 set

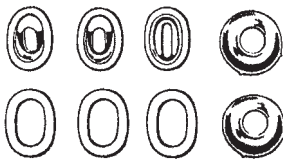

A-19122-S

A-19125 Inside Handle Escutcheon Plate. Stainless. Victoria, A400, Slant W/S Cars. Fits door & window handles. 1930-31 4.95 ea.

A-19128 Assist Strap Special Brackets. Bright nickel. 2 horizontal mounting holes. Tudor & Fordor Sedans except Slant Windshield Cars. 1 1928-31 8.95 pr.

A-19131 Footmans Loop for Door Strap, 1-1/4". Nickel plated. 1928-31 1.50 ea.

A-19131-C Footmans Loop Screw Set. Holds 4 loops A-19131 to two doors & door posts. Closed Car & Truck where used. 1 1925-29 1.95 set



A-19128

A-19131-S Door Check Screws. Fastens chrome plates thru leather straps to the doors & door posts. Stainless. (8 pcs.) Open Car & Truck. 1928-31 1.95 set

A-19134 **NEW** Door Sill Plates. 8" long. Script aluminum. Coupe. per pair. 1928-31 17.95 ea.

A-19133 Door Sill Scuff Screw Set. Stainless steel. (4 pcs.) (Requires 2 sets for A- 19135) 1926-31 .75 set



A-19134

A-19135 Door Sill Plates. 19-5/8" long. Script aluminum. Tudor Sedan. 1 1928-31 29.95 pr.

A-19136 Door Sill Scuff Plates. These have the cross-hatched etched design w/Ford script. 1 1930-31 62.95 pr.

A-19140 Landau Arm Nut. Stainless. Cabriolet. 4 1928-31 9.95 ea.

## Floorboards

Floor Boards Made of Exterior Grade Plywood. All Openings Pre-Cut and Drilled. Ready to Paint and Install.



A-19140

A-19192 Center Rear Floorboard. 7 ply birch hardwood veneer. Tudor Sedan. 1 1928-31 56.95 ea.

A-19193 Rear Floorboard. 7 ply birch hardwood veneer. Tudor Sedan only. 1 1928-29 67.95 ea.

A-19194 Rear Floorboard. 7 ply birch hardwood veneer. Tudor Sedan only. 1 1930-31 67.95 ea.

A-19195 Rear Floorboard Screws & Washers. Black oxide. (36 pcs.) Tudor Sedan. 1 1928-31 3.50 set

A-19196 Rear Floorboard Woven Seal Kit. Special Woven material for center and/or rear floorboard with tacks. (2 kits per car) 1 1928-31 5.95 kit

**Part # Description Req'd. Years Price**

## Floorboards

Floor Boards Made of Exterior Grade Plywood. All Openings Pre-Cut and Drilled. Ready to Paint and Install.

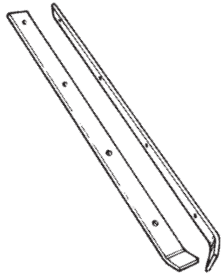

A-19202

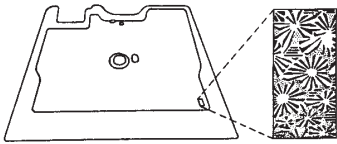

A-19207

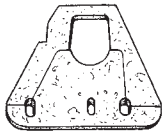

A-19211

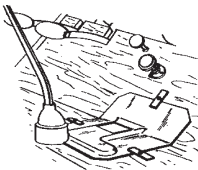

A-19215-AR

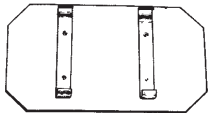

A-19217



A-19230



A-19401

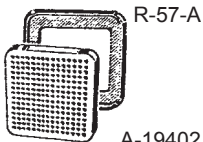

R-57-A

A-19402

A-19200	Front Floorboards. To fit All Body Styles. Brake handle in front. 1928 thru early 1929.	1		89.95 set
A-19201	Front Floorboards. To Fit All Body Styles. Brake handle on right. Late 1929 thru 1931.	1		89.95 set
A-19202	Floorboard Reinforcement Irons. USA. Powder coated black with special rivets.	1	1928-31	11.95 pr.
A-19204	Front Floorboard Screw & Washer Set. Black oxide finish. (24 pc. set)	1	1928-31	2.95 set
A-19205	Front Floorboard Woven Seal Kit. Special woven material that is tacked to edges of both front floorboards. Includes tacks & instructions.	1	1928-31	3.50 kit
A-19206	Front Floor Mat. Black rubber. Brake to front. Authentic design.	1	1928-29	65.00 ea.
A-19207	Front Floor Mat. Black rubber. Brake to right. Authentic design. Used late 1929-1931			74.95 ea.
A-19208	Rear Floor Mat. Black rubber. Tudor Sedan.	1	1930-31	72.95 ea.
A-19208-A	Rear Floor Mat. Black Rubber. Tudor Sedan.	1	1928-31	72.95 ea.
A-19209	Rumble Seat Floor Mat. Black rubber. Coupe, Cabriolet & Roadster.	1	1928-31	42.95 ea.
A-19211	Steering Post Felt Pad. Fits under metal floor board plate set.	1	1928-31	1.50 ea.
A-19212	Floorboard Steering Column & Pedal Plate Set. Covers A-19211 felt pad. Black powder coated.	1	1929-31	6.95 set
A-19212-B	Mounting Screw Set for Floorboard Column Plate.	1	1928-31	1.95 set
A-19214	Transmission Floorboard Plate Hold Down Clips w/ Special Rivets. (6 pcs.)	1	1928-31	4.95 set
A-19215-AR	Transmission Cover Plate. Brake-in-front. Black powder coated steel.	1	1928-29	5.95 ea.
A-19215-D	Transmission Cover Plate. Brake-to-right. Black powder coated steel.	1	1929-31	7.95 ea.
A-19216	Battery Cover Plate for Floorboards. 4-1/8" wide.	1	1928	6.95 ea.
A-19217	Battery Cover Plate for Floorboards. 5-1/4" wide.	1	1929-31	6.95 ea.
A-19230	Manifold Heater Assembly. With firewall valve to control heat. Bolts onto the exhaust manifold.	1	1928-31	89.95 ea.

## Rumble Seat

A-19400	Roadster Top Rest or Rumble Seat Grab Rails w/ Mounting Hardware. Polished stainless.	1	1928-32	39.50 pr.
A-19401	Rumble Grab Handle Inner Braces. Stamped steel braces go under area that grab rails bolt to for reinforcement.	1	1928-32	27.95 pr.
A-19402	Step Plate for Rear Fender or Bumper. Square aluminum. 1928 to Mid 1929	2		6.95 ea.

All prices listed in catalog subject to change. Call for current prices.

# Model A Parts

All prices listed in catalog subject to change. Call for current prices.

A-19403-A



R-57



A-19405

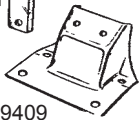

A-19409  
(part of set)



A-19411



A-19412-S

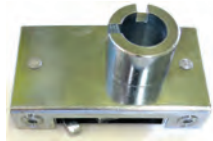

A-19414-B

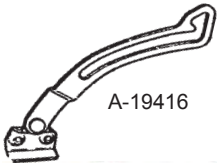

A-19416



A-19418



A-19509-OR



A-19510



A-19511

Part #	Description	Reqd.	Years	Price
<b>Rumble Seat</b>				
A-19403-A	Step Plate for Rear Fender or Bumper w/ Mounting Bolts. Round polished aluminum. Mid 1929 thru 1931.	2		6.95 ea.
A-19405	Rear Step Plate Bracket. Ductile. Fits on rear bumper brace.	1	1929-31	7.95 ea.
A-19407	Rumble Lid. (Less mounting hardware) Stamped steel. Coupe & Roadster.	1	1928-29	625.00 ea.
A-19407-T	Trunk Lid. (Less mounting hardware) Stamped steel. Coupe & Roadster.	1	1928-29	625.00 ea.
A-19408	Rumble Lid. (Less mounting hardware) Stamped steel. Coupe & Roadster.	1	1930-31	625.00 ea.
A-19408-T	Trunk Lid. (Less mounting hardware) Stamped steel. Coupe & Roadster.	1	1930-31	625.00 ea.
A-19409	Rumble Lid Lower Stop Bracket Set w/Bolts & Rubber Bumpers. Die formed steel.	1	1928-29	16.95 set
A-19410	Rumble Lid Lower Stop Bracket Set w/Bolts & Rubber Bumpers. Die formed steel.	1	1930-31	16.95 ea.
A-19411	Rumble Lid Latch Bracket w/ Mtg. Hardware.	1	1928-32	1.95 set
A-19412-S	Rumble Lid Hinge Set. Complete with all brackets & bolts.	1	1928-31	69.95 set
A-19413	Rumble Lid Hinge Mounting Bolt Set. Special shoulder bolts & washers for rumble seat hinge pivot & screws to mount deck lid to hinges.	1	1928-32	5.95 set
A-19414-A	Rumble Lid Latch Assembly. 1" tall. (Also fits 1928-34 trunk lid).	1	1928-29	15.95 ea.
A-19414-B	Rumble Lid Latch Assembly. 1-1/2" tall.	1	1930-34	11.95 ea.
A-19415	Trunk Latch Striker Plate. For non-rumble seat cars.	1	1928-31	6.50 ea.
A-19416	Trunk Lid Support Arm. Coupe, Roadster & Cabriolet.	1	1928-32	16.95 ea.
A-19416-SB	Trunk Lid Arm Mounting Bolt Set. This 5 pc. set fastens the trunk lid support arm to the drain trough on Coupe, Cabriolet & Roadster. Instructions included. USA.	1	1928-32	3.50 set
A-19418	Trunk Lid Hinge Set. Special shoulder bolts and mounting plates to attach trunk lid to upper drain trough area.	1	1928-32	22.95 set
<b>Nut &amp; Bolt Sets</b>				
A-19508	Cotter Pin Set. Cadmium plated steel. Correct sizes w/ list of locations included. (160 pcs.)	1	1928-31	6.50 set
A-19508-S	Cotter Pin Set. Stainless steel. Correct sizes with list of locations included. (160 pcs.)	1	1928-31	16.95 set
A-19509	Modern Style Zerk Fitting Set. Plated. (36 pc. set).	1	1928-31	8.95 set
A-19509-OR	Original Style Grease Fitting Set. All the correct sizes needed. (32 pc. Set)	1	1928-31	12.95 set
A-19510	Grease Gun Adapter. To adapt original fittings to modern grease gun.	1	1928-31	3.95 ea.
A-19511	Grease Fitting Installation Driver. Used to install original drive-in style fittings.	1	1928-31	3.95 ea.
A-19513	Running Board Mounting Bolt & Nut Set. Bolts boards to stamped steel brackets. (24 pcs.)	1	1929-31	10.95 set



Part #	Description	Reqd.	Years	Price
<b>Nut &amp; Bolt Sets</b>				
A-19514	Body to Frame Bolt Set. Plated. (36 pcs.)	1	1928-31	7.95 set
A-19514/0	Body to Frame Bolt Set. Contains correct size, type & length bolts w/ instructions. (42 pc. set). Tudor Sedan.	1	1928-29	11.95 set
A-19514/1	Body to Frame Bolt Set. Contains correct size, type & length bolts w/ instructions. (34 pc. set). Tudor Sedan.	1	1930-31	11.95 set
A-19514/2	Body to Frame Bolt Set. As above. (42 pc. set). Coupe.	1	1928-29	11.95 set
A-19514/3	Body to Frame Bolt Set. As above. (34 pc. set). Coupe.	1	1930-31	12.50 set
A-19514/4	Body to Frame Bolt Set. As above. (54 pc. set). Fordor & Town Sedan.	1	1928-29	8.95 set
A-19514/5A	Body to Frame Bolt Set. As above. (50 pc. set). Deluxe Fordor & Town Sedan.	1	1930-31	10.95 set
A-19514/5B	Body to Frame Bolt Set. As above. (48 pc. set). Standard Fordor & Town Sedan.	1	1930-31	10.95 set
A-19514/6	Body to Frame Bolt Set. As above. (48 pc. set). Roadster.	1	1928-29	9.95 set
A-19514/7	Body to Frame Bolt Set. As above. (40 pc. set). Roadster.	1	1930-31	18.95 set
A-19515	Fender Bolt Set. (182 pcs.)	1	1928-29	16.95 set
A-19516	Fender Bolt Set. Correct bolts for 2 piece splash aprons. (106 pcs.)	1	1930	16.50 set
A-19517	Fender Bolt Set. Correct bolts for 1 piece splash aprons. (178 pcs.)	1	1931	17.95 set
A-19528	Oil Can Mounting Bracket.		1909-32	7.95 ea.
<b>Headers &amp; Top Wood</b>				
A-19561	Header. For all Coupes & Tudor Sedans including 130-A Deluxe Delivery.	1	1928-29	129.95 ea.
A-19562	Header. All Closed Cab Trucks. Model 82-A, A & AA.	1	1928-29	119.95 ea.
A-19565	Header. Coupe 45-B & Sport Coupe 50-B.	1	1930-31	169.95 ea.
A-19566	Header. Tudor Sedan 55-B & Closed Cab Truck 82-B including Deluxe Delivery 130-B and all Steel Top Pickup 66-A.	1	1930-31	169.95 ea.
A-19567	Header. Victoria 190-A & Slant Windshield Fordor 160-A, B, C.	1	1930-31	159.95 ea.
A-19568	Header. Murray Fordor Sedan 155-C, 165-C.	1	1930-31	199.95 ea.
A-19742	Body Wood Kit. Includes belt rail and seat back wood. Roadster.	1	1928-29	234.95 kit
A-19747	Body Wood Kit. 45-A Coupe. Kiln dried ash. All the body shell area less the top wood.	1	1928-29	489.95 kit
A-19748	Top Wood Kit. 45-A Coupe. All the wood above the doors including the header.	1	1928-29	500.00 kit
A-19749	Body Wood Kit. 55-A Tudor Sedan. Kiln dried ash. All the body shell area less top wood.	1	1928-29	460.00 kit
A-19749-R	Body Wood. Includes belt rail & seat back wood for 40-B. Roadster.	1	1930-31	204.95 ea.
A-19750	Top Wood Kit. 55-A Tudor Sedan. All the wood needed above doors, including the header and top wood corners.	1	1928-29	605.00 kit



A-19513



A-19528



A-19751-MK

All prices listed in catalog subject to change. Call for current prices.

# Model A Parts

All prices listed in catalog subject to change. Call for current prices.



A-19755



A-19805

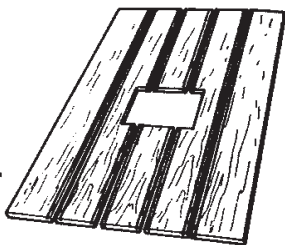

TK-89  
(A-19810)

Part #	Description	Reqd.	Years	Price
<b>Headers Body &amp; Top Wood</b>				
A-19750-MK	Top Wood Mounting Kit. Tudor Sedan. Provides all hardware to mount top wood to steel body. (411 pcs.)		1928-29	29.95 kit
A-19751	Body Wood Kit. 45-B Coupe. Kiln dried ash. All the body shell area less the top wood.	1	1930-31	500.00 kit
A-19751-MK	Body Wood Mounting Kit. Coupe. Provides all hardware to mount body wood to steel body. (212 pcs.)		1930-31	13.95 kit
A-19752	Top Wood Kit. Oak. 45-B Coupe. All the wood needed above the doors including the header.	1	1930-31	489.95 kit
A-19752-MK	Top Wood Mounting Kit. Coupe. Provides all hardware to mount top wood to steel top. (226 pcs)		1930-31	23.95 kit
A-19753	Body Wood Kit. 55-B Tudor Sedan. Kiln dried ash. All the body shell area less top wood.	1	1930-31	424.95 kit
A-19754	Top Wood Kit. Oak. 55-B Tudor Sedan. All the wood needed above the doors including the header & top wood corners.	1	1930-31	644.95 set
A-19754-HB	Header Steel Brackets. Laser cut. Connects the wood header to the wood top side rails. Fits Closed Cab Truck mid-1930-31 & Tudor Sedan.	1	1930-31	49.95 pr.
A-19754-HBS	Header Brackets Screw Set. (20 pcs.) Fastens steel header brackets to wood header and side top rail. Mid 1930-31 Closed Cab Truck. Tudor	1	1930-31	2.95 set
A-19754-MK	Top Wood Mounting Kit. Tudor Sedan. Provides all hardware to mount top wood to steel body. (188 pcs.)		1930-31	23.95 kit
A-19755	Top Wood Corners for Tudor Sedan. The rear upper corner wood where the roof molding is tacked in place.	1	1928-31	81.50 pr.
A-19756	Nails for body/trim. (100 per bag)		All years	2.25 bag
A-19756-SS	Nails for body/trim. Stainless. (100 per bag)		All years	2.95 bag
<b>Body Mounting Parts</b>				
A-19801	Body Mounting Blocks. Oak w/ rubber mounting pads. Coupe & Roadster. (12 pcs.)	1	1928-29	57.95 set
A-19802	Body Mounting Blocks. Oak w/ rubber mounting pads. Phaeton. (10 pcs.)	1	1928-29	57.95 set
A-19803	Body Mounting Blocks. Oak w/ rubber mounting pads. Tudor Sedan. (7 pcs.)	1	1928-29	64.95 set
A-19804	Body Mounting Blocks. Oak w/ rubber mounting pads. Tudor Sedan. (7 pcs.)	1	1930-31	69.95 set
A-19805	Body Mounting Blocks. Oak w/ rubber mounting pads. Coupe & Roadster. (12 pcs.)	1	1930-31	61.95 set
A-19807	Body Mounting Blocks. Oak w/ rubber mounting pads. Fordor Phaeton. (10 pcs.)	1	1930-31	61.95 set
A-19808	Body Mounting Blocks. Oak w/ rubber mounting pads. A& AA Clo. Cab Truck. (6 pcs)	1	1928-29	49.95 set
A-19809	Body Mounting Blocks. Oak w/ rubber mtg. pads. A& AA Closed Cab Truck. (6 pcs.)	1	1930-31	49.95 set
A-19810	Bed Wood Set. Hardwood. Standard Bed Pickup.	1	1928-31	362.95 set
A-19812	Body Wood. Including belt rail & seat back wood. Model 76-A, Open Cab Truck, A & AA.	1	1928-29	209.95 set
A-19814	Cab Wood. Including door posts & seat back wood. Model 82-A, Closed Cab Truck, A & AA.	1	1928-29	289.95 set

Part #	Description	Reqd.	Years	Price
<b>Body Mounting Parts</b>				
A-19816	Top Wood. All the wood above the doors including the header. A & AA Closed Cab Truck, Model 82-A.	1	1928-29	489.95 set
A-19816-MK	Pickup Top Wood Mounting Kit. Provides all hardware to mount top wood to Closed Cab Truck (72 pcs.)	1	1928-29	8.95 kit
A-19817	Cab Wood & Seat Back Wood for Closed Cab Truck, A & AA. Model 82-B.	1	1930-31	232.95 set
A-19817-S	Top Wood 1931 ALL STEEL TOP. All the wood above the doors including the header	1	1931	359.95 set
A-19818	Top Wood. All the wood above the doors including the header. A & AA Closed Cab Truck, Model 82-B.	1	1930-31	450.00 set
A-19818-HB	Header Steel Brackets. Laser cut. Connects wood header to top wood side rails. Closed Cab Truck.	1	1930-31	49.95 pr.
A-19818-MK	Pickup Top Wood Mounting Kit. Provides all hardware to mount top wood to Closed Cab Truck. (255 pcs.)	1	1930-31	19.95 kit
A-19820	Pickup Bed Mounting Blocks. Two large blocks holding bed to frame. All holes drilled as original. Includes tail light mounting block. (Set of 3 pcs.)	1	1928-31	119.95 set
<b>Model A Rubber Parts Door Rubber Bumper Sets</b>				
R-1	Door Bumper Set. Coupe, Tudor, Sport Coupe & Cabriolet. (set of 10 pcs.)	1	1928-29	7.95 set
R-1-A	Door Bumper Set. Coupe, Tudor, Sport Coupe & Closed Cab Truck. (set of 10 pcs.)	1	1930-31	7.95 set
R-2	Door Bumper Set. All Briggs & Murray Fordor Sedans. (set of 20 pcs.)	1	1928-31	11.95 set
R-4	Door Bumper Set. Roadster & Roadster Pickup. (set of 12 pcs.)	1	1928-29	7.95 set
R-4-A	Door Bumper Set. Roadster, Roadster Pickup & Tudor Phaeton. (set of 12 pcs.)	1	1930-31	8.95 set
R-5	Door Bumper Set. Cabriolet. No Slant Windshield. (set of 10 pcs.)	1	1930-31	7.95 set
R-6	Door Bumper Set. Phaeton. (set of 24 pcs.)	1	1928-29	17.95 set
R-6-A	Door Bumper Set. Phaeton. (set of 24 pcs.)	1	1930-31	12.95 set
R-7	Door Bumper Set. Closed Cab Pickup. (12 pcs.)	1	1928-29	7.95 set
R-8	Door Bumper Set. Slant Windshield, Fordor. (set of 16 pcs.)	1	1931	15.95 set
R-12	Door Bottom T Rubber. Fits bottom of doors. Takes 1 set for Roadster & 2 sets for Phaeton.		1928-31	3.95 set
R-13	Door Bottom H Rubber. Fits bottom of Closed Car & Truck. (Takes 2 sets for Fordor Sedan)		1928-31	5.50 set
R-15	Rear Window Rubber Bumpers w/ Screws. Used when top is down. Open Car. (4 pcs.)	1	1928-31	3.95 set
R-43	Trunk Lid Bumper Set. The 2 bumpers at the lower corners of the trunk lid.	1	1928-34	2.50 set
R-44	Rumble Lid Bumper Set. The rubber stops for rumble lid conversions. (set of 4)	1	1928-39	4.95 set



R-1-A



R-7



R-15



R-44

All prices listed in catalog subject to change. Call for current prices.

# Model A Parts

All prices listed in catalog subject to change. Call for current prices.

Part #	Description	Reqd.	Years	Price
<b>Model A Rubber Parts Door Straps</b>				
R-57	Mounting Pad for Step Plate on Fender. Round rubber. Gives a snug fit to A-19403-A.	1	1930-31	1.50 ea.
R-57-A	Mounting Pad for Step Plate on Fender. Square rubber. Gives a snug fit to A-19402-A.	1	1928-29	1.95 ea.
R-80	Front Windshield Rubber. For 1926-31 Closed Car & 1928-34 Closed Cab Truck.	1		4.95 set
R-81	Header Rubber. Fits at upper hinge. 1928-31 Closed Car & 1932-34 Pickup.			3.95 set
R-82	Windshield Glass Setting Material. Authentic cloth backed rubberized cork glass bedding to set the glass in the windshield frame. 3/64" thick. 20 ft roll. Closed vehicles.		1928-31	9.95 roll
R-83	Front Windshield Rubber Set. Open Car.	1	1928-29	4.95 set
R-83-A	Front Windshield Rubber Set. Open Car.	1	1930-36	4.95 set
R-84	Rear (Back) Window Rubber. 1928-36 Closed Car. (Also 1928-34 Comm.)			5.95 set
R-85	Quarter & Rear Window Rubber. For both windows. Coupe.	1	1928-41	8.95 set
R-88	Door Check Strap. 6" loop type. For any 'A' with side mounted spare.		1928-34	3.95 ea.
R-89	Door Check Strap. 7" loop type. For most trucks w/ plain fenders.		1928-34	2.95 ea.
R-90	Door Check Strap. 8" loop type. For any Coupe, Tudor w/ plain fenders.		1928-34	5.50 ea.
R-92	Door Check Strap. 10-1/2" T head style. Used on many types of 'A' & V-8 Fords. Fordor, rear doors.			7.50 ea.
R-93	Rubber Stops for Metal Door Check Arms.		1928-36	1.50 pr.
R-94	Door Check Arms. Steel w/rubber stops. Coupe, Sedan & Commercial.	1	1928-48	5.50 pr.
R-94-B	Check Arm Internal Bracket. Bracket is spot welded to door to hold R-94. Order 1 set per door. Closed Vehicle.		1928-31	5.95 set
R-96	Leather Door Check Straps with Screws & Brackets. Roadster, Phaeton, Roadster PU.		1928-34	29.95 set
<b>Model A Sheet Metal Replacement Parts</b>				
PA-1	Inner Curved Panel. In rear of rumble seat with 4 grooves like original. 1928-31 Roadster & 1930-31 Coupe.	1		103.95 ea
PA-2	Inner Rear Panel. For Standard Roadster & Coupe without rumble seat.	1	1928-31	84.95 ea.
PB-1	Platform Section. Original design. Rumble cushion rests on this.	1	1928-31	124.95 ea.
PB-4	Rumble Hinge Braces. Hinges bolt to this. Coupe & Roadster. 17-1/4" to floor.	1	1928-29	68.95 pr.
PB-5	Rumble Hinge Braces. Hinges bolt to this. Coupe & Roadster. 18-1/4" to floor.	1	1930-31	68.95 pr.
PB-7	Inner Triangular Corner Plates in Trunk or Rumble Compartment. Coupe & Roadster.	1	1928-31	99.95 pr.
PB-8	Trunk or Rumble Front Braces. Rain gutters to fender panel front braces. Coupe, 23-1/2" to floor. Roadster, 22-1/2" to floor.	1	1928-29	68.95 pr.

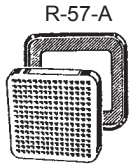

R-57-A



R-83-A

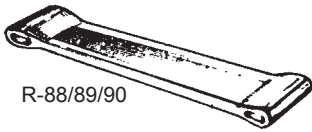

R-88/89/90



R-92

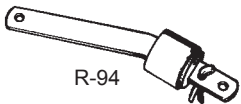

R-94



R-96



PA-1

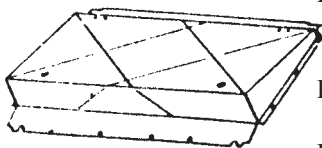









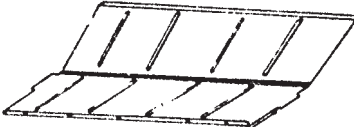
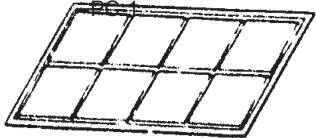

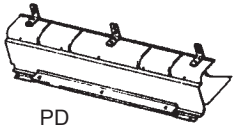

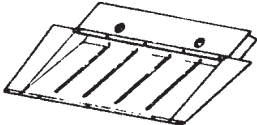
PB-1

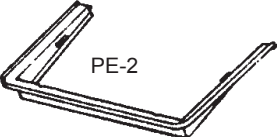

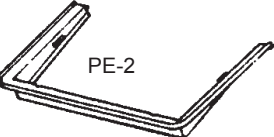
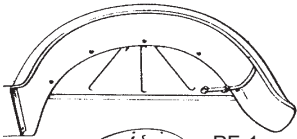
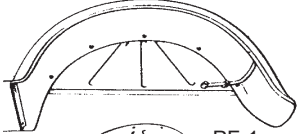
PB-7



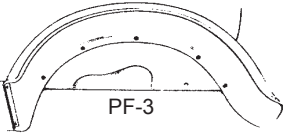
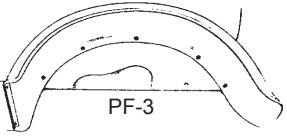
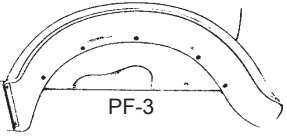
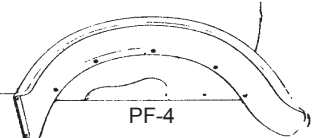
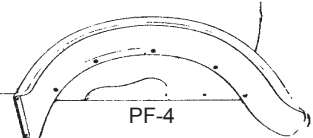
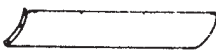
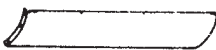
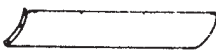





## Model A Sheet Metal Replacement Parts

	Part #	Description	Reqd.	Years	Price
	PB-9	Trunk or Rumble Front Braces.	1	1930-31	68.95 pr.
	PC-1	Floor Pan in Trunk or Rumble Area. Angled floor. Fits 1928-29 Coupes & All 1928-31 Roadsters.	1		124.95 ea.
	PC-2	Floor Panel. Fits in trunk or rumble area. Flat floor. Die stamped. (Ribs face up). Coupe Only.	1	1930-31	99.95 ea.
	PC-3	Floor Pan. Cabriolet 68B. Has 4 sides with 3 turned up edges. Slant Windshield only. USA.	1	1930-31	69.95 ea.
	PC-4	Floor Pan Under Seat. Die stamped steel. Closed Cab Truck.	1	1928-29	64.95 ea.
	PC-4-B	Floor Pan Under Seat. Die stamped steel. Closed Cab Truck.	1	1930-31	68.95 ea.
	PC-5	Floor Pan Under Front Seat. For Cabriolet, 68-C; S/W Fordor; Late 1931 Coupe. 11 - 1/2 x 27-1/2 x 2-1/2 deep. (X design).	1	1930-31	69.95 ea.
	PC-6	Panel Under Front Seat Platform. Die stamped steel. Coupe.	1	1930-31	98.95 ea.
	PC-7	Panel Under Rear Seat Frame. (Less floor hump) Tudor Sedan.	1	1928-29	84.95 ea.
	PC-8	Panel Under Rear Seat Frame. (Less floor hump) Tudor Sedan.	1	1930-31	84.95 ea.
	PC-9	Rear Hump over Crossmember. Tudor & Fordor Sedan.	1	1928-31	105.00 ea.
	PD	Riser. Backrest spring fits on this item. Roadster & Coupe.	1	1930-31	98.95 ea.
	PD-1	Riser. Backrest spring fits on this item. Roadster & Coupe.	1	1928-29	98.95 ea.
	PD-2	Riser. Backrest spring fits on this item. Sport Coupe & Cabriolet.	1	1930-31	69.95 ea.
	PE-1	Curtain Pan Under Front Seat. Roadster & Touring.	1	1928-31	104.95 ea.
	PE-2	Front Seat Platform for Front Cushion. Roadster & Touring. (Not for Roadster Pickup).	1	1928-29	104.95 ea.
	PE-3	Front Seat Platform for Front Cushion. Standard Coupe, Sport Coupe & Cabriolet.	1	1928-29	104.95 ea.
	PE-4	Front Seat Platform for Front Cushion. Roadster & Touring. (Not for Roadster Pickup).	1	1930-31	114.95 ea.
	PE-5	Front Seat Platform for Front Cushion. Attaches to seat assembly. Holds front cushion. Coupe.	1	1930-31	99.95 ea.
	PF-1	Rear Inner Fender Panels. Die formed. Roadster.	1	1928-31	72.95 pr.
	PF-2	Rear Inner Fender Panels. Die formed. Cabriolet & Coupe.	1	1928-31	89.95 pr.
	PF-3	Rear Inner Fender Panels. Die formed. Fordor Sedan, Briggs & Murray.	1	1928-31	72.95 pr.
	PF-4	Rear Inner Fender Panels. Die formed. Tudor Sedan.	1	1928-31	89.95 pr.
	PG				

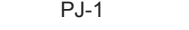
All prices listed in catalog subject to change. Call for current prices.

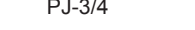
# Model A Parts

All prices listed in catalog subject to change. Call for current prices.

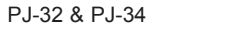
Part #	Description	Reqd.	Years	Price
<b>Model A Sheet Metal Replacement Parts</b>				
 PH	PG-1 Outside Rear Panel. Fits below rumble or trunk lid. High panel 9-1/2". Roadster.	1	1928-29	74.95 ea.
	PG-2 Outside Rear Panel. Fits below rumble or trunk lid. Low panel 7-3/4". Coupe & Sport Coupe.	1	1928-29	74.95 ea.
 PH-8	PH Outside Rear Panel. Fits below rumble or trunk lid molding at bottom. High panel, 9 1/4" Roadster & Coupe.	1	1930-31	89.95 ea.
	PH-1 Panel Above Rumble Lid. Roadster only. A-19400 fits this. (Will not do for Coupe)	1	1928-29	239.95 ea.
 PH-2	PH-2 Panel Above Rumble Lid. Roadster only. A-19400 fits this. (Will not do for Coupes)	1	1930-31	239.95 ea.
 PJ-1	PH-5 Panel Above Windshield - Under Visor. Coupe & Tudor Sedan.	1	1928-29	99.95 ea.
	PH-6 Panel Under Sun Visor. Town Sedan & Fordor Sedan.	1	1928-29	69.95 ea.
 PH-8	PH-8 Panel Under Sun Visor. Coupe & Fordor, except Slant Windshield.	1	1930-31	79.95 ea.
	PH-9 Panel Under Sun Visor. Tudor Sedan & Closed Cab Truck.	1	1930-31	89.95 ea.
 PJ-3/4	PJ-1 Front Quarter Patch Panels. Die formed. Right & left.	1	1930-31	22.50 pr.
 PJ-2	PJ-2 Front Quarter Patch Panels. Fits from gas tank down to frame. Fits all except Fordor Sedans & Cabriolets.	1	1928-29	199.95 pr.
 PJ-10	PJ-3 Rear Quarter Patch Panels. Coupe, Cabriolet & Sport Coupe.	1	1928-29	36.95 pr.
	PJ-4 Rear Quarter Patch Panels. Tudor Sedan.	1	1928-29	26.95 pr.
	PJ-5 Rear Quarter Patch Panels. Roadster.	1	1928-29	34.95 pr.
	PJ-6 Rear Quarter Patch Panel. Roadster Pickup. Stamped Steel.	1	1928-29	82.95 pr.
 PJ-8	PJ-8 Rear Quarter Patch Panels. Coupe.	1	1930-31	79.95 pr.
	PJ-10 Rear Quarter Patch Panels. Tudor.	1	1930-31	27.95 pr.
 PJ-10-Q	PJ-10-Q <b>NEW</b> Sedan Rear Quarter Patch Panels.	1	1930-31	74.95 pr.
	PJ-12 Rear Quarter Patch Panels. Roadster.	1	1930-31	27.95 pr.
	PJ-15 Rear Lower Body Patch Panel. Repairs rusted out area of Tudor Sedan. 48"x5".	1	1928-29	36.95 ea.
	PJ-16 Rear Corner Patch Panels. Die stamped steel. Coupe, Roadster, & Sport Coupe.	1	1928-29	34.95 pr.
	PJ-17 Rear Corner Patch Panels. Die stamped steel. Coupe & Roadster.	1	1930-31	42.00 pr.
	PJ-18 Rear Corner Patch Panels. Tudor Sedan & Fordor Phaeton.	1	1930-31	34.95 pr.
	PJ-19 Rear Lower Body Patch Panel. Tudor Sedan. This rear lower body patch panel w/ beaded contour. Repairs rusted out area. 48"x5".	1	1930-31	62.95 ea.
	PJ-32 Rear Quarter Patch Panels. Tudor Sedan.	1	1932	34.95 pr.
	PJ-33 Front Quarter Patch Panels. Die stamped.	1	1933-34	27.50 pr.
	PJ-34 Rear Quarter Patch Panels. Tudor Sedan.	1	1933-34	34.95 pr.
	PK Body Cross Channels. Floor pans are fastened to these channels. Open & Closed Vehicles (Except 1930-31 Coupe) (3 pc. set)	1	1928-31	94.95 set

Part #	Description	Reqd.	Years	Price
<b>Model A Sheet Metal Replacement Parts</b>				
PK-1	Body Cross Channels. (3 pc.set) Floor pans are fastened to these channels. Coupe only.	1	1930-31	94.95 set
PK-10	Outer Rear Crossmember. Coupe & Roadster.	1	1928-31	235.00 ea.
PK-11	Outer Rear Crossmember. Tudor Sedan.		1928-31	214.50 ea.
PL-CC	Closed Cab Pickup Door Skins.		1928-29	199.95 pr.
PL-1	Door Bottom Patch Panels. Cpe. & Sport Cpe.	1	1928-29	29.95 pr.
PL-2	Door Bottom Patch Panels. Coupe.	1	1930-31	78.95 pr.
PL-3	Door Bottom Patch Panels. Roadster & Roadster Pickup.	1	1928-29	59.95 pr.
PL-4	Door Bottom Patch Panels. Roadster.	1	1930-31	42.95 pr.
PL-5	Door Bottom Patch Panels. Tudor Sedan and Closed Cab Pickup.	1	1930-31	89.95 pr.
PL-6	Door Bottom Patch Panels. Tudor Sedan.	1	1928-29	29.95 pr.
PL-7	Door Bottom Patch Panels. 33-3/4" long x 6" high. Fits 1931 Victoria & A-400.	1	1931	49.95 pr.
PL-7A	Door Bottom Inner Patch Panels. Victoria & A400.		1930-31	44.95 pr.
PL-8	Door Garnish Moldings. 26-15/16" long. Coupe & Tudor Sedan.	1	1928-29	129.95 pr.
PL-10	Door Garnish Moldings. 26" long. Coupe.	1	1930-31	129.95 pr.
PL-11	Door Garnish Moldings. 27-7/16" long. Tudor & Pickup Truck.	1	1930-31	129.95 pr.
PL-12	Rear Side Window Garnish Moldings. 37" long. Tudor.	1	1928-31	129.95 pr.
PL-15	Door Bottom Inner Patch Panels. Coupe and Tudor Sedan.	1	1928-29	42.95 pr.
PL-16	Door Bottom Inner Patch Panels. Coupe.	1	1930-31	37.50 pr.
PL-17	Door Bottom Inner Patch Panels. Tudor & Closed Cab Truck.	1	1930-31	49.95 pr.
PL-18	Door Header Strips. Fits above doors on body 28-1/8" long. All bodies except 1930-31 Coupes & Fordors.	1	1928-31	74.95 pr.
PL-20	Door Header Strips. Fits above doors on body. 27" long. Coupe.	1	1930-31	29.95 pr.
PL-29	Window Felt Retainer Channel. Holds felt in place. It is spot welded to edge of door, 16-1/2" overall length. Fits hinge side of right door & lock side of left door w/ rivet to attach bottom. All Coupes & Tudor Sedans.	1	1928-29	9.95 ea.
PL-29L	Window Felt Retainer Channel as above. Fits hinge side of left door & lock side of right door w/ rivet for bottom. All Coupes & Tudor Sedans.	1	1928-29	9.95 ea.
PL-30	Window Felt Retainer Channel as above. Fits hinge side of right or left door w/ rivet to attach bottom. Mid 1930-31 Truck & Tudor Sedan.	1	1930-31	10.95 ea.
PL-30LL	Window Felt Retainer Channel as above. Fits lock side of left door w/ rivet to attach bottom. Mid 1930-31 Truck & Tudor Sedan.	1	1930-31	10.95 ea.
PL-30LR	Window Felt Retainer Channel as above. Fits lock side of right door w/ rivet to attach bottom. Mid 1930-31 Truck & Tudor Sedan.	1	1930-31	10.95 ea.



PL-2



PL-8

All prices listed in catalog subject to change. Call for current prices.

# Model A Parts

All prices listed in catalog subject to change. Call for current prices.

Part #	Description	Reqd.	Years	Price
<b>Model A Sheet Metal Replacement Parts</b>				
PL-31HL	Window Felt Retainer Channel as above. Fits hinge side left door w/ rivet to attach bottom. All Coupes.	1	1930-31	10.95 ea.
PL-31HR	Window Felt Retainer Channel as above. Fits hinge side right door w/ rivet to attach bottom. All Coupes.	1	1930-31	10.95 ea.
PL-31LL	Window Felt Retainer Channel as above. Fits lock side left door w/ rivet to attach bottom. All Coupes.	1	1930-31	10.95 ea.
PL-31LR	Window Felt Retainer Channel as above. Fits lock side right door w/ rivet to attach bottom. All Coupes.	1	1930-31	10.95 ea.
PV-29	Sun Visor. Coupe & Sedan.	1	1928-29	99.95 ea.

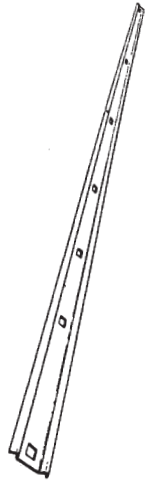

TK-1

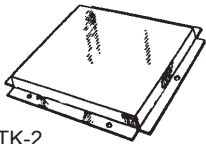

TK-2



TK-5



TK-7



TK-8

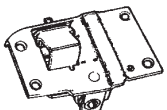

TK-11



TK-12-WF

## Truck Parts

Gaslight's Truck Section is designed with the truck restorer in mind. Although many parts fit Passenger Cars as well as Trucks, this section will showcase those parts that are identified with Ford Trucks from 1926-52.

TK-1	Metal Bed Strips. Die stamped. (Set of 4) Pickup Truck. (Not for Wide Bed)	1	1928-31	89.95 set
TK-2	Center Bed Plate. Pickup Truck.	1	1928-31	29.95 ea.
TK-3	Dispatch Pocket w/Mounting Hardware. Also used for maps, etc. Fits on pass. side kick panel.	1	1930-34	22.95 ea.
TK-4	Rear Quarter Patch Panels. Roadster Pickup.	1	1928-29	22.95 pr.
TK-5	Pickup Cab Rear Corner Patch Panels.	1	1930-31	37.95 pr.
TK-6	Lower Panel at Rear of Cab. 48" wide. Beaded edge. A & AA Closed Cab Truck.	1	1930-31	62.95 ea.
TK-7	Door Bumper Set. Roadster Pickup. (12 pcs.)	1	1928-29	7.95 set
TK-8	Door Bumper Set. Closed Cab Truck. (10 pcs.)	1	1928-29	7.95 set
TK-9	Door Bumper Set. Closed Cab PU. (10 pcs.)	1	1930-31	7.95 set
TK-9-A	Door Bumper Set. Roadster Pickup. (12 pcs.)	1	1930-31	8.95 set
TK-10	Door Latch Assembly. Right hand. Closed Cab Truck.	1	1930-31	24.95 ea.
TK-10-A	Door Latch. Right hand. Closed Cab Pickup. (A-19071-A / D-127)	1	1928-29	119.95 ea.
TK-11	Door Latch Assembly. Left hand. Closed Cab Truck.	1	1930-31	29.95 ea.
TK-11-A	Door Latch. Left hand. Closed Cab Pickup. (A-19072-A / D-128)	1	1928-29	119.95 ea.
TK-12	Door Garnish Moldings. 27-3/8" long. Closed Cab Truck. (Use A-19068 stainless steel screw set)	1	1928-29	124.95 pr.
TK-12-A	Door Top Cover. Closed Cab Truck.	2	1930-31	57.95 ea.
TK-12-P	Door Lever Anti-Rattler Pads. Fits TK-12.	1	1928-29	3.50 pr.
TK-12-WF	Inside Door Window Frames w/Brackets & Fittings. Closed Cab Truck.	1	1926-29	134.95 pr.
TK-13	Door Garnish Molding. 27-7/16" long. Closed Cab Pickup.	1	1930-31	104.95 pr.
TK-13-A	Upper Door Seal at Belt Molding w/Mounting Strips. Pickup.	1	1930-31	12.95 pr.
TK-14	Window Channel Kit. All channels & clips for 2 doors. Pickup Truck.	1	1926-29	84.95 kit



Part #	Description	Reqd.	Years	Price
<b>Truck Parts</b>				
TK-14-A	Window Channel Kit. All channels & clips for 2 doors. Closed Cab Truck.	1	1930-31	109.95 kit
TK-15	Window Regulator Assy. Right side. 3 hole mounting. Closed Cab Truck.	1	1928-34	36.50 ea.
TK-16	Window Regulator Assy. Left side. 3 hole mounting. Closed Cab Truck.	1	1928-34	36.50 ea.
TK-16-A	Metal Glass Channel for Doors.	2	1928-31	14.95 ea.
TK-17	Door Bottom Patch Panels. A & AA Truck.	1	1928-29	89.95 pr.
TK-17-A	Door Bottom Inner Patch Panels. A & AA Closed Cab Truck.	1	1928-29	37.95 pr.
TK-18	Door Bottom Patch Panels. Closed Cab Truck.	1	1930-31	89.95 pr.
TK-18-A	Door Bottom Inner Patch Panel. Closed Cab Truck.	1	1930-31	49.95 pr.
TK-19	Seat Bottom Cushion Frame for Roadster Pickup Only.		1928-29	94.95 ea.
TK-19-A	Floor Pan Under the Seat Frame for Roadster Pickup Only.		1928-29	64.95 ea.
TK-20	Floor Pan Under Seat. Die stamped steel. Closed Cab Truck.	1	1928-29	64.95 ea.
TK-20-B	Floor Pan Under Seat. Die stamped steel. Closed Cab Truck.	1	1930-31	68.95 ea.
TK-21	Seat Platform for Bottom Cushion. Closed Cab Pickup.	1	1928-29	105.00 ea.
TK-22	Seat Platform for Bottom Cushion. Closed Cab Pickup	1	1930-31	94.95 ea.
TK-25	Seat Riser Support at Back of Cab on Floor. (Often called rear cab cross member).	1	1930-31	84.95 ea.
TK-27	Pickup Bed Panel Between Cab & Bed. Open & Closed Cab.	1	1928-31	48.95 ea.
TK-28	Pickup Bed Front Panel w/Top Corner Brackets. Standard Bed Pickup.	1	1928-31	150.00 ea.
TK-29	Rain Gutters. Stamped steel w/ inserts & fasteners, 30- 3/4" long. Closed Cab Pickup.	1	1928-29	38.50 pr.
TK-29-HD	Hinge to Door Hardware. Screws and star washers to fasten three hinges to one door. Closed Cab Truck.	1	1928-29	2.95 set
TK-29-HP	Hinge to Door Post Hardware. Screws and square nuts to fasten three hinges to one door post. Closed Cab Truck.	1	1928-29	2.95 set
TK-29RK	Door Latch Repair Kit. Contains all springs, screws & rivets needed to repair both door latches. Closed Cab Truck.	1	1926-29	15.95 kit
TK-30	Rain Gutters. Stamped steel w/ fabric insert & fasteners, 31-3/4" long. Closed Cab Pickup.	1	1930-31	36.50 pr.
TK-31	Outside Door Handle. Closed Cab Pickup.	2	1926-29	29.95 ea.
TK-32	Inside Door Opener w/ Sleeve Nut. Closed Cab.		1930-31	12.95 ea.
TK-33	Window Riser Handle. Standard style. Used on Closed Cab Truck.		mid '24- mid '30	10.95 ea.
TK-33-D	Window Riser Handle. Scroll style. Closed Cab Truck. June 1930-31		1930-31	10.95 ea.
TK-34	Door Handle. Non-locking. Chromed. Closed.	1	1930-31	29.95 ea.
TK-35	Door Handle. Locking. Chromed. Closed.	1	1930-31	39.95 ea.
TK-36	Sun Visor Framework. Closed Cab Pickup.	1	1928-29	98.95 ea.

All prices listed in catalog subject to change. Call for current prices.

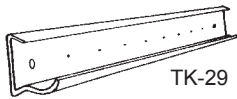

TK-29

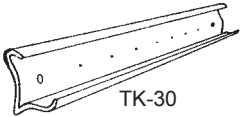

TK-30

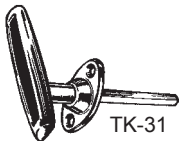

TK-31



TK-32



TK-33

# Model A Parts

**Part # Description Req'd. Years Price**

## Truck Parts

Gaslight's Truck Section is designed with the truck restorer in mind. Although many parts fit Passenger Cars as well as Trucks, this section will showcase those parts that are identified with Ford Trucks from 1926-52.

TK-36-C	Sun Visor Kit. Cobra long grain material. Matches the top material for a trim appearance of the visor. Closed Cab Truck.	1	1928-29	29.95 kit
TK-37	Sun Visor Kit. Cobra long grain material. Outside Wiper Arm. Black. Closed Cab Pickup.	1	1928-31	6.95 ea.
TK-38	Outside Mirror. Painted black. Mounts on door post. Closed Cab Truck.	1	1928-29	29.50 ea.
TK-38-H	Outside Mirror. Hinge type. Closed Cab Truck.	1	1930-31	34.95 ea.
TK-39	Panel Under the Sun Visor. Closed Cab Truck.	1	1928-29	99.95 ea.
TK-40	Panel Under the Sun Visor. Closed Cab Truck.	1	1930-31	89.95 ea.
TK-42	Inside Rear Window Frame with Hardware. Closed Cab Truck.	1	1928-29	31.95 ea.
TK-43	Inside Rear Window Frame. This authentic stamping is from a Ford print. Closed Cab.	1	6/30-34	79.50 ea.
TK-44	Rear Window Frame Corner Brackets. Used to attach the rear window frame to the Closed Cab Truck. (4 pc. set).	1	1930-31	22.50 set
TK-45	Mud Shield for Tail Lamp Wiring. This shield fits at rear of T/L & protects wiring from mud.	1	1929-48	4.95 ea.
TK-46	Drum Tail Lamp Bracket. Malleable iron casting. Pickup, Panel & Bus.	1	1928-29	14.95 ea.
TK-47	Pickup Tail Lamp Bracket for A-13405-SL. 1929-30 & 1929-31 AA Truck. (Also V-8 Pickup thru 1937). Now SS.	1		18.95 ea.
TK-48	Tail Lamp Bracket. Fits Commercial Vehicles 1930-31 Panel & Deluxe Pickup Deluxe and Special Deliveries.	1	1929-31	13.95 ea.
TK-49	Oak Block. For tail lamp bracket. Pickup. Used for mounting T/L bracket under side of left rear pickup box. Includes 6 pc. mounting bolt set.	1	1928-31	4.50 ea.
TK-50	Door Striker Plate w/ Mounting Hardware. Fits on door post. (2 pc. set). Closed Cab Truck.	2	1928-29	12.95 ea.
TK-50-S	Door Striker Shield Plate. Nails to door post to hold weather stripping. (4 nails included) Closed Cab Truck	2	1928-29	6.25 ea.
TK-51	Female Dovetail. 4 hole type. Stamped steel with mounting hardware. Fits on door post. Closed Cab Truck.	2	1928-29	9.95 ea.
TK-52	Male Dovetails. 4 hole. Chrome plated. Closed Cab Truck.	1	1928-29	4.95 pr.
TK-53	Door Striker Plate w/Mounting Screws & Washers. Closed Cab Truck.	2	1930-31	3.95 ea.
TK-53-A	Dovetails. 2 hole Chrome plated. Closed Cab Truck.	1	Late'30-31	4.50 pr.
TK-54	Pickup Bed Bolt & Washer Set.	1	1928-31	14.95 set
TK-55	Tailgate Chain Hook. Authentic gauge & shape. <b>State Year:</b> 1926-37 or 1938-52.	2		5.25 ea.
TK-56	Tailgate Hook Retainer Springs.	1	1938-50	8.25 pr.



TK-43



TK-53



TK-55

All prices listed in catalog subject to change. Call for current prices.

## Part # Description Req'd. Years Price

### Truck Parts

Gaslight's Truck Section is designed with the truck restorer in mind. Although many parts fit Passenger Cars as well as Trucks, this section will showcase those parts that are identified with Ford Trucks from 1926-52.



TK-62



TK-67

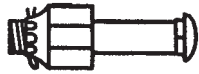

TK-70



TK-72

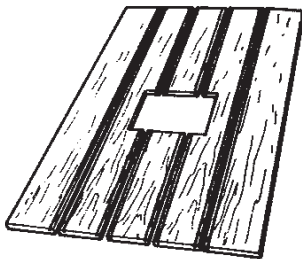

TK-89

TK-57	Tailgate Chain. Authentic gauge. (16 links) <i>State Year:</i> 1926-31 & 1931-37.	2		3.75 ea.
TK-58	Tailgate Chain. Authentic gauge & style links. (13 links)	2	1938-52	4.25 ea.
TK-60	Tailgate Chain Cover. Black. Authentic grained material.	2	1926-37	3.95 ea.
TK-62	Tailgate Chain Top Link. Rolled iron. Must be welded to fit.	2	1926-37	2.95 ea.
TK-63	Tailgate Chain Top Link. Must be welded to fit cast steel.	2	1938-50	9.95 ea.
TK-64	Tailgate Chain Bracket. Stamped steel. Rivets to Pickup box sides. <i>State year</i> 1926-31 & 1931-37.	2		8.25 ea.
TK-65	Tailgate Chain Bracket. Stamped steel. Rivets to Pickup box sides.	2	1938-50	5.95 ea.
TK-67	Tailgate Hinges. Stamped steel. Drilled and ready to mount. Std. Bed Pickup. ( set of 2)	1	1926-31	16.50 set
TK-68	Tailgate Hinge Set. Stamped steel hinges. Drilled & ready to mount. Wide Bed Truck. (Set of 3)	1	1931-36	13.95 set
TK-70	Tailgate Hinge Bolt w/Nut & Pin. Special design bolt that fits TK-67 hinge.	2	1926-31	5.50 ea.
TK-72	Bed Spacers. Fender to bed. Stamped steel. Fastens to bed sides.	1	1928-31	195.00 pr.
TK-74	Z-Brackets. Bed sills to frame. Pickup. (Holds TK-94 to subframe)	1	1928-31	69.95 pr.
TK-79	Pickup Wagon Box Rivet Set. (set of 4)	1	1926-39	.95 set
TK-81	Pickup Round Head Rivets for Bed Center Plate & Fender Spacers. (set of 4)	1	1928-31	.95 set
TK-82	Cab to Frame Bolt Set. Proper mounting bolts w/ instructions. Open or Closed Cab.	1	1928-29	32.95 set
TK-83	Cab to Frame Bolt Set. Proper mounting bolts w/ instructions. Open or Closed Cab.	1	1930-31	22.95 set
TK-84	Pickup Box to Frame Bolt Set. Proper mounting bolts w/ instructions. Std. Bed Only. (22 pcs.)	1	1928-31	8.95 set
TK-85	Header. All Closed Cab Truck Model 82-A, A & AA.	1	1928-29	92.95 ea.
TK-86	Header. Closed Cab Truck 82-B Including Deluxe Delivery 130-B & all Steel Top Pickup 66-A.	1	1930-31	169.95 ea.
TK-87	Body Mounting Blocks w/Rubber Mounting Pads. A & AA Closed Cab Truck.	1	1928-29	49.95 set
TK-88	Body Mounting Blocks w/Rubber Mounting Pads. A & AA Closed Cab Truck.	1	1930-31	49.95 set
TK-89	Bed Wood Set. Hardwood. Standard Bed Pickup.	1	1928-31	362.95 set
TK-90	Body Wood. Includes door posts & seat back wood. Model 76-A, A & AA. Open Cab Truck.	1	1928-29	209.95 set

All prices listed in catalog subject to change. Call for current prices.

# Model A Parts

All prices listed in catalog subject to change. Call for current prices.

Part #	Description	Reqd.	Years	Price
<b>Truck Parts</b>				
TK-91	Cab Wood. Body wood including door posts & seat back wood. A & AA Closed Cab Truck. Model 82-A.	1	1928-29	289.95 set
TK-92	Top Wood. All the wood above the doors including the header. A & AA Closed Cab Truck. Model 82-A.	1	1928-29	489.95 set
TK-92-T	Cab Wood & Seat Back Wood for Closed Cab Truck. A & AA. Model 82-B.	1	1930-31	232.95 set
TK-93	Top Wood. All the wood above the doors including the header. Closed Cab Truck. A & AA. Model 82-B.	1	1930-31	450.00 set
TK-93-HB	Header Steel Brackets. Laser cut. Connects wood header to wood top side rails. Closed Cab Truck.	1	1930-31	49.95 pr.
TK-93-RB	Truck Roof Rail Bracket. Closed Cab. The 'T' shaped bracket connects top wood side rail to top of door post. Includes hardware. (14 pcs.) A & AA Truck. USA.	2	mid '30-1931	12.95 ea.
TK-93-T	Top Covering Kit. Includes black long grain top material, black lining, hide 'um welt tacks, sealant & complete instructions. Closed Cab Truck. <i>Specify Year.</i>	1	1928-31	132.00 kit
TK-94	Pickup Bed Mounting Blocks. 2 large blocks holding bed to frame. All holes drilled as original. Includes tail light mounting block. (3 pc. set)	1	1928-31	119.95 set
TK-95	Tailgate w/ Hinges. Script as original. Standard Bed 41-1/2" wide. (Other years available).		1929-31	299.95 ea.
TK-98	Pickup Bed Sides. Die stamped steel for Model A Pickup Truck. No mounting hardware.	1	1928-31	595.95 pr.
TK-100	Pickup Truck Bed Assembly. Complete. Fully assembled w/ script tailgate. Unpainted. (Crating - \$250.00 extra)	1	1928-31	1,695.00 ea.

## Trim Sets

First quality oval head screws, nuts, & washers. Everything for the interior of the car. Exacting attention is paid to these sets to provide a pleasing appearance.

Description	Sets Fitting 1928-29	Sets Fitting 1930-31
Roadster	TR-10 ..... 7.95 set	TR-20 ..... 7.95 set
Roadster Pickup	TR-11 ..... 7.95 set	TR-21 ..... 7.95 set
Coupe	TR-12 ..... 9.95 set	TR-22 ..... 9.95 set
Tudor Sedan	TR-13 ..... 10.95 set	TR-23 ..... 11.00 set
Closed Cab Trucks	TR-14 ..... 10.95 set	TR-24 ..... 9.95 set
Sport Coupe	TR-15 ..... 9.95 set	TR-25 ..... 9.95 set
Briggs Fordor	TR-16 ..... 18.95 set	TR-26 ..... 22.95 set
Murray Fordor	TR-17 ..... 18.95 set	TR-27 ..... 18.95 set
Phaeton (Touring)	TR-18 ..... 9.95 set	TR-28 ..... 7.95 set
Oval Speedometer Dash	TR-30 ..... 1.25 set	
Round Speedometer Dash		TR-31 ..... 3.95 set
Dash Rail, Stainless Steel	TR-35 ..... 2.95 set	TR-35 ..... 2.95 set



TR-10



TR-23

Part #	Description	Reqd. Years	Price
--------	-------------	-------------	-------

## Trim Sets

First quality oval head screws, nuts, & washers. Everything for the interior of the car. Exacting attention is paid to these sets to provide a pleasing appearance.

Description	Sets Fitting 1928-29	Sets Fitting 1930-31
Radiator Apron to Frame & Bumper Arm Bolts	TR-37 ..... 2.50 set	TR-38 ..... 2.50 set
Front Fenders to Frame		TR-40 ..... 2.50 set

## Model A Extras

<b>A-HAT</b>	Adjustable Ford Baseball Hat	10.00 ea.
<b>A-LUBE</b>	<b>Lubrication Chart.</b> Heavy Glossy Poster 17" X 22" with mounting holes ready to hang. Ideal for mounting in your work area. Detail is excellent.	7.50 ea.
<b>A-WP</b>	<b>Model A Ford Poster</b> Has 40 original factory photos of various body styles as well as the memorable 'A' front view. Heavy glossy paper. 25" x 34"	6.95 ea.
<b>A-WPFF</b>	<b>Fabulous Fords Wall Poster.</b> Has 69 original factory photos from Henry's first vehicle in 1896 to the great 1940 Ford. Heavy glossy paper. 25" x 37"	6.95 ea.
<b>A-WPPP</b>	<b>NEW Model A Power Plant Wall Poster.</b>	12.00 ea.
<b>FORD-HAT</b>	Adjustable Ford Baseball Hat	8.95 ea.
<b>HP-A</b>	<b>Model A Hat Pin</b>	7.95 ea.
<b>HP-27</b>	<b>Hat Pin/Quail Cap</b>	8.95 ea.

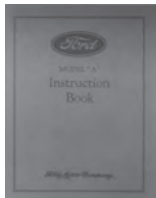
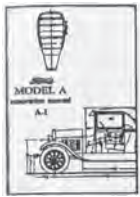
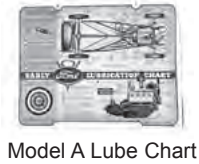

AB-1

AB-3A

AB-3/30

AB-5

## Model A Books

<b>AB-AQ</b>	<b>The Cars That Henry Ford Built</b> A commemorative tribute to America's most remembered automobiles. Contains over 100 full color pictures. Covers 1903 Model A thru 1941 Model 11A. 136 pages.	19.95 ea.
<b>AB-1</b>	<b>Model A Restoration Manual 1928-31</b> Contains basic information to acquaint you with data in all respects to the Model A. 72 pages, 29 illustrations & photos.	11.95 ea.
<b>AB-2</b>	<b>Model A and AA Parts Price List</b> Late 1931 printing. 84 Pages.	9.95 ea.
<b>AB-3</b>	<b>Model A Instruction Book. 1928.</b> Maintenance & repair. 52 pages and 31 illustrations It came with the vehicle.	14.95 ea.
<b>AB-3A</b>	<b>Model A Instruction Book. Late 1931.</b> General maintenance & simple repairs, including AA Truck info. 50 pages with 32 illustration. It came with the vehicle.	14.95 ea.
<b>AB-3/29</b>	<b>Model A Instruction Book. 1929</b> The instruction book provided with the 1929 Model A. This offers many illustrations. 50 pages..	13.95 ea.
<b>AB-3/30</b>	<b>Model A Instruction Book. 1930</b> The instruction book provided with the 1930 Model A. This offers many illustrations. 50 pages.	13.95 ea.
<b>AB-5</b>	<b>Model A Body Parts List—A &amp; AA 1928-31</b> Lengthy listing of all body parts offered when the Model A was being built. No exploded view of body parts. 251 pages.	22.95 ea.

# Model A Parts

All prices listed in catalog subject to change. Call for c

Part #	Description	Reqd. Years	Price
<b>Model A Ford Books</b>			
AB-6	<b>Model A Construction, Operation &amp; Repair the Restorer</b> One of the best books by Victor Page on the Model A Ford, its construction, operation and repair. Many pictures.		35.95 ea.
AB-7	<b>Model A Miseries and Cures</b> Not a technical or authentic restoration manual. A book for the Ford owner who takes pleasure in driving his car and keeping it in good running condition. 225 pages.		29.95 ea.
AB-8	<b>Model A Passenger Car &amp; Model AA Truck Engine/Chassis Manual</b> A Dyke's reprint on the Model A. 40 pages, 64 illustrations.		11.95 ea.
AB-9	<b>Model A Album</b> Photos of most body styles built. Includes charts, articles, parts and accessories. 143 pages. 50 photographs.		23.95 ea.
AB-11	<b>Model A Service Bulletins</b> A compilation of the factory bulletins as supplied to the dealers. 320 pages, 500 illustrations. Hardbound.		32.95 ea.
AB-12	<b>The Ford Model A As Henry Built It</b> A wealth of positive information drawn from the Ford archives for the enthusiasts.		39.95 ea.
AB-13	<b>Model A Restoration &amp; Maintenance Handbook: Volume # 1</b> 58 pages, 73 illustrations.		11.95 ea.
AB-14	<b>Model A Restoration &amp; Maintenance Handbook: Volume #2</b> 59 pages, 115 illustrations.		14.95 ea.
AB-15	<b>The Model A Ford Carburetors</b> A history of the various styles including rebuilding, testing, and operation. 40 pages. 53 illustrations.		12.95 ea.
AB-16-T	<b>Tillotson Carburetors Repair &amp; Restoration 1928-31</b> Spiral bound w/over 50 illustrations.		19.95 ea.
AB-17	<b>Model A Ford Restoration Handbook</b> A book for the novice providing valuable input towards restoration of the 'A'. 160 pages. 42 photos. 64 illustrations.		22.95 ea.
AB-18	<b>Antique Ford Repaint Manual 1928-1936</b> Complete color chip guide to authentic colors for the Fords. 16 pages, 55 illustrations & 30 photographs.		26.95 ea.
AB-19	<b>Henry's Fabulous Model A</b> A large book full of interesting information on the Model A. 111 pages, 96 photographs & 20 illustrations.		21.95 ea.
AB-20	<b>Restoring the Model A Ford Pickup</b> A well illustrated book with over 85 pictures and 50 pages offering more pickup information than any other book.		23.95 ea.
AB-21	<b>AA Truck Shop Manual</b> By author Jim Shields. Informative and useful in AA restoration.		21.95 ea.
AB-22	<b>Model A/AA Ford Truck Owner</b> Adapted from a large 1930 sales document. Contains 500 illustrations of commercial vehicles. 228 pages. Hardbound.		29.95 ea.
AB-23	<b>Those Wonderful Unauthorized Accessories</b> Most of the accessories both obscure & familiar have been assembled in this absorbing book of items available during the A's sales years. 256 pages, 450 illustrations. Softbound.		22.95 ea.

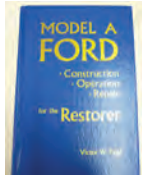

AB-6



AB-7



AB-8



AB-9



AB-11



AB-16



AB-16-T



AB-18



AB-19



AB-20



AB-21



AB-23

All prices listed in catalog subject to change. Call for current prices.

Part #	Description	Reqd. Years	Price
<b>Model A Ford Books</b>			
AB-24	<b>Matchless Model A</b> Take a step back to the assembly line when the product was the Model A. 64 pages, 150 photos.		11.95 ea.
AB-25	<b>Gem From the River Rouge</b> A detailed and non-technical book on the operation and history of this famous Ford factory. Hardbound.		21.00 ea.
AB-26	<b>Restoring the Open Model A</b> This 72 page book covers all 4 years & all body styles. Backed up with factory details & photos of original cars.		23.95 ea.
AB-27	<b>Shop Kinks and Tools</b> This pocket size book gives an insight into the tools of the time. Used on Model A, B & V-8's. Electrical and many other hints. 84 illustrations. 45 pages.		4.95 ea.
AB-28	<b>Improved Features of the New Ford</b> This compact booklet provides general information about then new 1930-31 Fords. 12 photographs. 18 pages.		3.95 ea.
AB-29	<b>The Model A Generator and Starter</b> Complete restoration manual on Model A & B generators & starters including Powerhouse & Abell. 60 pages & over 50 pictures.		17.95 ea.
AB-30	<b>Model A Coupes</b> Practical information about 1930-31 Coupes. Well illustrated and informative data on this popular body style. 175 pages.		32.95 ea.
AB-32	<b>Model A Ford Mechanics Handbook</b> 425 page book with over 500 illustrations dealing with repair & maintenance of the Model A Ford.		39.95 ea.
AB-32-2	<b>Mechanics Model A Handbook, Vol. 2</b> Pages of information on installing top wood kits, door bumpers, rumble conversions, plus several modern items to enhance your driving of the Model 'A'.		32.95 ea.
AB-33	<b>Diagnosing Model A Ford</b> Trouble shooting guide with hundreds of illustrations, including in depth analysis. 200 pages.		28.50 ea.
AB-35	<b>The Model A Engine Manual</b> This step by step manual has special sections on the distributor and oil pump. Over 150 photos, many in color. Spiral bound 112 pages for easy use.		24.95 ea.
AB-36	<b>Advertising the Model A Ford.</b> A collections guide to Model 'A' Ford magazine advertising. Over 400 photographs. By James Thomas.		39.95 ea.

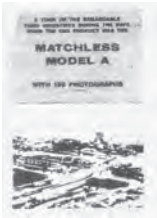

AB-24



AB-25

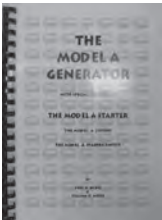

AB-29



AB-30



AB-32



AB-33



AB-35



AB-36



# Model B & V8 Parts 1932-1948

Part #	Description	Reqd.	Years	Price
<b>Wheels &amp; Tires</b>				
B-1012	Hub Bolt Nut. Passenger Car.		1932-53	.50 ea.
68-1107	Hub Bolt, Straight Sided. .56 x 1.56". Front & Rear. Pick-Up Passenger Car		1939-47 1936-48	3.50 ea.
B-1130-S	Hub Cap, Ford Script. Stainless Steel. 4 cyl. Passenger & Commercial.		1932-33	22.95 ea.
18-1130	Hub Cap, V-8. Stainless steel. Passenger.		1932	19.95 ea.
40-1130	Hub Cap, V-8. Stainless steel. Passenger.		1933	19.95 ea.
40-1130-A	Hub Cap, V-8. Stainless steel. Passenger & Commercial.		1934	19.95 ea.
46-1130	Hub Cap, Ford Script. Stainless Steel. 4 cyl. Passenger & Commercial.		1934	19.95 ea.
48-1130	Hub Cap, V-8. Stainless Steel. Pass. & Comm.		1935	19.95 ea.
01A-1130	Hub Cap. Stainless Steel. 1940 Std. Passenger & 1940-41 Commercial.			22.95 ea.
01A-1130-C	Hub Cap. Stainless Steel. Deluxe Passenger.		1940	22.95 ea.
11A-1130	Hub Cap. Stainless Steel. 1941 Passenger & 1941-42 Commercial			22.95 ea.
21A-1130	Hub Cap. Stainless Steel. 1942 Passenger & 1946 Commercial			22.95 ea.
51A-1130	Hub Cap. Stainless Steel. Passenger Car.		1946	22.95 ea.
6A-1130	Hub Cap. Stainless Steel. 1947-48 Passenger & 1947-56 Commercial.			22.95 ea.
V8-1130-1	Beauty Ring. Stainless Steel. 15" Smooth.		All years	29.95 ea.
V8-1130-2	Beauty Ring. Stainless Steel. 16" Smooth.		All years	29.95 ea.
V8-1130-5	Beauty Ring. Stainless Steel. 15" Ribbed.		All years	29.95 ea.
V8-1130-6	Beauty Ring. Stainless Steel. 16" Ribbed.		All years	29.95 ea.
BS1-1130-SS	Smooth Hub Cap. One ring style. Stainless steel. Non-Original.		1932-35	19.95 ea.
BS3-1130-SS	Smooth Hub Cap. Three ring style. Stainless steel. Non-Original.		1932-36	19.95 ea.
51A-1139	Front Hub Dust Cap. Drive-in type.	2	1940-50	4.95 ea.
78-1175	Rear Wheel Grease Seal. Fits in hub, 2.84" diameter.	2	1938-48	3.95 ea.
78-1180	Snap Ring for 68-1225 & 78-1175.	2	1938-48	1.50 ea.
48-1190-A	Front Wheel Inner Grease Retainer.	2	1935-48	3.25 ea.
68-1225-A	Rear Wheel Roller Bearing. Fits in hub.	2	late '36-48	32.95 ea.
91A-2004				
<b>Brakes</b>				
40-2000	Adapter Ring Set for Juice Brakes. (See A-2000)	1	1928-36	16.95 set
91A-2004	Master Cylinder Rebuilding Kit. 1939-48 Passenger & 1939-47 Commercial	1		22.95 kit
48-2035	Brake Shoe Retracting Spring. Pass. & Comm.	8	1935-36	3.95 ea.
91A-2035	Brake Shoe Return Spring.	4	1939-48	2.50 ea.
21A-2061	Front Wheel Cylinder. Passenger Side. (Right)	1	1939-48	49.95 ea.
21A-2062	Front Wheel Cylinder. Driver's Side. (Left)	1	1939-48	49.95 ea.
91A-2078	Rear Brake Hose. 8.80" long. 1939-48 Passenger & 1939-41 Commercial	1		12.95 ea.
99A-2079	Front Brake Hose. 15.5" long. 1939-52 Passenger & 1939-47 Commercial	2		12.95 ea.
11A-2091-A	Hand Brake Clevis Rubber Anti-Rattle Washer.	1	1941-48	1.25 ea.

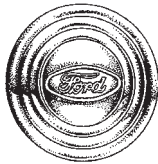

B-1130-S



18-1130



01A-1130-C



V8-1130-1



BS1-1130-SS



BS3-1130-SS



91A-2004



48-2035

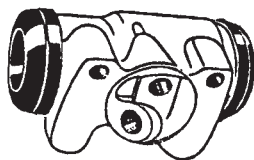

21A-2061



91A-2078

All prices listed in catalog subject to change. Call for current prices.



# Model B & V8 Parts

Part #	Description	Reqd.	Years	Price
<b>Brakes</b>				
91A-2128-K	Rear Wheel Cylinder Repair Kit. 1939-48 Passenger & 1939-47 Commercial.	1		3.50 ea.
91A-2140	Master Brake Cylinder Assembly. 1939-48 Passenger & 1939-52 Commercial.	1		75.00 ea.
91A-2142	Master Cylinder Access Hole Cover. The rubber on steel cover that fits in the steel floorboard. Keeps dust & moisture out of interior. Car & Truck.		1939-48	4.95 ea.
91A-2143	Brake Pedal Rod to Master Cylinder. Passenger & Commercial.	1	1939-48	11.95 ea.
91A-2180	Master Cylinder Rubber Dust Boot. Fits #91A-2140.	1	1939-52	2.95 ea.
91A-2221-K	Front Wheel Cylinder Repair Kit. (1-1/4" diameter cups).	1	1939-41	3.50 ea.
21A-2221-K	Front Wheel Cylinder Repair Kit. (1-3/8" diameter cups).	1	1942-48	3.50 ea.
91A-2261	Rear Wheel Cylinder. Passenger Side. (Right) (1-1/8" x 1).	1	1939-48	49.95 ea.
91A-2262	Rear Wheel Cylinder. Driver's Side (Left) (1-1/8" x 1).	1	1939-48	49.95 ea.
91A-2275-B	Hand Brake Cable Assembly with Dust Boots. (122" long). Passenger & Comm.	1	1939-41	18.95 ea.
21A-2275	Rear Brake Cable. Passenger Car.	1	1942-48	19.95 ea.
11A-2454-R	Brake & Clutch Pedal Pads. Bullseye design. Rubber over steel.	1	1940-48	9.95 pr.
48-2472	Brake Pedal Retracting Spring. Pass & Comm.	1	1935-36	2.50 ea.
91A-2476-S	Clutch & Brake Pedal Weather Seals.	1	1937-48	5.95 pr.
91A-2597-A	Emergency Brake Cable Rubber Dust Boots.	1	1939-48	3.95 pr.

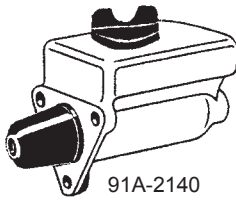

91A-2140



91A-2142

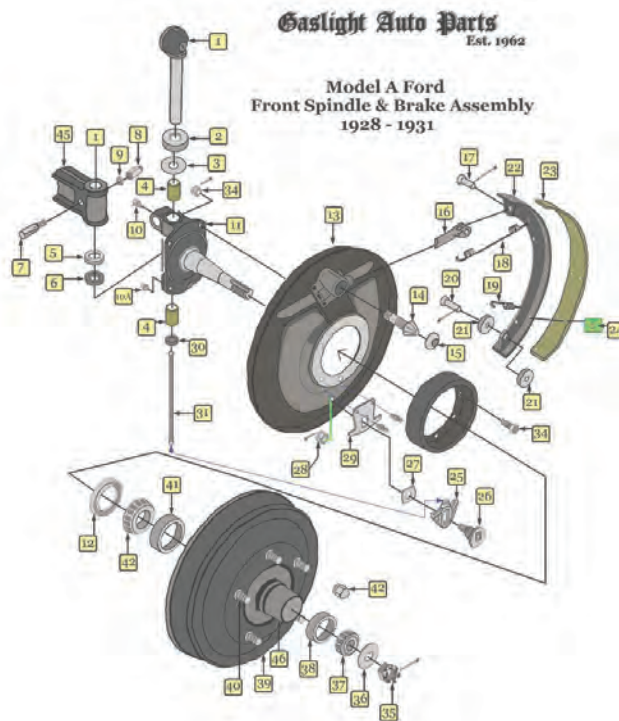

All prices listed in catalog subject to change. Call for current prices.

# Model B & V8 Parts 1932-1948

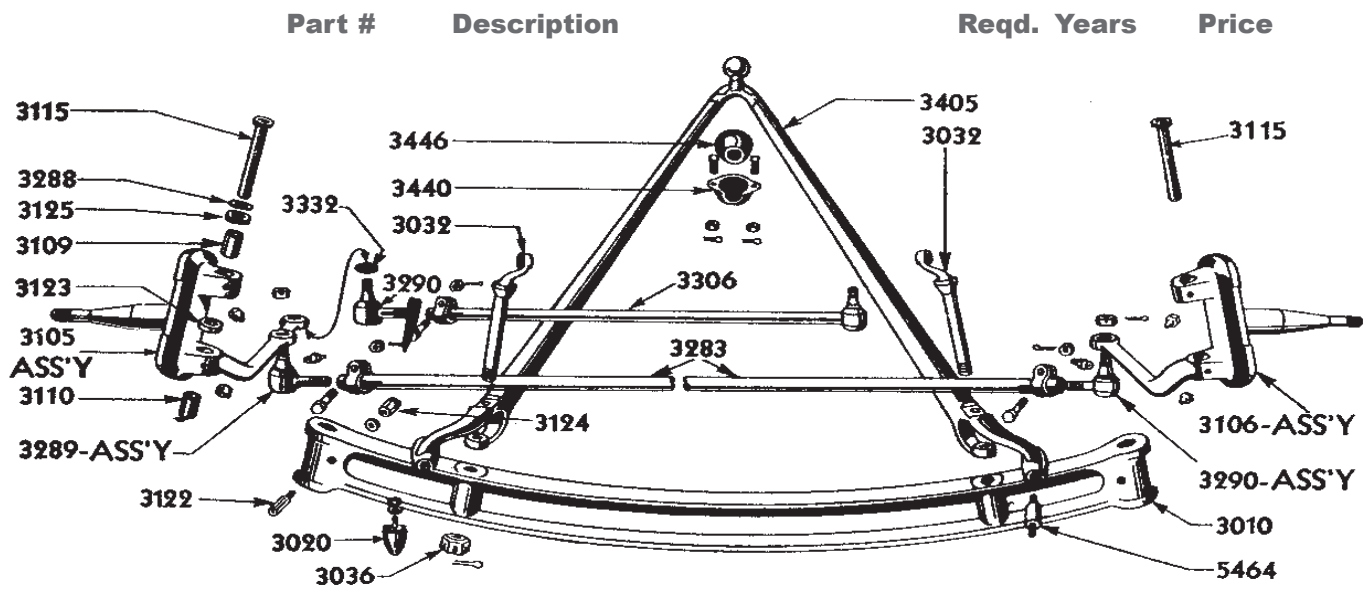

## Front Axle

**Please Note** The illustrations shown in this section are for reference. Basic numbers only are shown in the illustrations. Order by Part Number shown in the list of parts. Not all items pictured are available.

11A-3020	Front Axle Rubber Bumper. Passenger & Commercial. (also 48-56 Trucks).	2	1941-42	5.95 ea.
B-3111-S	Spindle Bolt Set. Passenger & Commercial.	1	1932-34	119.95 set
48-3111-S	Spindle Bolt Set. Passenger & Commercial.	1	1935-36	89.95 set
78-3111-S	Spindle Bolt Set. Passenger & Commercial.	1	1937-41	49.95 set
21A-3111-S	Spindle Bolt Set. 1942-48 Passenger. 1942-52 Commercial.	1		49.95 set
11A-3289	Tie Rod End, Right Hand. Passenger & Commercial.	1	1935-48	13.95 ea.
11A-3290	Tie Rod End, Left Hand. (Also fits drag link assembly). Passenger & Commercial.	1	1935-48	13.95 ea.
40-3305	Drag Link Assembly. Pass. & Comm.	1	1933-34	39.95 ea.
21A-3306	Steering Drag Link Assembly with Both Ends. Passenger Car.	1	1942-48	99.95 ea.
11Y-3306-A	Steering Drag Link Assembly with Both Ends. Passenger & Pickup.	1	1935-40	109.95 ea.
11A-3310	Tie Rod End Coupling Sleeve.		1935-73	7.95 ea.

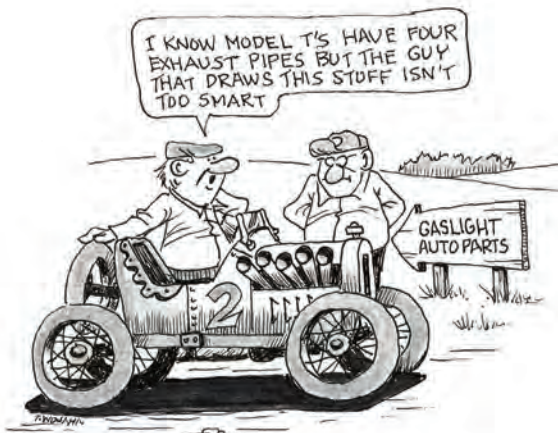

*We may have  
the part for your  
old race car?  
Call and inquire.*

[www.gaslightauto.com](http://www.gaslightauto.com)

# Model B & V8 Parts

*Highest quality parts provided by our knowledgeable staff for your restoration needs.*

**Part # Description Req'd. Years Price**

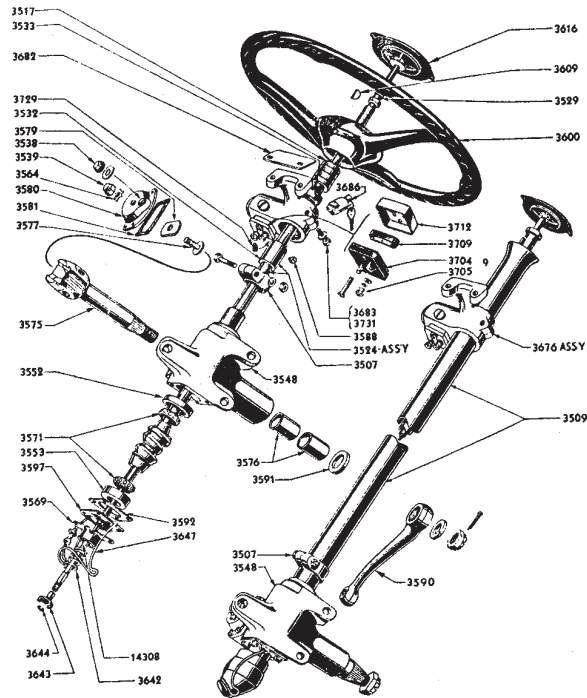

## Steering

We have many more Model B parts as many are interchangeable with the Model A. Send your needs with part number, description, and body style. Also check your parts book, noting Model A number, and then check over the Model A section.

40-3517	Upper Column Original Rubber Bushing.	1	1932-40	5.95 ea.
40-3524-C	Steering Worm, 15 to 1 ratio. Pass. & Comm.	1	1932-34	64.95 ea.
78-3524	Steering Worm. Passenger & Commercial.	1	1937-48	64.50 ea.
B-3552	Steering Worm Gear Bearing Lower Cup. (Fits 5A cone). Passenger & Commercial. Also upper cup. (Fits 513C cone) 1937-48 Passenger & Commercial.	1	1932-36	8.95 ea.
8A-3553	Steering Worm Gear Bearing Lower Cup. Fits 68-3571-A #5BC.	1	1937-56	16.95 ea.
B-3571	Steering Worm Roller Bearing. (5BA). Fits #6 cup.	2	1932-35	19.95 ea.
68-3571-A	Steering Worm Roller Bearing.	2	1936-56	7.95 ea.
40-3575-B	Sector. Fits steering worm. 15 to 1 ratio. Fits 40-3524-C above. Pass. & Comm.	1	1932-34	128.50 ea.
48-3575	Sector. Fits steering worm. 15 to 1 ratio. Passenger & Commercial.	1	1935	84.95 ea.
68-3575	Sector. Fits steering worm. 17 to 1 ratio. Passenger & Commercial.	1	1936	127.95 ea.
68-3576	Bushing. Fits Steering Sector. Pass. & Comm.	2	1936-60	6.95 ea.
78-3576-A	Bushing. Fits Steering Sector. 1932-35 & 1937-52	2		3.95 ea.
B-3581	Steering Housing Gasket Set. Pass. & Comm.	1	1932-36	9.95 set
78-3581	Steering Housing Gasket Set. Pass & Comm. (7 pc. set)	1	1937-48	9.95 set
B-3616	Horn Rod & Light Switch Assembly. 4 & 8 cyl. Passenger & Commercial. 42 1/2" length.	1	1932	66.95 ea.

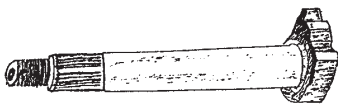

68-3575



68-3576



78-3576-A

All prices listed in catalog subject to change. Call for current prices.

# Model B & V8 Parts 1932-1948

Part #	Description	Reqd.	Years	Price
<b>Rear Axle &amp; Drive Shaft</b>				
18-4035-KIT	Rear Axle & U Joint Gasket Set. Includes .003, .005, .007, .009 rear end gaskets.	1	1935-48	29.95 set
18-4221	Differential Bearing. 8 cyl. Pass. & Comm.	2	1932-36	94.95 ea.
68-4221	Differential Bearing. 1937-52 Passenger & 1937-47 Commercial	2		36.95 ea.
18-4222	Differential Bearing Cup. Pass. & Comm.	2	1932-36	24.95 ea.
68-4222	Differential Bearing Cup. 1937-52 Passenger & 1937-47 Commercial	2		21.95 ea.
48-4616	Drive Pinion Bearing Cup. Pass. & Comm, (Requires 2 ea. #48-4621.)	1	1935-48	74.95 ea.
18-4621	Drive Pinion Bearing. Pass. & Comm.	2	1932-34	16.95 ea.
48-4621	Drive Pinion Bearing. (Used w/ #48-4616.)	2	1935-48	55.95 ea.
18-4625-A	Drive Pinion Pilot Bearing.	1		36.95 ea.
18-4634	Drive Pinion Bearing Nut. 1932-48 Passenger & 1932-47 Commercial	2	1932-48	2.95 ea.

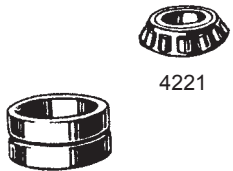

4221



4616



18-4625-A



18-4634

## License Brackets

B-5034	Front License Bracket w/ Cast Mounting Bracket. Exact duplicate of original. Pass. & Comm. 4 & 8 cyl.	1	1932	28.95 ea.
40-5034-C	Front License Bracket Assembly. Complete. Exact duplicate of original. Pass. & Comm.	1	1933-36	18.95 ea.
91A-5034	Front License Bracket Assembly. Complete. Exact duplicate. 1939 Passenger Deluxe & 1937-41 Standard	1		18.95 ea.
B-5041-SS	Front Spreader Bar, Straight. Includes mounting hardware.	1	1932	59.95 ea.
B-5151	Battery Support Assembly. Stamped steel. Passenger & Commercial. Also big Trucks.	1	1932-34	29.95 ea.
40-5151	Battery Support Assembly. Stamped steel. Passenger & Commercial.	1	1933-34	28.95 ea.
01A-5151	Battery Box. Stamped steel. 1940 Passenger Car & 1940-41 Pickup Truck.	1		34.95 ea.

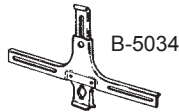

B-5034

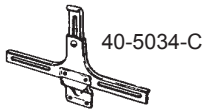

40-5034-C



B-5041-SS

## Exhaust *No current supplier. Please Inquire.*

40-5230	Muffler. V-8, 85 hp. Pass. & Comm.	1	1932-34	84.95 ea.
48-5230-B	Muffler. V-8, 85 hp. Pass. & Comm.	1	1935-38	59.95 ea.
40-5245	Exhaust Header Pipe. Connects engine to muffler. 85 hp. Car and Commercial vehicle.		1933-34	59.95 ea.
48-5245	Exhaust Header Pipe. Pass. & Commercial.	1	1935-36	79.95 ea.
91A-5245-A	Exhaust Header Pipe. 95 hp. Pass. & Comm.	1	1937-40	79.95 ea.
21A-5246	Exhaust Header Pipe. Passenger Car only. 95/100 hp V-8. (Except w/ hot air heater).	1	1942-48	79.95 ea.
18-5251	Muffler Inlet Pipe Clamp. Pass. & Comm.	1	1932-46	5.95 ea.
40-5255	Tail Pipe. (2 pc.) Duplicates the original Ford style. Car and Commercial vehicle. 4 & 8 cyl.		1933-34	69.95 set
48-5255	Tail Pipe. 85 hp. Passenger Car.	1	1935-38	74.95 ea.
91A-5255	Tail Pipe. 85 hp. Passenger Car.	1	1937-40	74.95 ea.

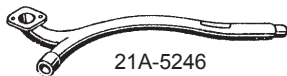

21A-5246



18-5251



48-5255

All prices listed in catalog subject to change. Call for current prices.

# Model B & V8 Parts

Part #	Description	Reqd.	Years	Price
<b>Exhaust</b> <i>No current supplier. Please Inquire.</i>				
6A-5255	Tail Pipe. 100 hp. All Passenger Cars Except Station Wagons.	1	1942-48	54.95 ea.
11A-5259	Muffler Outlet Pipe Bracket. Holds outlet pipe at rear of muffler to the frame. V-8 85/95 hp.	2	1939-46	7.95 ea.
21A-5261	Muffler Outlet Pipe Bracket.	1	1939-48	7.95 ea.
18-5267	Crossover Pipe. V-8. Pass. & Comm.	1	1932	49.95 ea.
40-5267	Crossover Pipe. V-8. 85 hp. Pass. & Comm.	1	1933-34	29.95 ea.
48-5267	Crossover Pipe. V-8. Pass. & Comm.	1	1935-36	29.95 ea.
78-5267	Crossover Pipe. 85/95 hp. Pass. & Comm.	1	1937-41	29.95 ea.
51A-5267	Crossover Pipe. 95/100 hp. Pass. Car.	1	1942-48	29.95 ea.



51A-5267



18-5304



21A-5304-A

## Spring Shackle Sets

18-5304	Front Spring Shackle Set. Steel bushings & steel bars. (16 pcs.) Passenger & Commercial.	1	1932-34	22.95 set
48-5304-A	Front Spring Shackle Set. Steel bushings & steel bars. (16 pcs.) Pass.& Comm.	1	1935-40	22.95 set
21A-5304-A	Front Spring Shackle Set. Rubber bushings. Steel pins & steel bars. (16 pcs.) Passenger	1	1942-48	39.95 set
18-5630	Rear Spring Shackle Set. Steel bushings & steel bars. Passenger & Commercial.	1	1932-34	39.95 set
48-5630	Rear Spring Shackle Set. Steel bushings & steel bars. (16 pcs.) Pass.& Comm.	1	1935-40	22.95 set
21A-5630	Rear Spring Shackle Set. Rubber bushings. Steel pins & steel bars. (16 pcs.)	1	1942-48	22.95 set

All prices listed in catalog subject to change. Call for current prices.

*Highest quality parts provided by our knowledgeable staff for your restoration needs.*



# Model B & V8 Parts 1932-1948

Part # Description Req'd. Years Price

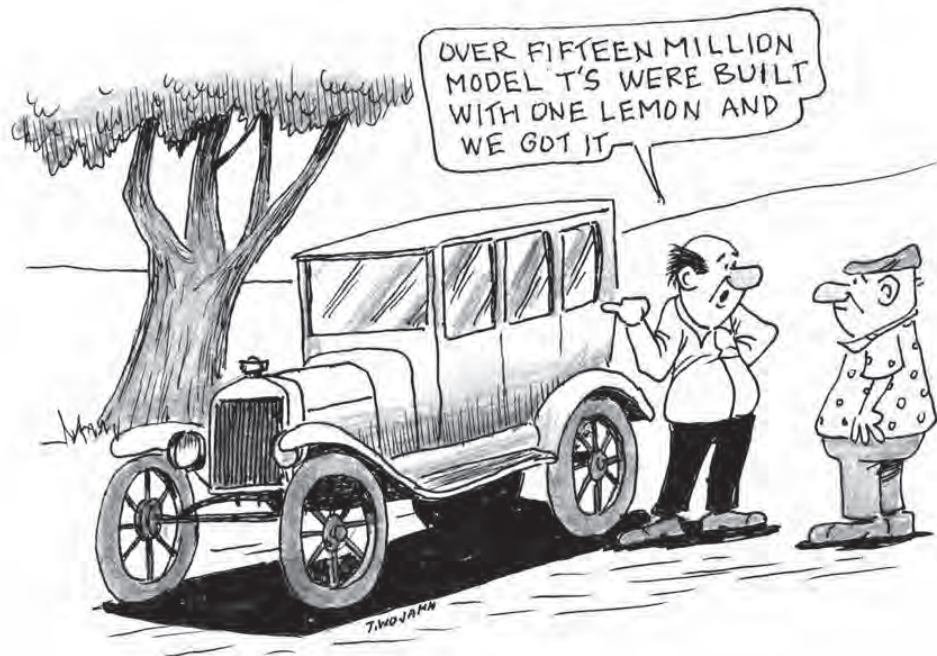

## Engine

B-6008	Engine Gasket Set. Complete w/ copper head gasket. 4 cyl.	1	1932-34	59.95 set
18-6008	Engine Gasket Set. Complete w/ head gaskets. 21 stud engine. 85 hp.	1	1932-37	119.95 set
74-6008	Engine Gasket Set. Complete w/ head gaskets. 60 hp engine.	1	1937-40	179.95 set
91A-6008	Engine Gasket Set. 24 Stud. 85 hp. V-8.	1	1938-42	99.95 set
99A-6008-C	Engine Gasket Set. Complete w/ head gaskets. 100 hp 24 stud engine.	1	1939-48	110.00 set
B-6008-C	<b>NEW</b> Complete Gasket Set w/Copper Head Gasket.			74.95 ea.
B-6038-C	Insulator. Front upper & rear upper Engine rubber biscuit.	4	1932-48	4.95 ea
78-6039-A	Insulator. Engine front & rear support, lower.	4	1932-48	2.95 ea
B-6047-S	Front or Rear Motor Mount Kit. Contains rubber cushions, bolts & nuts, washers & cups. V-8's only. (12 pc. set)		1932-48	56.95 kit
B-6051-C	Copper Head Gasket. 4 cyl. (Seam around cylinder holes face up.)	1	1932-34	29.95 ea.
40-6051	Head Gasket, Copper. 21 stud. V-8. 85 hp.	2	1932-37	49.95 ea.
41A-6051	Cylinder Head Gasket. 85 hp. 24 stud. Composition material with small water holes for alum. heads.	2	1938-42	19.95 ea.
52-6051-B	Head Gasket. Fits 17 stud 60 hp. All years. For aluminum or cast iron head.	1	1937-40	29.95 ea.



B-6047-S

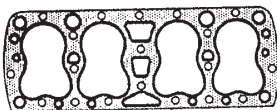

-6051

All prices listed in catalog subject to change. Call for current prices.

# Model B & V8 Parts

Part #	Description	Reqd.	Years	Price
<b>Engine</b>				
91A-6051	Head Gasket. Steel/Bestos. 85-90 hp. 24 stud engine with large water openings.	2	1938-42	27.50 ea.
59A-6051	Head Gasket. Copper with small water openings. 24 Stud. 95-100 hp.	2	1938-49	26.95 ea.
B-6051-M	Modern Steel Core Head Gasket. 'B' This premium steel core w/outer layers of high density silicone coated gasket material. Has high temp. silicone bead around all water passages and head studs. Fits 'A' high compression head and 'B' head.		1932-34	36.95 ea.
40-6051-S	Head Gasket. Steel clad. 85 hp., 21 stud.		1932-37	23.95 ea.
V8-6149	Piston Ring Set. Specify Year & Size, 3 Ring or 4 Ring.		1932-48	49.95 set
21A-6207-A	Connecting Rod Bushing. 1.36" long x .735" I.D. 90 & 100 hp.	8	1942-48	4.95 ea.
V8-6211-A	Connecting Rod Bearings. Many sizes. State engine year & crankshaft diameter. (Sold in sets of 4's for 8 rods).	1	1932-48	49.95 set
18-6254-A	Oil Pump Drive Gear. At rear of camshaft with round inside. 85-95 hp.	1	1932-41	15.95 ea.
18-6254-B	Oil Pump Drive Gear on Camshaft. Flat inside 85-95-100 hp.	1	1932-53	15.95 ea.
52-6256	Camshaft Fiber Timing Gear. Press on. 42 teeth, 60 hp, V-8. USA.	1	1937-40	34.95 ea.
48-6256-A	Camshaft Fiber Gear. Press on. 44 Tooth, 85 hp.	1	1935-41	49.95 ea.
91A-6256-A	Cam Gear. Fiber. Bolt on type. Oversize .003, 44 tooth.	1	1935-48	48.95 ea.
91A-6256-B	Cam Gear, Bolt On. Aluminum. 44 tooth.	1	1935-48	59.95 ea.
91A-6256-C	Cam Gear, Bolt On. Aluminum. Oversize .005". 44 tooth.	1	1935-48	48.95 ea.
11A-6256-D	Cam Gear. Fiber, bolt on. 44 tooth. 40-90-100 hp. 1-5/16 I.D. center.	1	1935-48	49.95 ea.
01A-6261	Cam Bearings. Full set. (3 pcs.)	1	1933-53	39.95 set
18-6306	Crankshaft Gear. 28 tooth. 85 hp. Passenger & Commercial.	1	1932-34	24.95 ea.
48-6306-A	Crankshaft Gear. 22 Tooth. 85 - 100 hp.	1	1935-48	29.95 ea.
81A-6319	Crankshaft Ratchet Nut. All except 60 hp.	1	1938-53	5.95 ea.
V8-6331	Rear Main Bearing. Specify exact year & all measurements. Not all sizes available. 6 & 8 cyl. 60-100 hp.	1	1932-48	39.95 ea.
V8-6333	Front & Center Main Bearing. Specify exact year & all dimensions. Not all sizes available. 6 & 8 cyl. 60-100 hp.	2	1932-48	29.95 ea.
78-6335	Rear Main Bearing Upper Seal. Fits single slinger crankshaft with V groove. 85 hp. V-8.	1	1937-42	14.95 ea.
91A-6335	Rear Main Bearing Upper Seal. Fits double slinger crankshaft with U shaped groove. 95/100 hp. V-8.	1	1939-48	29.95 ea.
B-6336-S	Rear Main Seal. Nitrile radial lip for positive seal. Instructions included. 4 cyl.	1	1932-34	21.95 ea.
78-6336	Rear Main Bearing Seal, Lower. Fits single slinger crankshaft. 85 hp. V-8.	1	1937-42	14.95 ea.

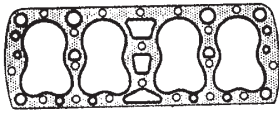

-6051



V8-6149



V8-6211-A

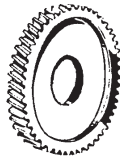

6256



01A-6261



All prices listed in catalog subject to change. Call for current prices.

# Model B & V8 Parts 1932-1948

Part #	Description	Reqd.	Years	Price
<b>Engine</b>				
19B-6336	Rear Main Bearing Lower Seal. Fits double slinger crankshaft with U shaped groove. 95-100 hp. V-8.	1	1939-48	29.95 ea.
B-6340/46	Main Bearing Shim Set. 4 cyl. (6 pcs.)	1	1932-34	8.95 set
91A-6500-AJ	Adjustable Tappets. V-8, 85-100 hp. (Set of 16 with wrenches).	1	1932-48	199.95 set
11T-6505-A	Valve, Intake & Exhaust. 1. 51" dia. x 4.76 long. 85-100 hp.	16	1932-48	15.95 ea.
40-6510-B	Valve Guide. Split type. 85-100 hp. USA.	16	1932-48	7.95 ea.
40-6512	Valve Guide Retainer.	16	1932-51	.95 ea.
78-6513	Valve Spring. 2.41" long. 85-100 hp.	16	1932-50	4.95 ea.
40-6514	Valve Spring Keeper. Mushroom stem valve spring retainer. 16 per engine. 85/100 hp.	16	1932-48	.50 ea.
B-6521	Valve Cover Gasket, 4 cyl. B & C. This is for the larger valve cover used on 4 cyl. engines.	1	1932-34	3.25 ea.
40-6521	Intake Manifold Gasket.	1	1933-48	7.95 ea.
52-6521	Intake Manifold Gasket. 60 hp.	1	1937-40	7.95 kit
18-6600K	Oil Pump Rebuilding Kit. 50#. 85-95 hp. V-8.	1	1932-42	59.95 kit
41A-6600K	Oil Pump Rebuilding Kit. 80# long style pump. 95-100 hp. V-8.	1	1935-48	49.95 ea.
52-6600-RK	Oil Pump Rebuild Kit. 60 hp. (3 pcs. & gaskets) Larger fiber gear not available.	1	1937-40	39.95 kit
59A-6600-N	Oil Pump less Screen & Pickup Tube. 80# short style.	1	1935-53	144.95 ea.
01A-6654	Oil Relief Valve Spring. 60, 85, 100 hp. Fits 50# pump.	1	1932-42	1.00 ea.
48-6756-A	Oil Pan Vent Tube. Used with cast iron manifold. 85-90-100 hp.	1	1935-48	4.95 ea.
18-6781	Oil Pan Gasket Set. V-8.	1	1932-34	9.95 set
48-6781	Oil Pan Gasket Set. 85-100 hp.	1	1935-48	15.95 set
B-6781	Oil Pan Gasket Set, 4 cyl. (4 pc. set)	1	1932-34	10.95 set
B-6805	Engine Snubber Rebuild Kit. Lubricant & instruction book included. 4 cyl. vehicles. USA.	1	1932-34	24.95 kit



11T-6505-A

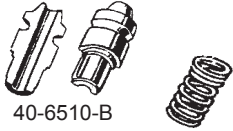

40-6510-B

78-6513



18-6600K



B-6805

All prices listed in catalog subject to change. Call for current prices.

## Transmission

Basic Numbers and Parts shown are for your assistance. Not all parts available. Check parts list for numbers.

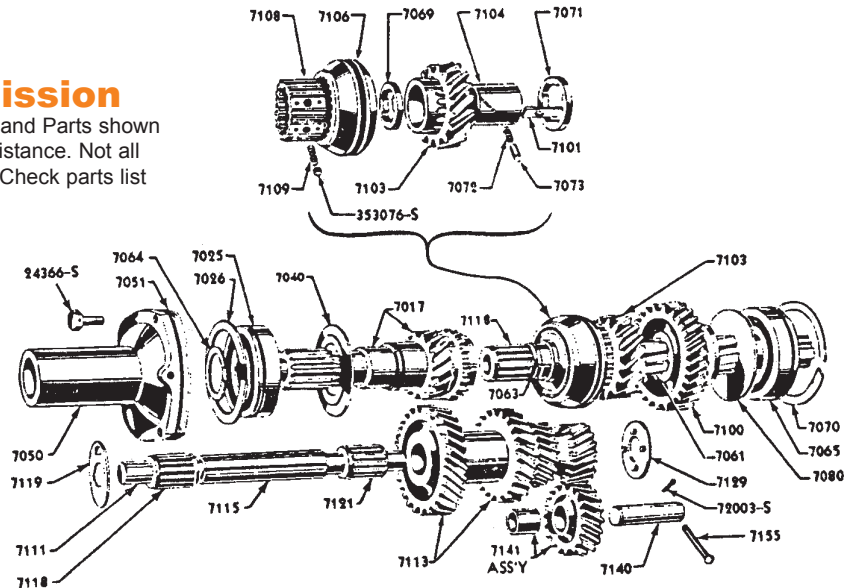



# Model B & V8 Parts

Part #	Description	Reqd.	Years	Price
<b>Transmission</b>				
48-7017	Main Drive Gear. Use with B, 48, 68 & 51A-7113 cluster gear. 16 helical teeth. 8.27" length. 4 & 8 cyl. Pass. & Comm. All except 60 hp.	1	1932-39	149.95 ea.
81A-7017	Main Drive Gear. 16 helical teeth. Use with 68, 51A, 8M-7113 cluster gear. 8.25" long. 85 & 100 hp (60 hp 1940 only) Passenger & Commercial.	1	1938-50	259.95 ea.
022A-7017	Main Drive Gear. 15 helical teeth. Use with 022A-7113-A cluster gear. 8.20" long. 4, 6 & 8 cyl, 90 & 100 hp (1940 60 hp)	1	1940-50	139.95 ea.
51A-7025	Main Drive Gear Bearing with Snap Ring. (Inside seal removeable with knife point). Fits #7017 Gear. Used Sept. '29 thru 1948.	1	1929-48	21.95 ea.
B-7050	Oil Seal Retainer for #51A-7025.	1	1932-36	28.95 ea.
78-7052	Main Drive Gear Oil Seal. 60, 85 & 100 hp. 4, 6, & 8 cyl.	1	1937-48	3.95 ea.
B-7064	Snap Ring. For transmission main drive pilot bearing.	1	1932-48	1.95 ea.
51A-7065	Main Drive Gear Bearing with Snap Ring. (Inside seal removeable w/ knife point). Fits #7061 series. Used Sept. '29 thru 1948.	1	1929-48	21.95 ea.
B-7069	Second Gear Front Thrust Washer.	1	1932-38	4.50 ea.
B-7071	Thrust Washer. For transmission main shaft 2nd gear, rear. 4 cyl. & V-8.	1	1932-35	4.50 ea.
B-7100	Low & Reverse Gear. 29 teeth, 6 splines. Used with #B-7061. Straight teeth.	1	1932-35	79.95 ea.
01A-7100	Low & Reverse Gear. 29 helical teeth, 16 helical splines. (Use with #68, #81A & #51A-7061).	1	1936-50	107.95 ea.
01A-7106	Outer Sleeve. Fits synchronizer hub. 2nd & high. 4, 6 & 8 cyl.	1	1940-60	49.95 ea.
81A-7107-D	Synchronizer Brass Ring, 2nd Gear. 4, 6, 8 cyl. Use with #81A, #01A, #51A-7106.	2	1939-60	5.95 ea.
B-7111	Cluster Gear Countershaft. Fits all 4, 6, & 8 cylinder. 8-9/32" long.	1	1932-48	7.95 ea.
B-7119-A	Cluster Gear Front Thrust Washer. 4, 6, 8 cyl. (Also rear in 1932-34, 8 cyl.)	2	1932-48	4.95 ea.
01A-7124-A	Trans. Synchronizer Assembly with Brass Rings. 3 clip style. 4, 6, & 8 cyl.	1	1940-56	119.95 ea.
B-7129	Rear Cluster Gear Plate. 5 lugs. Use with #B, #48 & #67-7113.	1	1932-35	4.95 ea.
B-7140	Transmission Reverse Idler Shaft. 4, 6, 8 cyl.	1	1932-50	19.95 ea.
B-7141	Reverse Idler Gear. 18 Teeth. Use with B, 48, 67-7113. 4,6,8 cyl.	1	1932-35	38.95 ea.
68-7141	Reverse Idler Gear. 18 helical teeth. 2.46" od. 4, 6 & 8 cyl. Use with 68, 022A, 21C, 51A & 8M-7113.	1	1936-50	74.95 ea.
B-7153	Transmission Gasket Set. 4, 6 & 8 cyl. (Top shift transmission).	1	1932-48	10.95 set



81A-7107-D



B-7119-A



B-7141

All prices listed in catalog subject to change. Call for current prices.

# Model B & V8 Parts 1932-1948

**Part # Description Req'd. Years Price**

## Transmission

Part #	Description	Req'd.	Years	Price
01A-7506	Pedal Shaft, Clutch & Brake Pedals. 5-1/2" long. Passenger & Commercial.	1	1940-48	9.95 ea.
40-7508-A	Clutch Release Shaft Bushing. 1-3/8" long. Thin wall construction.	2	1932-50	2.95 ea.
51A-7508	Clutch Release Shaft Bushing. Thick wall construction. Bimetal type.	2	1940-48	5.95 ea.
01A-7517	Clutch Release Equalizer Shaft Split Bushings. (4 pc. set) Fits #01A-7510.	1	1940-65	2.95 set
B-7533-B	Clutch Pedal Clevis Pin. The special grooved head pin for clutch pedal clevis.	1	1932-48	1.50 ea.
91A-7550	Clutch Disc Assembly. 9" dia. Made in USA. (Fits All, Except 60 hp 1937-39)	1	1928-40	42.95 ea.
29A-7550	Clutch Disc Assembly. 10" dia. 6 & 8 cyl. Passenger & Commercial.	1	1941-56	49.95 ea.
40-7561	Hub, Clutch Release Bearing. Holds throw-out bearing.	1	1932-34	19.95 ea.
48-7561	Clutch Release Bearing Hub. Holds throwout bearing.	1	1935-52	24.95 ea.
48-7562	Clutch Release Bearing Hub Spring. All except 60 hp.	1	1935-48	1.50 ea.
09A-7563	Pressure Plate. 9" dia. <i>Exchange only.</i> 85-95 hp.	1	1935-42	97.95 ex.
19A-7563	Pressure Plate. 10" dia. <i>Exchange only.</i> 6 & 8 cyl. (Also 1954-56 292 ci. 4V engine).	1	1941-56	97.95 ex.

## Radiator & Grille

B-8100	Radiator Cap. Die cast chrome. Passenger & Commercial.	1	1932	32.95 ea.
B-8100-RK	Radiator Cap Repair Kit. USA. Contains solid brass parts to replace those parts that corrode easily. Also required when installing Grehound Cap on 1932-33-34 Cars and 1932-36 Pickup Trucks and original 1932 Quail Cap.	1		9.95 kit
40-8100-A	Radiator Cap. Die cast chrome. Pass Car.	1	1933	18.95 ea.
40-8100-B	Radiator Cap. Die cast chrome. Pass Car.	1	1934	18.95 ea.
46-8100-A	Radiator Cap. Die cast chrome. Comm.	1	1933	18.95 ea.
46-8100-B	Radiator Cap. Die cast chrome. Pickup.	1	1934-36	18.95 ea.
91A-8100	Radiator Cap. Under hood type. Non-Pressure. Passenger & Commercial.	1	1937-48	6.95 ea.
B-8133-SS	Radiator Support Rods. Stainless steel.	1	1932-39	38.95 pr.
B-8200	Radiator Shell. Die stamped. Hot rod style. No opening for radiator cap. Stock height. Less grille insert.	1	1932	288.50 ea.
B-8201	Grille Insert for B-8200 Grille Shell. Stock height less crankhole for street rod. Polished stainless steel.	1	1932	349.95 ea.
B-8212	Radiator Emblem. Blue enameled. Fits 1932 cars & 1932-35 commercial.			14.95 ea.
40-8212	Radiator Emblem. Blue enameled. 1934 Passenger & 1938 Deluxe Car	1		18.95 ea.



51A-7508



40-7508-A

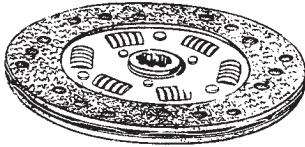

-7550



B-8133-SS



B-8100

40-8100-B

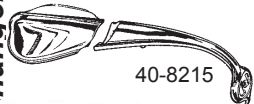

40-8215



B-8200



B-8212



B-8201

Change. Call for current prices.

All prices listed in

# Model B & V8 Parts

Part #	Description	Reqd. Years	Price
<b>Radiator &amp; Grille</b>			
48-8212	Radiator Emblem. Blue Enameled. Fits 1935-36 Pass., 1936 Comm. & 1938 Standard	1	18.95 ea.
B-8215	Radiator Neck, Chromed. Exact Duplicate. Passenger & Commercial.	1 1932	32.50 ea.
40-8215	Grille Top Ornament, Chromed. Passenger.	1 1934	24.95 ea.
46-8215	Hood Ornament. Pickup Truck. Uses B-8212 emblem.	1 1934-35	52.95 ea.
01A-8215-A	Hood Release Handle. Standard.	1 1940	19.95 ea.
01A-8215-C	Hood Release Handle. Deluxe.	1 1940	22.95 ea.
40-8217-A	Grille Ornament.	1	22.95 ea.
40-8217-B	1933 Passenger & 1933-35 Pickup Grille Grille Ornament. Duplicate. of original. Pass.	1 1934	34.50 ea.
01A-8218-B	Hood Ornament w/ Handle, Front. Deluxe Passenger	1 1940	119.95 ea.
B-8220	Hood Hinge Front Bracket w/ Stainless Steel Screws. Original style. Pass. & Comm. (Also 1935-36 rear bracket).	1 1932-35	8.95 ea.
40-8220-A	Hood Hinge Front Bracket. Fits 1932-35 Passenger & Commercial & rear bracket 1935-36 Passenger.	1	2.50 ea.
40-9417	Fuel Pump to Stand Mounting Gasket. Used when installing fuel pump to the intake manifold stand. 85-100 hp.	1 1933-48	1.00 ea.
46-8220-A	Hood Hinge Bracket. Front & rear. Pickup.	1 1935-37	8.95 ea.
B-8221	Rear Hood Hinge Bracket. Chrome. Passenger & Commercial.	1 1932	14.95 ea.
68-8226	Front Hood Hinge Bracket. Passenger Car.	1 1936	5.95 ea.
78-8260	Upper Radiator Plain Hose. 85 hp. 1937-38 and 1939 Standard.	2	18.95 ea.
91A-8260	Upper Radiator Hose w/Metal Support. 85-95 hp. 1939 Deluxe & 1940-41	2	18.95 ea.
21A-8260	Upper Radiator Hose w/Metal Support. 100 hp.	2 1942-48	18.95 ea.
B-8260/86	Radiator Hose Set. (3 pcs.) Fits all 4 cyl. B & C engines. Passenger & Commercial.	1 1932-34	16.95 set
91A-8286-B	Lower Radiator Hose. 85-95 hp. 1939 Deluxe & 1940-41	2	12.95 ea.
21A-8286	Lower Radiator Hose. 85-100 hp 1932-39 & 1942-48 V-8, 85-100 hp 1 3/4" x 6" long.	2	5.95 ea.

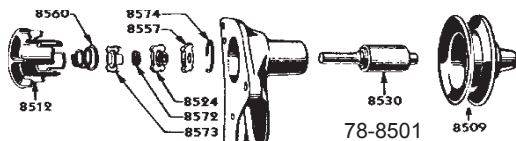
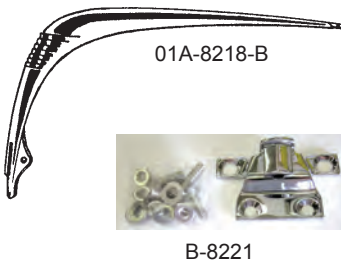
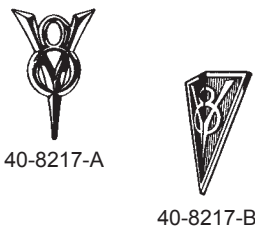

**Basic Numbers and Parts shown are for your assistance. Not all parts are available. Check parts list for numbers.**

## Water Pump

68-8501	Water Pump Assembly. Fits left or right side of cylinder head. 85 hp engine.	2 1932-36	99.95 ea.
78-8501	Water Pump Assembly, Right Hand. Bolts on front of engine. 85-100 hp.	1 1937-48	124.95 ea.
78-8502	Water Pump Assembly, Left Hand. Bolts on front of engine. 85-100 hp.	1 1937-48	124.95 ea.

# Model B & V8 Parts 1932-1948

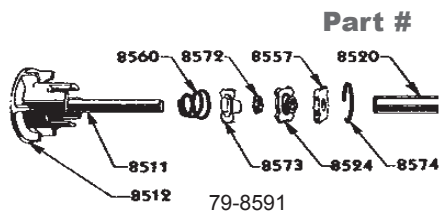

**Part # Description Req'd. Years Price**

**Basic Numbers and Parts shown are for your assistance. Not all parts are available. Check parts list for numbers.**

## Water Pump



11A-8575



68-8591

18-8507	Water Pump Cylinder Head Gasket. Fits water pump housing at cylinder head. 85 hp V-8 engine.		1932-36	1.95 pr.
B-8507	Water Pump to Cylinder Head Gasket. 4 cyl.		1932-34	.60 ea.
B-8510-SS	Stainless Steel Water Pump Shaft. With Impeller pinned in place. 4 cyl. Model B.	1	1932-34	52.50 ea.
B-8512	Water Pump Impeller. Cone shaped machined alloy impeller cross drilled for mounting to shaft. 4 cyl. Passenger and Commercial.	1	1932-34	39.95 ea.
68-8524-A	Water Pump Seal Kit. V-8.	2	1932-36	2.95 ea.
11A-8575	Thermostat 160 degree. 85-100 hp. (except 60 hp.)	2	1937-48	9.95 ea.
11A-8575-HT	Thermostat. 180 degree. 85-100 hp.	2	1937-48	9.95 ea.
68-8591	Water Pump Rebuilding Kit. 85 hp, V-8. For pumps mounted on cylinder head.	2	1932-36	39.95 kit
78-8591	Water Pump Rebuilding Kit. 85/90/100 hp. For pumps mounted on the front of engine.	2	1937-48	24.95 kit
79-8591	Water Pump Kit. Double pulley pump with bearing shaft. Used on large trucks. 85-90-100 hp. 4 cyl.	2	1937-41	29.50 kit
46-8600	Fan & Hub Assembly. 4 Blade. 4 cyl. 16-1/4" diameter.	1	1932-34	79.95 ea.
78-8600	Fan & Hub Assembly. 4 Blade. V-8, 85 hp. Standard. Pass. & Comm. (15.8" dia).	1	1937-39	59.95 ea.
40-8620	Fan Belt. V style for correct pulley fit & authentic look. U.S.A. 1933-36 Passenger & Commercial, also 1933-37 Truck.	1		16.95 ea.

## Fuel System

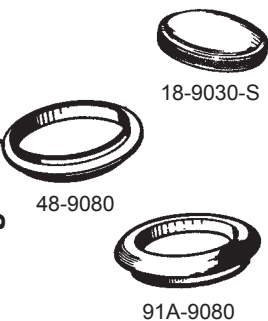

18-9030-S	Gas Cap. Stainless steel. Original style.	1	1932-48	9.95 ea.
40-9080	Fuel Tank Filler Pipe Grommet. Flat style. Passenger Car.	1	1933-34	5.95 ea.
48-9080	Fuel Tank Filler Pipe Grommet. Passenger & Commercial	1	1935-36	5.95 ea.
91A-9080	Fuel Tank Filler Pipe Grommet. 1937-40 Passenger & 1937-41 Pickup Truck	1		5.95 ea.
BB-9189	Fuel Shut-off Valve. Brass. Commercial & Large Trucks, 4, 6 & 8 cyl. (Except Panel Trucks & 194" wb School Bus 1940-47)	1	1932-47	36.95 ea.
01A-9275	Fuel Gauge Tank Unit. 6 volt. 1935-48 Passenger Car & 1937-41 Pickup	1		38.95 ea.
99A-9275	Fuel Gauge Tank Unit. 6 volt or 12 volt. Instructions. 1941-48 Cars & 1942-55 Pickups.	1		42.00 ea.
18-9288-A	Flexible Fuel Line. Fuel pump to main line. V-8. Exact duplicate.	1	1932-48	13.95 ea.
B-9349	Fuel Pump Kit. 4 cyl.	1	1932-34	59.95 ea.

All prices listed in catalog subject to change. Call for current prices.

# Model B & V8 Parts

Part #	Description	Reqd.	Years	Price
<b>Fuel System</b>				
11A-9349	Fuel Pump Kit, Glass Bowl Type. V-8, 85-100 hp.	1	1938-48	21.95 kit
68-9350	Fuel Pump w/ Steel Bowl. V-8, 85 hp. 1933-42 Original style. Used with aluminum valve cover thru 1946.	1	1933-42	59.95 ea.
59A-9350	Fuel Pump w/ Glass Bowl. V-8. Used on cast iron valve cover.	1	1933-48	62.95 ea.
91A-9369	Metal Gas Line from Pump to Carburetor. Copper line w/ fittings.	1	1932-48	4.95 ea.
48-9400-A	Fuel Pump Push Rod. 8.87" long. For cast iron manifold.	1	1933-48	8.95 ea.
48-9400-B	Fuel Pump Push Rod. 7.87" long. For aluminum manifold.	1	1933-48	9.95 ea.
52-9400-A	Push Rod, Fuel Pump. Used w/ aluminum intake manifold. 5-3/8" long. 60 hp.	1	1937-40	5.95 ea.
52-9400-B	Push Rod, Fuel Pump. Used w/ cast iron intake manifold. 6-3/8" long. 60 hp.	1	1937-40	5.95 ea.
18-9433	Exhaust Manifold Gasket Set. (8 pcs.)	1	1932-53	4.95 set
40-9447	Carburetor to Manifold Gasket. Stromberg carburetor.	1	1933-38	1.25 ea.
59A-9447	Carburetor to Manifold Gasket. Ford / Holley.	1	1938-48	.75 ea.
59A-9502	Gasket Set for 2 Barrel. Ford / Holley Carb.	1	1938-53	11.50 set
B-9502	Carb. Gasket Set, 'B' Zenith. 4 cyl.	1	1932-34	1.95 set
40-9502	Carb. Gasket Set, Stromberg 97.	1	1933-38	3.95 set
B-9550	Carburetor Float, Rectangular. Zenith B. Brass. 4 cyl.	1	1932-34	14.95 ea.
B-9590-Z	Zenith Carburetor Rebuild Kit. 4 cyl. Model B w/ ball type needle & seat. (18 pcs.)		1932-34	72.95 kit
52-9590	Carburetor Rebuild Kit. This kit fits 81 & 92 carburetors. 60 hp.	1	1937-40	72.95 kit
67-9590	Carburetor Rebuilding Kit for Dual Down Draft Stromberg #97. 85-90 hp.	1	1933-37	31.95 kit
59A-9590	Carb. Rebuilt Kit. V-8 Ford Model 94, 81A, 91-99. Holley 2100 Chandler 21-29 & 94. Not for 60 hp.	1	1938-56	31.95 kit
21A-9735	Accelerator Pedal. Passenger & Comm. pulley. <i>Exchange only.</i>	1	1935-47	14.95 ea.
<b>Generator</b>				
40-10043	Generator Brush Set for 3 Brush Generator. (3 pc. set)	1	1929-39	2.95 set
01A-10043	Generator Brush Set for 2 Brush Generator. (2 pc. set)	1	1940-55	2.50 set
18-10094	Generator Shaft Bearing at Front End Plate.		1932-36	4.50 ea.
78-10128	Generator Bushing at Rear End Plate.	1	1937-53	1.25 ea.
18-10505-R	Voltage Regulator. Solid state electronics. Not for Model A or T. Positive ground only. 6 volt. Looks like stock cutout.	1	1932-39	89.95 ea.
51A-10505	Generator Voltage Regulator, 35 amp. 6 volt.	1	1939-53	56.50 ea.

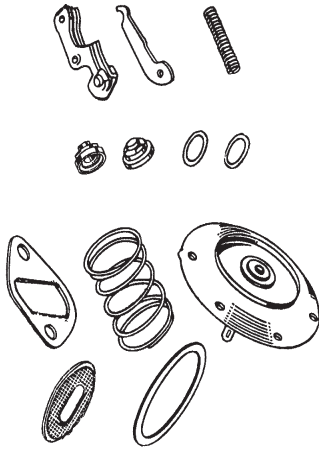



11A-9349 Fuel Pump Kit

*Highest quality parts provided by our knowledgeable staff for your restoration needs.*

*All prices listed in catalog subject to change. Call for current prices.*

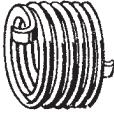
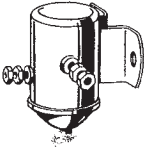
# Model B & V8 Parts 1932-1948

Part #	Description	Reqd.	Years	Price
<b>Starter</b>				
 52-11375	18-11002-6V Starter Motor. New with modern bendix 6 volt.	1		199.95 ea.
	18-11002-12V Starter Motor. New with modern bendix 12 volt.	1		199.95 ea.
 21A-11450	52-11375 Starter Drive Spring. 60 hp only.	1	1937-40	4.95 ea.
	21A-11450 Starter Solenoid Switch. Firewall mounted. Bakelite case.	1	1937-50	21.95 ea.
 6A-11500	48-11450 Starter Switch, Floor Mounted. Mounts between pedals under floorboards. Passenger & Commercial.	1	1935-36	29.95 ea.
	48-11450 Starter Switch, Floor Mount. Mounts between pedals under floorboards. Passenger & Commercial.		1935-36	29.95 ea.
	6A-11500 Starter Button, Dash Mount.	1	1937-48	6.95 ea.

## Wiring

18-11647	Head & Tail Lamp Wiring Set. Passenger & Commercial. Less cowl lights.	1	1932	39.50 set
40-11647	Head & Tail Lamp Wiring Set. Passenger & Commercial. Less cowl lights.	1	1933-34	39.50 set
48-11647	Head & Tail Lamp Wiring Set. Pass. & Comm.	1	1935-36	39.50 set
78-11653	Head & Tail Lamp Wiring Set. Light switch to headlamp & horn. Pass. & PU Truck.	1	1937	39.50 set
81A-11653	Head & Tail Lamp Wiring Set. Passenger Car.	1	1938	49.95 set
91A-11653	Head & Tail Lamp Wiring Set. Dimmer switch to H/L & horn relay.	1	1939	49.95 set
01A-11653	Head & Tail Lamp Wiring Set. Headlamps & horn relay. Pass., PU. & PU Std. Dlx.	1	1940	42.95 set
21A-11653	Headlamp & Horn Wiring Set. Pass. Car.	1	1941-47	44.95 set
51A-11653	Headlamp & Horn Harness. Passenger Car.	1	1947-48	18.95 set
18-14578	Conduit Set. Horn & headlamps. (3 pcs.) Fits 1932 Passenger & 1932-34 Pickup.	1		9.95 set

**Basic Numbers and Parts shown are for your assistance. Not all parts are available. Check parts list for numbers.**

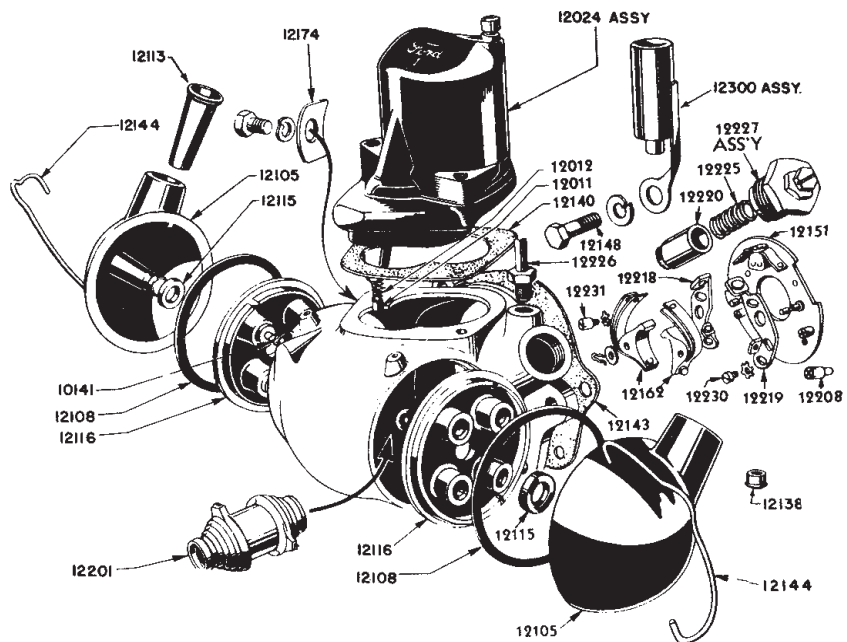

All prices listed in catalog subject to change. Call for current prices.

# Model B & V8 Parts

Part #	Description	Reqd.	Years	Price
<b>Ignition</b>				
68-12010	Coil to Distributor Contact Brush. Passenger & Commercial.	1	1936-41	4.50 ea.
78-12024	Ignition Coil. 2 screw mounting. Duplicate of original	1	1937-41	129.95 ea.
IGA-12024	Ignition Coil. Duplicate of original. Fits 6 cyl. 1941-47 & V-8 1942-48	1		129.95 ea.
18-12036-S	Coil Adapter Kit. Replaces original 3 screw coil. Uses A-12000-P or other 6 Volt coil NOT included in kit. V-8.	1	1932-36	49.95 ea.
78-12036-S	Coil Adapter Kit. Replaces original 2 screw coil. Uses A-12000-P or other 6 volt coil NOT included in kit. V-8.	1	1937-41	52.50 ea.
18-12104	Distributor Gasket Set. V-8. Pass. & Comm.	1	1932-41	5.95 set
21A-12104	Distributor Gasket Set. V-8.	1	1942-48	3.95 set
18-12105-B	Distributor Terminal Plate Cap. V-8. Passenger & Commercial.	2	1932-41	12.95 ea.
59A-12105	Distributor Outer Cap, V-8. Used with 59A-12106. Passenger & Commercial.	1	1946-48	24.95 ea.
59A-12106	Distributor Terminal Housing Inner Cap. V-8. Used with 59A-12105. Passenger & Commercial	1	1946-48	36.95 ea.
7RA-12106	Distributor Cap, V-8.	1	1949-56	8.95 ea.
21A-12106	Distributor Cap. Crab style.	1	1942-44	26.95 ea.
18-12107	Ignition Point Set. Long strip & 2 screw point style.	1	1932-36	24.95 set
78-12107	Ignition Point Set, Heavy Duty. (4 pc. set) Passenger & Commercial. Late 1936-48	1		19.95 set
18-12113	Weather Seal. Distributor to spark plug wire.	1	1932-41	3.50 pr.
18-12116	Distributor Terminal Plate, V-8. Passenger & Commercial	2	1932-36	24.95 ea.
68-12116	Distributor Terminal Plate, V-8. Pass. & Comm.	2	1936-41	24.95 ea.
B-12127	Distributor Assembly, Rebuilt. <i>Exchange Only.</i> Includes new cam, condenser & points. 4 cyl. (Order black rotor, cap & body if needed.)	1	1932-34	149.95 ex.
18-12138	Distributor Rubber Plugs. Fit bottom breaker point adjustment holes in distributor housing. Keeps dust and moisture out of points.		1932-41	3.25 pr.
21A-12144	Distributor Cap Bail Set. (4 pc. set) 6 cyl. 1941-42 & 8 cyl. 1942-48.	1		3.95 set
48-12200	Distributor Rotor, V-8.	1	1932-35	56.95 ea.
68-12200	Distributor Rotor, V-8.	1	1936-41	34.95 ea.
21A-12200	Distributor Rotor. 8 cyl. Pass. & Comm. (Use with #21A-12106-A).	1	1942-44	7.95 ea.
59A-12200	Distributor Rotor. 1946-56 V-8 & 1949-60 6 cyl	1		4.95 ea.
IGA-12200	Distributor Rotor. 6 cyl. G Series.	1	1941-47	2.95 ea.
01A-12250-C	Ignition Resistor & 15 Amp. Headlight Circuit Assy. Passenger & Commercial.	1	1938-40	29.95 ea.
18-12250	Ignition Resistor. Protects coil against overload. Passenger & Commercial.	1	1932-48	5.95 ea.
40-12250	Resistor/Fuse Terminal Block Assembly. Original style resistor & fuse assy.	1	1933-37	13.95 ea.
18-12259	Spark Plug Wire Set. Black cable w/ ring end terminals less metal conduits. Pass. & Comm.	1	1932-36	49.95 set



*Highest quality parts provided by our knowledgeable staff for your restoration needs.*

**All prices listed in catalog subject to change. Call for current prices.**

# Model B & V8 Parts 1932-1948

Part #	Description	Reqd.	Years	Price
<b>Ignition</b>				
78-12259	Spark Plug Wire Set w/ Terminal Ends. Color coded.	1	1937-41	49.95 set
59A-12259	Spark Plug Wire Set. Black with coil wire & terminals. V-8. 85/100 hp.	1	1946-48	84.95 set
B-12275	Spark Plug Connector Set. 3-3/4" long. Offset die stamped bronze. (4 pc. set)	1	1932-34	2.75 set
B-12300	Condenser, 4 cyl.	1	1932-34	10.95 ea.
18-12300-B	Condenser, V-8. Passenger & Commercial.	1	1932-36	8.95 ea.
78-12300	Condenser, V-8. Passenger & Commercial.	1	1937-41	12.95 ea.
81A-12300	Condenser Used w/ 81A-12024 Coil. Used late 1937 thru 1948.	1		8.95 ea.
IGA-12300-B	Condenser, 6 & 8 cyl. Pass. & Comm.	1	1942-48	8.95 ea.
40-12405	Spark Plug. 18 mm. 8 cyl. engines.	8	1933-37	4.25 ea.
7RA-12405	Spark Plug. 14 mm. 6 cyl. & V-8 engines.	8	1938-53	2.95 ea.
<b>Headlamps</b>				
48-13007-A	Headlamp Bulb. 50/32 cp. 6 Volt. Flanged base. Passenger & Commercial.	2	1935-39	1.95 ea.
01A-13007	Seal Beam Headlamp Bulb. 6 Volt.	2	1940-54	9.95 ea.
B-13028-A	Headlamp Reflectors. 2 bulb style. Passenger & Commercial.	1	1932	32.50 pr.
40-13028	Headlamp Reflectors. 2 bulb style. Passenger & Commercial.	1	1933-34	52.95 pr.
48-13028	Headlamp Reflectors. 2 bulb style. 1935-36 Passenger & 1935-39 Pickup.	1		48.50 pr.
78-13028	Headlamp Reflectors. 2 bulb style. Pass.	1	1937-39	48.50 pr.
B-13043	Headlamp Outer Rim. Stainless steel. (Order 2 if doing one vehicle)	1	1932	29.95 ea.
40-13043	Headlamp Outer Rim. Stainless steel. (Order 2 if doing one vehicle)	1	1933-34	29.50 ea.
78-13043	Headlamp Outer Rim. Stainless steel. (Order 2 if doing one vehicle)	1		29.50 ea.
91A-13043	Headlamp Outer Rim. Stainless Steel. (Order 2 if doing one vehicle.) Deluxe.	1	1939	29.50 ea.
B-13060	Headlight Lens. Ford script. Pass. & Comm.	2	1932	18.50 ea.
40-13060	Headlight Lens. Ford script. Pass. & Comm.	2	1933-34	18.50 ea.
48-13060	Headlight Lens, Ford Script. 1935 Passenger & 1935-39 Commercial	2		18.50 ea.
68-13060	Headlight Lens, Ford Script. Passenger	2	1936	18.50 ea.
78-13060	Headlight Lens, Ford Script. Passenger	2	1937	18.50 ea.
81A-13060	Headlight Lens, Ford Script. All 1938 & 1939 Standard.	2		18.50 ea.
91A-13060	Headlight Lens, Ford Script. Deluxe	2	1939	18.50 ea.
B-13076	Headlight Socket Assy. 2 Bulb Style. Passenger & Commercial.	1	1932	32.50 pr.
48-13076	Headlight Socket Assy. 2 Bulb Style. 1935-36 Passenger & 1935-39 Commercial.	1		32.50 pr.
B-13119-S	Headlight Bar Mounting Bolts. Angled head. Stainless Steel. 1932 Pass. & 1932-34 Comm.	2		14.95 pr.
40-13119-S	Headlamp Stand Hollow Mounting Bolts. S.S. 1933-34 Passenger & 1935-37 Commercial	2		12.95 pr.



48-13007-A



40-13060

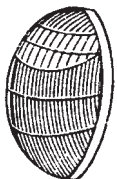

68-13060

All prices listed in catalog subject to change. Call for current prices.



# Model B & V8 Parts

Part #	Description	Reqd.	Years	Price
<b>Headlamps</b>				
18-13122	V-8 Emblem on headlamp cross bar.	1	1932	16.95 ea.
18-13130	Headlamp Bar to Fender Pads. 1932 Passenger & 1932-34 Pickup Truck.	1		3.95 pr.
40-13130	Headlamp Mounting Pads. 1933-34 Passenger & 1935-37 Pickup Truck.	1		3.95 pr.
48-13130	Headlamp Mounting Pads on Fender. Passenger Car Only	1	1935	3.95 pr.
68-13130	Headlamp Mounting Pads on Fender. Passenger Car Only	1	1936	3.95 pr.
8A-13532	Dimmer Switch w/Blade Type Terminals.	1	1941-48	7.95 ea.

## Cowl Lamps

B-13308	Cowl Lamp Lens, Glass. Pass. & Comm.	2	1932	6.95 ea.
B-13316	Cowl Light Lens Retainer Set. Passenger & Commercial. (4 pc. set)	1	1932-34	1.50 set

**Basic Numbers  
and Parts shown  
are for your  
assistance.  
Not all parts are  
available. Check  
parts list for  
numbers.**

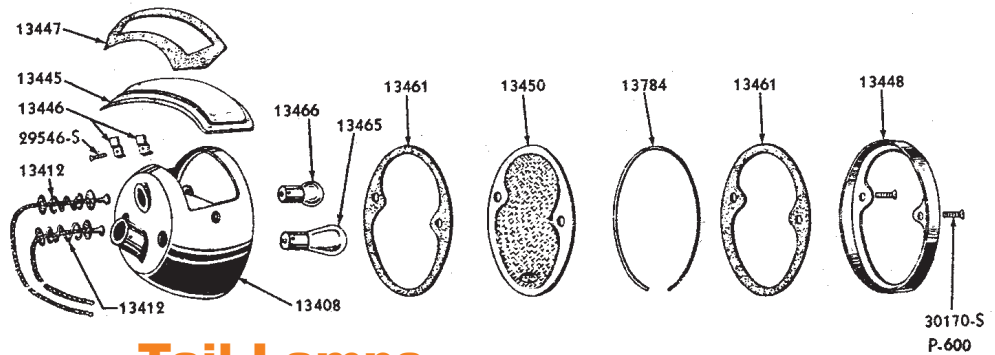

## Tail Lamps

B-13402-L	Tail Lamp Assembly. "Duolamp". Stainless steel. Authentic wire & loom. Left side.	1	1932	29.95 ea.
B-13402-R	Tail Lamp Assembly. "Duolamp". Stainless steel. Authentic wire & loom. Right side.	1	1932	29.95 ea.
40-13402-L	Tail Lamp Assembly. "Duolamp". Stainless steel. Authentic wire & loom. Left side.	1	1933-36	29.95 ea.
40-13402-LL	LED Tail Lamp Complete. Stainless steel w/Polycarbonate lens. (12 volt only)	1	1933-36	54.95 ea.
40-13402-LLC	LED Circuit Board, Left Hand. Use with existing tail light & lens. (12 volt only)	1	1933-36	34.95 ea.
40-13402-RL	Tail Lamp Complete, Right hand. Stainless steel w/Polycarbonate lens. (12 volt only)	1	1933-36	44.95 ea.
40-13402-RLC	Circuit Board, Right Hand. Use with existing tail light and lens. (12 volt only)	1	1933-36	24.95 ea.
40-13402-R	Tail Lamp Assembly. "Duolamp". Stainless steel. Authentic wire & loom. Right side.	1	1933-36	29.95 ea.
81A-13405	Tail Lamp Assembly. Authentic Wire & loom. Fits right or left. Passenger.	1	1938-39	29.95 ea.
81A-13405-L	12 Volt LED Tail Lamp Assembly. Fits left or right side.	1	1938-39	34.50 ea.
01A-13405	Tail Lamp Assembly. Fits right or left. All passenger cars except station wagons.	1	1940	29.95 ea.
21A-13405	Tail Lamp Assembly. Authentic wire loom. Fits right or left. Passenger Car.	1	1942-48	29.95 ea.

**All prices listed in catalog subject to change. Call for current prices.**

# Model B & V8 Parts 1932-1948

Part #	Description	Reqd.	Years	Price
<b>Tail Lamps</b>				
B-13405-LL	12 Volt LED Tail Lamp Assembly. Left Side. Polished stainless steel housing.	1	1932	44.95 ea.
B-13405-RL	12 Volt LED Tail Lamp Assembly. Right Side. Polished stainless steel housing.	1	1932	37.50 ea.
21A-13406	Universal Plate Bracket. Bolt to various vehicles, including trailers.	1	1937-on	4.95 ea.
B-13406-A	Rear License Bracket. "Duolamp". Pass.	1	1932	11.95 ea.
01A-13406-B	Rear License Plate Bracket. Fits on the trunk lid of Passenger Car.	1	1938-48	14.95 ea.
B-13406-C	Rear License Bracket. Stamped "Duolamp-B". Passenger & Pickup.	1	1933-36	11.95 ea.
40-13445	License Light Lens. Clear. 1933-36 Passenger & 1946-52 Pickup	1		4.95 ea.
B-13447	Tail Lamp Gasket Set. (3 pcs.)	1	1932	1.25 set
40-13447	Tail Lamp Gasket Set. (3 pcs.)	1	1933-36	1.95 set
81A-13448	Tail Lamp Rim, Stainless Steel.	1	1938-39	4.95 ea.
21A-13448	Tail Lamp Rim, Stainless Steel.	1	1942-48	8.95 ea.
B-13448-S	Tail Lamp Rim. Polished stainless. 1932 Passenger & 1932-42 Pickup	1		4.95 ea.
40-13448-S	Tail Lamp Rim. Polished stainless. 1933-36 Passenger & 1946-52 Pickup	1		4.95 ea.
B-13450	Tail Lamp Lens, Red Glass. 1932 Passenger & Comm., 1933-42 Comm.	1		6.95 ea.
40-13450	Tail Lamp Lens. Red glass. Passenger. Also 1942-48 Pickup.	1	1933-36	6.95 ea.
78-13450	Tail Lamp Lens, Red Glass.	1	1937	5.95 ea.
01A-13450	Tail Lamp Lens, Red Glass.	1	1940	6.95 ea.
11A-13450	Tail Lamp Lens, Red Glass.	1	1941	6.95 ea.
21A-13450	Tail Lamp Lens, Red Glass.	1	1942-48	6.95 ea.
91A-13450	Tail Lamp Lens, Red Glass.	1	1938-39	6.95 ea.
21A-13460	Tail light lens gaskets. The cork gaskets that fit between the glass lens & rim.	1	1942-48	1.50 pr.
40-13463	Tail Lamp Stand Brace. Either side. Fits underside of fender where tail lamp bracket bolts.	1	1933-34	19.95 ea.
11A-13465	Stoplight Bulb, 6 Volt, 21-3 cp. Double contact offset pins. For repro tail lamps. (Also 1938-48 genuine stop and tail lamps).		1938-48	1.00 ea.
40-13465	Tail Lamp Bulb. 21-3 cp DC 6 Volt. This bulb is designed for original tail lights used 1933-37. In line pins.	1	1933-37	1.10 ea.
11A-13465 /12V	Stop /Turn Signal Bulb. 12 Volt 32/3 cp. D.C. with offset pins. Used in 1932-48 repro tail lamp. (Also 1938-48 genuine stop & tail lamp).	1		1.00 ea.
40-13468	Tail Lamp Support Bracket. Reinforcement bracket used when a rumble seat step bracket is used. USA.	1	1933-34	5.95 ea.
40-13471	Tail Lamp Bracket. Mounts on fender. Stamped steel. Left or right. Passenger car.		1933-34	29.95 ea.
B-13471-L	Tail Lamp Bracket. Die formed steel. Driver's side. Passenger Car.	1	1932	32.00 ea.
B-13471-R	Tail Lamp Bracket. Die formed steel. Pass. side. Passenger Car.	1	1932	32.00 ea.



21A-13406

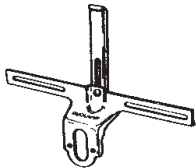

B-13406-A

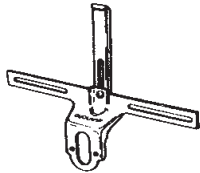

B-13406-C



21A-13448



11A-13465

All prices listed in catalog subject to change. Call for current prices.

# Model B & V8 Parts

Part #	Description	Reqd.	Years	Price
<b>Tail Lamps</b>				
11A-13480	Stop Lamp Switch, Hydraulic. Pass. & Comm.	1	1940-64	4.95 ea.
40-13520	Pads, Tail Lamp Stand on Fender.	1	1933-34	5.95 pr.
48-13520	Pads, Tail Lamp Stand on Fender.	1	1935	5.95 pr.
68-13520	Pads, Tail Lamp Stand on Fender.	1	1936	5.95 pr.
78-13520	Pads, Tail Lamp Stand to Fender.	1	1937	5.95 pr.
01A-13520	Pads, Tail Lamp Assy. to Fender. Deluxe.	1	1940	5.95 pr.
81A-13520	Pads, Tail Lamp Assy. to Fender.	1	1938-39	5.95 pr.
11A-13520	Pads, Tail Lamp Assy. to Fender.	1	1941	5.95 pr.
21A-13520	Pads, Tail Lamp Assy. to Fender.	1	1942-48	5.95 pr.
11A-13550	Deck Lid Handle Base w/ Hole for Light Socket. Die cast chrome.	1	1941-48	26.95 ea.
B-13769	Dome Lamp Switch. Original style dome lamp slide switch on pillar. See B-13770 for switch plate.( Also some 1937-48)	1	1932-36	9.95 ea.
B-13770	Dome Lamp Switch Cover Plate. Nickle plated. Use w/ B-13769.			2.95 ea.
B-13776	Dome Lamp Assembly. Less switch & plate. Closed Car.	1	1932-36	36.50 ea.
40-13809	Horn Vibrator Cover. Chrome plated brass.	1	1932-36	12.50 ea.
<b>Trunk Parts</b>				
99A-13550	Deck Lid Handle Base w/License Light. Die cast chrome. 1939 Mercury & 1940 Ford.	1		29.95 ea.
01A-13551	Deck Lid Handle & Base with Keys.	1	1940	69.95 ea.
11A-13551	Trunk Handle w/Lock Assembly & Keys. Less base lens and socket assembly.	1	1941-48	69.95 ea.
99A-13553	Deck Lid Handle Inner Base. Special cast inner base for #99A-13550. License light socket mounts in this. 1940 Ford & 1939 Merc.	1		7.50 ea.
11A-13562	Socket License Lamp Bulb & Wiring. Includes glass lens & socket with wiring & mounting hardware. Passenger.	1	1940-48	22.95 ea.
11A-13564	License Plate Lamp Glass Lens. Fits in deck lid base. 1940-48 Car only. (Also fits 1939-40 Mercury).	1	1940-48	5.95 ea.
11A-13572	Trunk Handle Base Mounting Pad.	1	1941-48	3.50 ea.
99A-13572	Mounting Pad for Trunk Handle Base on Trunk Lid. (Also fits 1939 Mercury)	1	1940	3.50 ea.
<b>Battery</b>				
18-14300	Battery to Starter Switch Cable. The cable from negative terminal to starter switch. 26.5" long.	1	1932-34	12.95 ea.
48-14300	Battery to Switch Cable. The cable from negative battery terminal to the starter switch.	1	1935-36	11.95 ea.
91A-14300	Battery to Solenoid Cable, 17"	1	1937-48	10.95 ea.
48-14301	Battery to Ground Cable. Braided flat cable (strap) solder dipped. 18" long.	1	1932-36	9.50 ea.
68-14301	Battery Ground Cable. Braided flat ground cable (strap). 11" long. Solder dipped. Passenger & Commercial. (also 8N Tractor-1938-48)	1	1935-36	10.95 ea.



01A-13551

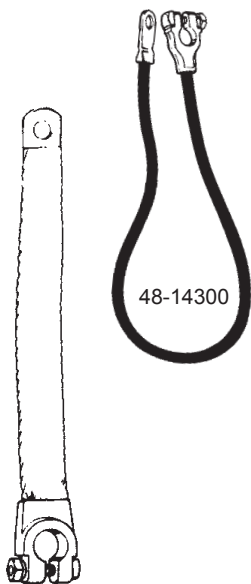

48-14300

48-14301

All prices listed in catalog subject to change. Call for current prices.

# Model B & V8 Parts 1932-1948

Part #	Description	Reqd.	Years	Price
<b>Battery</b>				
91A-14301	Battery to Ground Cable. Braided metal ground strap, solder dipped. 9" long.	1	1937-48	7.95 ea.
18-14431	Starter Cable. The cable from starter foot switch to starter motor.	1	1932-36	9.95 ea.
78-14431	Cable. Fits starter solenoid to the starter motor. 18" long.	1	1937-48	7.95 ea.
18-14578	Conduit Set. ( 3 pc.) Horn & headlamps. 1932 Passenger & 1932-34 Pickup Truck.	1		9.95 set
18-14578-T	Taillight Wiring Conduit Set. Flexible conduit w/ flared ends. 24" long. Used on pickup tail lamp wiring.	1	1928-55	9.95 set

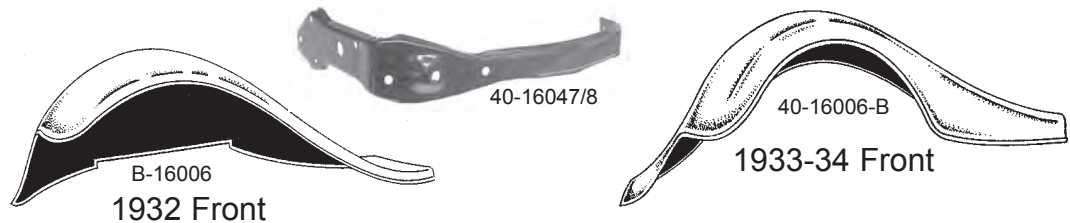

## Fenders & Brackets

B-16005	Front Fender. Stamped steel. Right side. Passenger & Commercial. Made in USA.	1	1932	600.00 ea.
46-16005	Front Fender, Right Side. Pickup & Commercial.	1	1933-34	495.00 ea.
40-16005-B	Front Fender. Stamped steel. Right side. Passenger Car. Made in USA.	1	1933-34	495.00 ea.
B-16006	Front Fender. Stamped steel. Left side. Passenger & Commercial. Made in USA.	1	1932	600.00 ea.
46-16006	Front Fender, Left Side. Pickup & Commercial.	1	1933-34	495.00 ea.
40-16006-B	Front Fender, Stamped steel. Left side. Passenger Car. Made in USA.	1	1933-34	495.00 ea.
B-16025	Front Fender Bracket. Stamped Steel. Passenger & Commercial.	2	1932	32.50 ea.
B-16031	Fender Well w/Drain Hole. 19 Gauge steel		1932	29.50 ea.
40-16047/8	Front Fender Large Heavy Braces. Die stamped steel. Passenger car only.	1	1933-34	79.95 pr.
40-16067	Support Bracket. For the heavy steel front fender braces, 40-16047/8. Passenger car only.	2	1933-34	7.95 ea.
48-16067	Support Brackets for Heavy Braces. Reinforcement brackets for right & left heavy front braces. Car & Pickup.	1	1935-39	17.95 pr.
11A-16079	"Super Deluxe" Front Fender Script. Fits on left front fender below headlight.	1	1941-42	14.95 ea.
51A-16079	"Super Deluxe" Front Fender Script. Block lettered logo. Fits on left fender below headlight. Die cast.	1	1946-47	14.95 ea.
40-16082/3	Inner Front Fender Aprons. Stamped steel. Improves air flow and reduce road grime in engine area. Passenger vehicles only.	1	1933-34	239.95 pr.
40-16094	Front Fender Brace at Rear of Fender. Right or left. Passenger Car.	2	1933-34	12.50 ea.

All prices listed in catalog subject to change. Call for current prices.



# Model B & V8 Parts

**Part # Description Req'd. Years Price**



## Fenders & Brackets

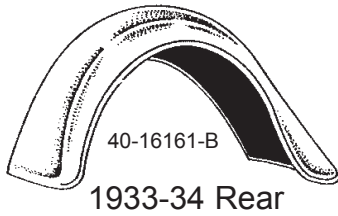
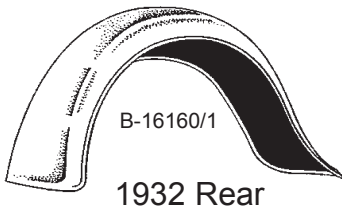

40-16396



B-16399

48-16094	Front Fender Brace at Rear of Fender. Passenger Car.	2	1935-36	24.95 ea.
50-16094	Front Fender Brace at Rear of Fender. Right or left. Comm. Vehicle & Pickup.	2	1935-37	24.95 ea.
B-16160/1	Rear Fenders. Stamped steel. Right & left side. Coupe & Roadster. Made in USA.	1	1932	1,000.00 pr.
40-16160-C	Rear Fender. Stamped steel. Right side. Coupe & Roadster. Made in USA.	1	1933-34	450.00 ea.
40-16161-B	Rear Fender. Stamped steel. Left side. Coupe & Roadster. Made in USA.	1	1933-34	450.00 ea.
B-16312-A/B	Rear Fenders. Stamped steel. Right and left side. Sedan & Phaeton. USA.	1	1932	1,100.00 pr.
40-16312-A	Rear Fender. Right (Pass.) Side. Stamped steel w/ correct beaded lip. Sedan & Phaeton.	1	1933-34	450.00 ea.
40-16312-B	Rear Fender. Left (driver's) side. Stamped steel w/ correct beaded lip. Sedan & Phaeton.	1	1933-34	450.00 ea.
48-16341	Rear Fender Brace. Right or Left. Passenger Car.	2	1935-36	24.95 ea.
78-16341	Rear Fender Brace. Right or left. Passenger Car.	2	1937-41	24.95 ea.
B-16345	Fender Welt. Black heavy drill. 1/4" x 25'.	1	1932-48	10.95 roll
40-16350	Chassis Webbing Kit. Treated cotton. 25'		1932-48	15.95 kit
40-16396	Gas Tank Cover. Die stamped with stock holes for rear bumper brackets and gas filler neck. Passenger Car only.	1	1933-34	349.95 ea.
40-16396-SR	Street Rod Style Gas Tank Cover. Center license 1 recess with or without stock holes as above. You specify. Passenger Car only.	1	1933-34	449.95 ea.
B-16399	Frame Horn Covers. Includes rubber seal & plugs.	1	1932	169.95 pr.
B-16450	Stock uncovered Running Boards. Only fits stock frame.	1		79.95 ea.
B-16450-BR	Running Board braces. Set of 4.	1		269.95 ea.
B-16450-R	Running Board Rubber Cover Set. This fully molded rubber cover set includes special adhesive and instructions. U.S.A. Passenger & Pickup.	1	1932	189.95 set
B-16450-SM	Smooth Running Boards.	1		269.95 ea.

All prices listed in catalog subject to change. Call for current prices.

# Model B & V8 Parts 1932-1948

Part #	Description	Reqd.	Years	Price
<b>Hood Trimming</b>				
18-16527	Radiator Splash Shield. Die formed. Passenger & Pickup.	1	1932	32.95 ea.
18-16527-CH	Chopped Radiator Splash Apron.	1		89.95 ea.
18-16527-MB	Front Radiator Apron Mounting Bolt Set. Original design mounts apron to frame and bumper braces.(18 pc. set)		1932	11.50 set
81C-16606	Hood Side Emblem, "Ford 85" in Oval. Commercial & Trucks.	2	1938-39	29.95 ea.
91A-16606	"Ford" Emblem. Fits 1939 hood & deck lid, 1940 Pickup hood & dash & 1940 Standard on hood.	2	1939-40	9.95 ea.
01A-16606-C				
01A-16606-C	Hood Emblem, "Ford". Deluxe Cars.	2	1940	9.95 ea.
91A-16607	Hood Emblem. "Deluxe." For driver's side of the hood only.	1	1939	9.95 ea.
01A-16607-C				
01A-16607-C	Hood Emblem, "Deluxe". Deluxe Car.	2	1940	9.95 ea.
6A-16607	Hood Center Ornament. Blue Plastic. Pass. car.	1	1947-48	14.95 ea.
18-16632	Center Hood Hinge. 32" long. Die formed stainless steel. Passenger Car.	1	1932	19.95 ea.
40-16632	Center Hood Hinge. 33" long. Die formed stainless steel. Passenger Car.	1	1933-36	19.95 ea.
B-16739-S	Radiator Shell Lacing Kit w/ Rivets. Passenger & 1932-34 Commercial.	1	1932	10.95 kit
40-16739-S	Radiator Shell Lacing Kit w/ Rivets. Pass.	1	1933-34	10.95 kit
48-16739-S	Radiator Shell Lacing Kit w/ Rivets. 1935 Passenger & 1935-37 Pickup	1		10.95 kit
68-16739-S	Radiator Shell Lacing Kit w/ Rivets. Pass.	1	1936	5.95 kit
B-16740-S	Cowl Lacing Kit w/ Rivets. Pass. & Comm.	1	1932	12.50 kit
40-16740-S	Cowl Lacing Kit. Passenger Car.	1	1933-34	9.95 kit
48-16740-S	Cowl Lacing Kit w/ Rivets. 1935 Passenger & 1935-37 Pickup	1		11.50 kit
68-16740-S	Cowl Lacing Kit w/ Rivets. Passenger.	1	1936	7.95 kit
78-16740-S	Cowl Lacing Kit. Rubber style. Fits 1937-40 Passenger, 1938-41 Pickup & 1949-51 Car.	1		6.95 kit
11A-16740-S	Hood Lacing Kit, Rubber. Passenger Car.	1	1941-48	6.95 kit
18-16750-S	Hood Latch Assembly. Stainless steel. 1932 Passenger & 1932-34 Commercial	4		16.95 ea.
B-16761-S	Hood Bumper Set. (12 pcs.) 1932 Passenger & 1932-34 Commercial	1		10.95 set
40-16761-S	Hood Bumper Set. Passenger Car. (14 pcs.)	1	1933-34	8.95 set
48-16761-S	Hood Bumper Set. 1935 Passenger & 1935-37 PU (16 pcs.)	1		13.95 set
68-16761-S	Hood Bumper Set. Passenger Car. (26 pcs.)	1	1936	13.95 set
78-16761-S	Hood Bumper Set. Passenger Car. (20 pcs.)	1	1937	12.95 set
81A-16761-S	Hood Bumper Set. (14 pcs.) Standard Passenger & Pickup	1	1938-39	8.95 set
91A-16761-S	Hood Bumper Set. For 1939 Deluxe & all Passenger Cars.		1939-40	8.95 set
11A-16761-S	Hood Bumper Set. Passenger Car. (12 pcs.)	1	1941-48	9.95 set



18-16527



01A-16606-C



01A-16607-C

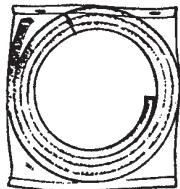

B-16739-S

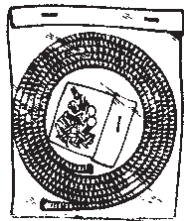

48-16739-S

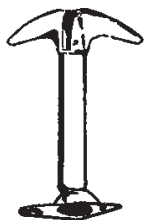

18-16750-S

All prices listed in catalog subject to change. Call for current prices.

# Model B & V8 Parts

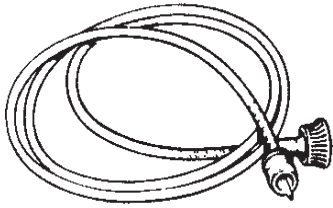

48-17260-S  
(A-17262)

*Highest  
quality parts  
provided  
by our  
knowledgeable  
staff for your  
restoration  
needs.*

Part #	Description	Reqd.	Years	Price
<b>Speedometer Cables</b>				
48-17260-S	Speedometer Cable & Housing. Passenger.	1	1935-48	19.95 ea.

Part #	Description	Reqd.	Years	Price
<b>Window Rubber</b>				
B-17430	Header Rubber. Pickup Truck.	1	1932-34	3.95 set
B-17432	Windshield Rubber Molding. Closed Car except 3-Window Coupe.	1	1932	19.95 set
40-17432	Windshield Rubber Molding. Open Car.	1	1932-36	4.95 set
46-17432	Windshield Rubber Molding. Pickup Truck.	1	1932-34	4.95 set
40-17434	Windshield Rubber Molding. 1933-34 Closed Car & 1932 3-Window Coupe	1		19.95 set
68-17436	Windshield Rubber Molding. Clo. Car & PU.	1	1935-36	19.95 set
78-17439	Windshield Rubber Molding. Clo. Car & PU.	1	1937-39	19.95 set
78-17440	Windshield Rubber Molding. Convertible. Station Wagon Cabriolet.	1	1937-40	67.95 set
01A-17440	Windshield Rubber Molding. 1940 Closed Car & 1940-47 Pickup Truck	1		49.95 set
21A-17440-A	Windshield Rubber Molding. For Closed Car without chrome center windshield strip.	1	1941-48	48.95 set
21A-17440-B	Windshield Rubber Molding. For Closed Car with chrome strip. (Ford & Mercury).	1	1941-48	48.95 set
21A-17440-C	Windshield Rubber Molding w/ Groove for Strip. Convertible. (Ford or Mercury).	1	1941-48	48.95 set
01A-17441	Vent Window Rubber Set. Coupe & Sedan.	1	1940	36.95 set
21A-17441	Vent Window Rubber Set. Closed Car & Wagon. (Ford & Mercury).	1	1941-48	42.95 set
01A-17442	Vent Window Rubber Set. Ford Convertible only.	1	1940	39.95 set
21A-17442	Vent Window Rubber Set w/Rubber Trim Strips. Convertibles. (Ford & Mercury).	1	1941-48	39.95 set
B-17450	Rear Window Glass Rubber. 1932-36 Closed Car & 1932-34 Pickup			5.95 set
78-17450-S	Rear Window Glass Rubber. All '37 & '38 Std. Sedans & 1938-40 Coupes.	1		21.95 pr.
81A-17450-D	Rear Window Glass Rubber. Sedans, Ford & Mercury. 1938 Dlx. Only & All 1939-40			21.95 pr.
11A-17450	Rear Window Glass Rubber Set for Closed Car without Chrome Strip on Rear Frame.	1	1941-48	24.95 set
11A-17450-B	Rear Window Glass Rubber Set for Closed Car with Chrome Strip. (Ford & Mercury).	1	1941-48	24.95 set
01C-17451	Rear Window Glass Rubber. Pickup Truck.	1	1940-47	24.95 set
B-17455	Quarter Window Rubber. Coupe.	1	1932-41	8.95 set

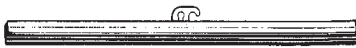

21A-17528

Part #	Description	Reqd.	Years	Price
<b>Windshield Wipers</b>				
21A-17528	Windshield Wiper Blade. 9" long. Fits vacuum wipers. Hook style. Pass. & Comm.		1941-48	4.95 ea.
78-17529-A	Windshield Wiper Arm. Stainless steel. Coupe, Sedan & Commercial.		1937-39	14.95 ea.
01A-17529	Windshield Wiper Arm. Stainless steel. 1937- 40 Open Car & All 1940 Passenger.			14.95 ea.
21A-17529-L	Windshield Wiper Arm. Fits vacuum wipers. Left side. Stainless. All bodies except Pickup.	1	1941-48	14.95 ea.

All prices listed in catalog subject to change. Call for current prices.

# Model B & V8 Parts 1932-1948

**Part # Description Req'd. Years Price**

## Windshield Wipers

21A-17529-R	Windshield Wiper Arm. Fits vacuum wipers. Right side. Stainless. All bodies except Pickup.	1	1941-48	14.95 ea.
-------------	--	---	---------	-----------

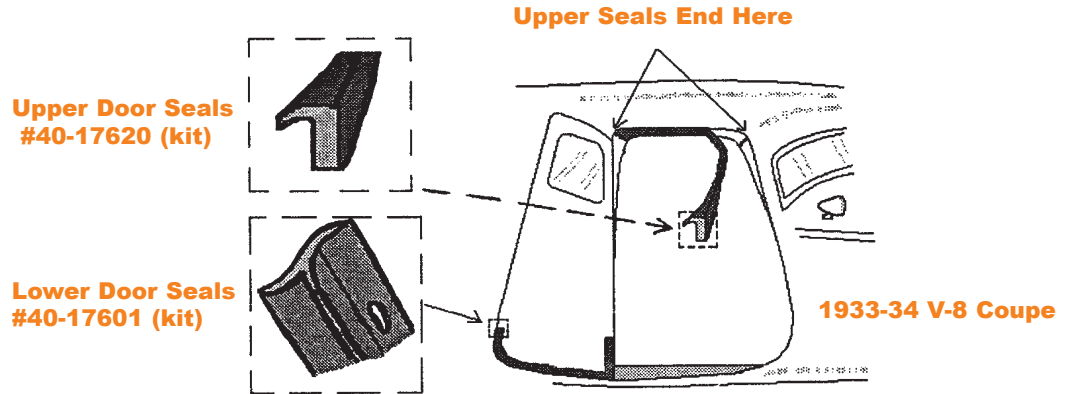

## Seal Kits

B-17600	Lower Door Seal Kit. For both doors. Roadster.	1	1932	9.95 kit
B-17600-P	Lower Door Seal Kit. For all doors. Phaeton.	1	1932	9.95 kit
40-17601	Lower Door Seal Kit. For all doors. All Closed Cars, 1933-34 Open Cars, & 1935-36 Pickup.	1		19.95 kit
46-17601	Lower Door Seal Kit. For both doors. Fits 1932-34 & 1937-47 Closed Cab Pickup. (Should also fit large Trucks)	1		9.95 kit
48-17603	Lower Door Seal Kit. For all doors. Fits Coupe, Tudor and Roadster.	1	1935-36	18.95 kit
48-17604	Lower Door Seal Kit. Fits all 4 doors. Open and Closed Car.	1	1935-36	18.95 kit
78-17604	Lower Door Seal Kit. Fits all Open & Closed Cars.	1	1937	18.95 kit
78-17605	Lower Door Seal Kit. Fits all 4 doors. Open and Closed Car.	1	1937-48	18.95 kit
81A-17605	Lower Door Seal Kit. Fits all Passenger Cars, Tudor or Fordor.	1	1938-39	16.95 kit
01A-17606	Lower Door Seal Kit. Fits all 2 or 4 door Cars.	1	1940	16.95 kit
11A-17607	Lower Door Seal Kit. Fits all Passenger Cars including Fordor, Open or Closed.	1	1941-48	16.95 kit
40-17620	Upper Door Seal Kit. For both doors. Coupe, Tudor, & 1932 3/W Coupe.	1	1933-34	12.95 kit
40-17621	Upper Door Seal Kit. For all four doors. Fordor Sedan.	1	1933-34	14.95 kit
48-17622	Upper Door Seal Kit for both doors. Coupe & Tudor.	1	1935-36	12.95 kit
48-17623	Upper Door Seal Kit for all four doors. Fordor Sedan.	1	1935-36	14.95 kit
78-17625	Upper Door Seal Kit. Coupe & Tudor Sedan.	1	1937-48	12.95 kit
78-17626	Upper Door Seal Kit. Fordor Sedan.	1	1937-48	14.95 kit
40-17650	Rumble or Trunk Lid Rubber Seal Set. Open & Closed Car.	1	1932-34	12.95 set
48-17652	Trunk Lid Rubber Seal Set. Coupe, Cabriolet and Roadster.	1	1935-36	14.95 set

All prices listed in catalog subject to change. Call for current prices.



# Model B & V8 Parts

Part #	Description	Reqd.	Years	Price
<b>Seal Kits</b>				
48-17653	Trunk Lid Rubber Seal Set for Humpback Style Sedans.	1	1935-36	22.95 ea.
48-17654	Rumble Lid Rubber Seal Set. Coupe, Cabriolet & Roadster.	1	1935-39	14.95 set
78-17656	Trunk Lid Rubber Seal Set. The hollow core design provides positive seal. 1937-40 Passenger & 1941- 48 Coupe & Convertible.			22.95 set
21A-17660	Trunk Lid Rubber Seal Set. 1 piece. Tudor & Fordor Sedan.	1	1941-48	29.95 set



1932 Passenger & Commercial Bumper



1934 Passenger & Sedan Delivery & Station Wagon

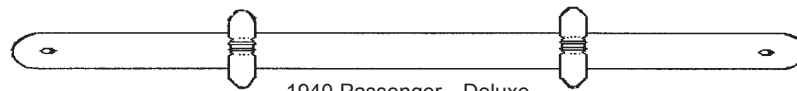

1940 Passenger—Deluxe

## V-8 Bumpers (1932-40)

We offer Bumpers in Chrome or Stainless Steel, Front and Rear. For Passenger or Commercial Vehicles.

Please Specify the following Requirements: Year of vehicle; Passenger or Commercial Front or Rear bumpers; Standard or Deluxe.

Be sure to order your Bumper Brackets... State your vehicle's exact year when ordering.

18-17752-C	Bumper Bar. Front or rear. Chrome plated. The unique ribbed bumper for Passenger & Commercial Vehicles.	1	1932	349.95 ea.
40-17754-C	Bumper Face Bar. Front or rear. Chrome plated. Passenger Car only.	1	1933	349.95 ea.
40-17754-S	Bumper Face Bar. Front or rear. Stainless steel. Passenger Car.	1	1933	410.00 ea.
40-17757-C	Bumper Face Bar. Front or rear. Chromed. Passenger Car.	1	1934	349.95 ea.
40-17757-S	Bumper Face Bar. Front or rear. Stainless steel. Passenger vehicle.	1	1934	410.00 ea.
48-17757-C	Bumper Face Bar. Front or rear. Chromed. Passenger Vehicle.	1	1935	349.95 ea.
48-17757-S	Bumper Face Bar. Front or rear. Stainless steel. Passenger Vehicle.	1	1935	410.00 ea.
68-17757-C	Bumper Face Bar. Front or rear. Chrome plated. Passenger Vehicle.	1	1936	349.95 ea.
68-17757-S	Bumper Face Bar. Front or rear. Stainless steel. Passenger.	1	1936	410.00 ea.
78-17757-C	Bumper Face Front Bar. Chromed. Pass. Also front or rear Commercial.	1	1937	349.95 ea.

All prices listed in catalog subject to change. Call for current prices.

# Model B & V8 Parts 1932-1948

**Part # Description Req'd. Years Price**

## V-8 Bumpers (1932-40)

We offer Bumpers in Chrome or Stainless Steel, Front and Rear. For Passenger or Commercial Vehicles.

Please Specify the following Requirements: Year of vehicle; Passenger or Commercial Front or Rear bumpers; Standard or Deluxe.

Be sure to order your Bumper Brackets... State your vehicle's exact year when ordering.

78-17757-CR	Bumper Face Bar. Rear only. Chromed. Passenger.	1	1937	349.95 ea.
78-17757-S	Bumper Face Bar. Front only. Stainless steel. Passenger Car.	1	1937	410.00 ea.
78-17757-SR	Bumper Face Bar. Rear only. Stainless steel. Passenger Car.	1	1937	410.00 ea.
81A-17757-C	Bumper Face Bar. Front or Rear. Chromed. Standard Car & Commercial.	1	1938	349.95 ea.
81A-17757-S	Bumper Face Bar. Front or rear. Stainless steel. 1938 Deluxe Car & 1939 Standard Car.	1		410.00 ea.
91A-17757-C	Bumper Face Bar. Front or rear. Chromed. 1939 Standard Car & 1938 Deluxe Car. (Also 1939 Pickup Front.)	1		349.95 ea.
91A-17757-CD	Bumper Face Bar. Front or rear. Chromed. Deluxe Passenger Car.	1	1939	349.95 ea.
01A-17757-C	Bumper Face Bar. Front or rear. Chromed. Passenger Car. Also Commercial Front. (Length oa 65-1/2")	1	1940	349.95 ea.
18-17758	Bumper Face Bar Bolt. Stainless steel. Pass.	2	1932	10.95 ea.
40-17758	Bumper Face Bar Mounting Bolt. Oval w/ stainless steel cover. Pass. & Comm.		1933-40	6.95 ea.
18-17760	Bumper Bar End Plug. Stainless steel. (Used on upper end only).	2	1932	3.95 ea.
18-17766	Bumper Brackets. Front or rear. Specify which one. (Set of 2 pcs.) Passenger.	1	1932	64.95 set
40-17766	Bumper Braces. Front only. (4 pc. set).	1	1933-40	129.95 set
48-17772-S	Front Bumper Arm Grommets. Passenger Car.	1	1935	9.95 pr.
50-17772-S	Front Bumper Arm Grommets. Comm. Vehicle.	1	1935-37	9.95 pr.
68-17772-S	Front Bumper Arm Grommets. Fits all 1936-37 Passenger & 1938 Standard.	1		9.95 pr.
81A-17772-S	Front Bumper Arm Grommets. Passenger Car: 1938 Deluxe & 1939 Standard.	1		9.95 pr.
40-17787	Bumper Brackets. Rear. Passenger. (2 pc. set)	1	1933-36	54.95 set
01A-17787	Bumper Brackets. Rear. (4 pcs.) Specify Year.	1	1937-40	124.95 set
81C-17792-S	Front Bumper Arm Grommets. Comm.	1	1938-39	9.95 pr.
91A-17792-S	Front Bumper Arm Grommets. 1939-40 Deluxe Car & 1940-41 Commercial.	1		9.95 pr.
11A-17792-S	Front Bumper Arm Grommets. Passenger Car.	1	1941	9.95 pr.
78-17793-S	Rear Bumper Arm Grommets. All 1937 & 1938-40 Coupe & Convertible	1		9.95 pr.
81A-17793-S	Rear Bumper Arm Grommets. Tudor & Fordor Sedan.	1	1938-40	9.95 pr.
11A-17793-S	Rear Bumper Arm Grommets. Passenger Car.	1	1941	9.95 pr.

All prices listed in catalog subject to change. Call for current prices.



40-17758



18-17758



18-17760

# Model B & V8 Parts

Part #	Description	Reqd.	Years	Price
<b>V-8 Bumpers (1932-40)</b>				
40-17796-B	Round Head Bumper Guard Bolt. Used with the 40-17996 bumper guard. Solid stainless steel.	2	1933-34	6.95 ea.
01A-17996	Bumper Guard. Front or rear. Chrome. (2 per bumper).	2	1940	32.50 ea.
40-17996	Bumper Upright Guard. Front or rear. Chromed with black painted centerline. (2 per bumper).	2	1933-34	21.95 ea.
68-17996	Bumper Guard. Chrome. Front or rear. Passenger. (2 per bumper).	2	1935-36	48.95 ea.
78-17996	Bumper Guard, Front or rear. Chromed. (1 pr. needed per bumper).	1	1937	118.95 pr.
<b>Vent Seals</b>				
18-17900	Cowl Vent Seal. Now with inner lip seal. 1932 Passenger & 1932-34 Pickup	1		12.95 ea.
40-17900	Cowl Vent Seal. Now with inner lip seal. 1933-34 Passenger & 1935-36 Commercial	1		12.95 ea.
48-17900	Cowl Vent Seal. Passenger Car.	1	1935-36	12.95 ea.
91A-17900	Cowl Vent Seal. For 1937-48 Passenger and 1937-47 Pickup.	1		13.95 ea.
<b>Shock Absorbers</b>				
40-18055	Shock Link. Passenger & Commercial.	4	1934-35	6.95 ea.
48-18055	Shock Link. 3" center to center. Passenger & Commercial	4	1935-40	15.95 ea.
78-18055	Shock Link. 4" center to center. Passenger & Commercial	4	1937-38	16.95 ea.
99A-18055	Shock Link. 4-3/4" center to center. Pass.	4	1941-47	18.95 ea.
21A-18055	Torsion Bar Link. 2.39" center to center. Passenger Car.	2	1942-48	15.95 ea.
<b>Mirrors</b>				
18-18400	Inside Mirror Assembly. Stainless steel. Open Car.	1	1932	34.50 ea.
40-18400	Inside Mirror Assembly. Stainless steel. Open Car.	1	1933-36	34.50 ea.
18-18402	Inside Mirror. Stainless steel. Closed Car. Passenger & Commercial.	1	1932-36	34.50 ea.
46-18403	Hinge Mirror, Right or left. Pickup Truck.	1	1932-34	38.50 ea.
48-18403	Hinge Pin Mirror. Curved arm style. Pass. Fits Left or Right Side. (Also 1948-52 PU)	1	1935-40	36.95 ea.
50-18403	Hinge Pin Mirror for Pickup Truck. Fits either side.	1	1935-47	36.95 ea.
78-18414	Peep Mirror. Fits top door edge, left or right. Curved arm 4" Head. Promotes safety.	1	All	17.95 ea.
48-18416	Locking Gas Cap, Ford Script. Has spring loaded stainless cover with Ford script & 2 keys. Passenger & Pickup.	1	1932-48	29.95 ea.
78-18420	Door Edge Mirror, Nostalgic style. The die cast 6-1/2" arm with 4" stainless mirror head allows for fully adjustable rear viewing. Fits left or right hand. Fits most years.	1		16.95 ea.

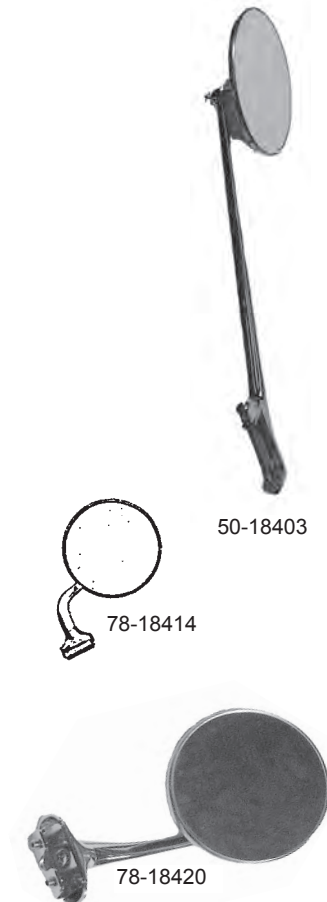

All prices listed in catalog subject to change. Call for current prices.

# Model B & V8 Parts 1932-1948

**Part # Description Req'd. Years Price**

## Glove Boxes

All Passenger Car boxes are lined, water repellent exterior and include mounting hardware as required.

All Commercial boxes are water repellent cardboard and include mounting hardware as required.

40-18700	Glove Box. Fits all Passenger Cars.	1	1933-34	14.50 ea.
48-18700	Glove Box. Fits Open Car.	1	1935-36	14.50 ea.
68-18700	Glove Box. Closed Car.	1	1935-36	14.50 ea.
78-18700	Glove Box. Fits all except Commercial.	1	1937	14.50 ea.
81A-18700	Glove Box. Fits Open Car.	1	1938-39	14.50 ea.
91A-18700	Glove Box. Closed Car.	1	1938-39	14.50 ea.
01A-18700	Glove Box. Fits all except Commercial.	1	1940	14.50 ea.
11A-18700	Glove Box. Fits all except Commercial.	1	1941	14.50 ea.
21A-18700	Glove Box. Fits Ford only.	1	1942-48	14.50 ea.
59A-18700	Glove Box. Fits Mercury only.	1	1941-48	14.50 ea.
48C-18710	Glove Box. Commercial Vehicle.	1	1935-37	14.50 ea.
81C-18720	Glove Box. Commercial Vehicle.	1	1938-39	14.50 ea.
01C-18730	Glove Box. Commercial Vehicle.	1	1940-47	14.50 ea.
8C-18740	Glove Box. Commercial Vehicle.	1	1948-52	14.50 ea.

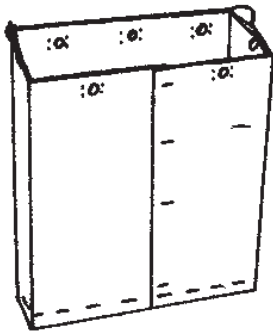

## Door Handles

40-19001	Door Dovetail w/ Screws. Female. Stainless steel. Open Car.	1	1932-36	24.50 pr.
40-19002	Door Dovetail. Female. Stainless steel. Closed Car, Cabriolet & Pickup.		1932-36	29.95 pr.
40-19003	Door Dovetails w/ screws. Male. Stainless steel. Open Car.		1932-36	12.95 pr.
18-19004	Door Dovetails, Male. Stainless steel w/ screws. 1932 Closed Vehicles & 1932-34 Pickup			12.95 pr.
18-19004/3W	Door Striker Plate w/Slot Head Screws. Polished S.S. 3 Window Coupe. (Also 1933-34 Sedan Delivery)	1	1932	22.50 set
40-19004	Door Striker Plate. Polished stainless w/ screws. Closed Car & Pickup.		1932-34	12.50 ea.
01A-19004	Door Striker Plate. Chrome Plated. 1940 Passenger & 1941-48 Station Wagon			8.95 ea.
81A-19004	Door Striker Plate w/ Screws. Stainless steel. 1935-39 Closed Car & 1935-52 Pickup.			10.95 ea.
11A-19004	Door Striker Plate. Chrome plated. Passenger.		1941-48	8.95 ea.
40-19005	Door Dovetails w/ screws. Male. Stainless steel. 1933-40 Closed Car & 1935-41 Pickup.			12.95 pr.
11A-19005	Door Dovetail. Male. Stainless steel w/ screws. 1941-48 Cars & 1942-52 Pickup.			12.95 pr.
18-19015	Heavy Duty Window Regulator. With hardened drive gear for a smooth roll-up. Mounting hardware. Right side. Coupe & Sedan.		1932-33	64.95 ea.
40-19015	Heavy Duty Window Regulator Assembly. As above. Right side. Fits 1934 Coupe & Sedan and 1935-36 left side rear quarter.			64.95 ea.
18-19016	Heavy Duty Window Regulator as above. Left side. Coupe & Sedan.		1932-33	64.95 ea.



40-19002



81A-19004

All prices listed in catalog subject to change. Call for current prices.

# Model B & V8 Parts

Part #	Description	Reqd. Years	Price
<b>Door Handles</b>			
B-19077	Door Striker Plate & Screws. Stainless steel. Open Car. (1 per door)	1928-32	9.95 ea.
40-19077	Door Striker Plate w/ Screws. Open Car. (1 per door)	1933-36	24.95 ea.
18-19101	Inside Door Opener. Closed Pass. Car.	1932	10.95 ea.
40-19101	Inside Door Handle. Chrome plated. Closed Car.	1933-34	9.95 ea.
46-19101	Inside Door Handle. Chrome plated. Comm. Vehicle.	1932-34	10.95 ea.
48-19101	Inside Door Handle. Chromed. Closed Car & Truck.	1935	10.95 ea.
68-19101	Inside Door Handle. Chrome Plated. 1936 Closed Car & 1936-37 Pickup		10.95 ea.
01A-19101	Inside Door Handle. Chromed. Dlx. Pass.	1940	9.95 ea.
11A-19103	Inside Door Handle. Chromed. Pass Car.	1941-48	10.95 ea.
18-19108	Window Riser Handle. Passenger Car.	1932	11.50 ea.
40-19108	Window Riser Handle. Chrome plated. Closed Car.	1933-34	11.95 ea.
46-19108	Window Riser Handle. Chromed. Comm. Vehicle.	1932-34	9.95 ea.
48-19108	Window Riser Handle. Chromed. Closed Car & Truck.	1935	9.95 ea.
68-19108	Window Riser Handle. Chrome Plated. 1936 Passenger Car & 1936-37 Comm.		9.95 ea.
01A-19108	Window Riser Handle. Chromed. Deluxe Car.	1940	9.95 ea.
11A-19108	Window Riser Handle. Chromed. Pass. Car.	1941-48	9.95 ea.
B-19110-S	Escutcheon Plate Spring. Coned spring that fits behind door panel to hold tension on the escutcheon plate.	1924-48	.50 ea.
B-19111	Escutcheon Plate for Door Handle & Window Crank. Stainless steel. Closed Car.	1932	3.95 ea.
40-19111-C	Escutcheon Plate for Door Handle & Window Crank. Stainless steel. Closed Car.	1933-34	4.95 ea.
40-19111-O	Escutcheon Plate. Stainless steel. Open Car.	1933-34	3.95 ea.
46-19111	Escutcheon Plate. Stainless steel. Comm. Vehicle.	1932-34	3.95 ea.
48-19111	Escutcheon Plate. Stainless steel. Open Car.	1935-36	3.95 ea.
68-19111	Escutcheon Plate. Stainless steel. Closed Car & 1935-37 Commercial.	1935-36	3.95 ea.
40-19112	Windshield Roll-out Handle. Closed Car.	1 1933-34	8.95 ea.
40-19114/ 15-KA	Outside Locking Door Handles. Keyed alike. Super chrome & detail. Flat base. 4 keys. Fits 1932 3/W Coupe & Cabriolet & 1933-34 Closed Car.	1	69.95 pr.
B-19114-L	Outside Door Handle. Curved base. Left side. Closed Car except 3 Window Coupe.	1932	24.95 ea.
B-19115-R	Outside Door Handle. Curved base. Right side. Closed Car except 3 Window Coupe.	1932	24.95 ea.
40-19116-L	Outside Door Handle. Flat base, Left side. 1933-34 Closed Car. (Also 1932 3/W Coupe & Cabr.)		26.95 ea.
40-19117-R	Outside Door Handle. Flat base. Right side. 1933-34 Closed Car. (Also 1932 3/W Coupe & Cabr.)		26.95 ea.
46-19118	Outside Door Handle. Chrome plated. Closed cab Truck.	1932-34	26.95 ea.
48-19118	Outside Door Handle. Passenger Car.	1935	24.95 ea.
50-19118	Outside Door Handle. Pickup & Commercial.	1935-36	26.95 ea.



All prices listed in catalog subject to change. Call for current prices.

# Model B & V8 Parts 1932-1948

Part #	Description	Reqd.	Years	Price
<b>Door Handles</b>				
68-19118	Outside Door Handle, Curved handle. Chromed. 1936 Deluxe Car & 1937 Pickup.			24.95 ea.
78-19118	Outside Door Handle. Chromed. Passenger Car.		1937	24.95 ea.
81A-19118	Outside Door Handle. Chromed. 1938 Standard Passenger & 1938-47 Pickup			26.95 ea.
81A-19119	Outside Door Handle. Chrome. Deluxe Car.		1938	24.95 ea.
91A-19119	Outside Door Handle. Chrome. Passenger Car.		1939	24.95 ea.
11A-19119	Outside Door Handle. Chrome. Passenger Car.		1941	24.95 ea.
51A-19119	Outside Door Handle. Chrome. Passenger Car. 1946 - early 1947.			24.95 ea.
6A-19119	Outside Door Handle. Chrome. Passenger Car.		late 1947-48	24.95 ea.
01A-19119	Outside Door Handle. Chromed. Pass. Car.		1940	26.95 ea.
B-19170	Hinge Pin. Black oxide finish. 9/32 dia. 2-5/16 long. Passenger & Commercial.		1932-48	1.00 ea.
B-19170-SS	Hinge Pin. Polished stainless steel. 9/32 dia. 2-1 1/16" long. Can be shortened for some body styles. Passenger & Commercial.		1932-48	2.95 ea.
<b>Truck Parts</b>				
TK-3	Dispatch Pocket w/Mounting Hardware. Fits on passenger side kick panel. Also used for maps.	1	1930-34	22.95 ea.
TK-15	Window Regulator Assembly. Right Side. Closed Cab Truck.	1	1928-34	36.50 ea.
TK-16	Window Regulator Assembly. Left Side. Closed Cab Truck.	1	1928-34	36.50 ea.
TK-18	Door Bottom Patch Panels. Closed Cab Truck & Pickup.	1	mid '30-31	74.95 ea.
TK-43	Inside Rear Window Frame.	1	6/30-34	79.50 ea.
TK-45	Mud Shield. Fits at rear of the tail light & protects the wiring from mud.	1	1929-48	4.95 ea.
TK-47	Tail Light Bracket. V-8 Pickup.		1929-37	7.95 ea.
TK-55	Tailgate Chain Hook. Authentic gauge and shape. State year 1926-37 or 1938-52.			5.25 ea.
TK-56	Tailgate Hook Retainer Springs.	1	1938-50	8.25 pr.
TK-57	Tailgate Chain. Authentic gauge. (16 links)	2	1931-37	3.75 ea.
TK-58	Tailgate Chain. Authentic gauge & style links. (13 links)	2	1938-52	4.25 ea.
TK-60	Tailgate Chain Cover. Black authentic grained material.	2	1926-37	3.95 ea.
TK-62	Tailgate Chain Top Link. Rolled iron. Must be welded to fit.	2	1926-37	2.95 ea.
TK-63	Tailgate Chain Top Link. Cast steel. Must be welded to fit.	2	1938-50	9.95 ea.
TK-64	Tailgate Chain Bracket. Stamped steel. Rivets to PU box sides.	2	1931-37	8.25 ea.
TK-65	Tailgate Chain Bracket. Stamped Steel. Rivets to Pickup Box Sides.	2	1938-50	5.95 ea.
TK-68	Tailgate Hinge Set. Stamped steel & drilled. (Set of 3)	1	1931-36	13.95 set
TK-79	Pickup Wagon Box Rivets. (Set of 4)	1	1926-39	.95 set



6A-19119



01A-19119



TK-43



TK-55



TK-62

All prices listed in catalog subject to change. Call for current prices.

# Model B & V8 Parts



FORD HAT

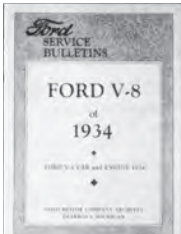

VB-6



VB-7

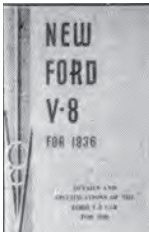

VB-8



VB-10-A



VB-10-B



VB-10-C



VB-11

Part #	Description	Reqd. Years	Price
FORD-HAT	Adjustable Ford Baseball Hat	1	8.95 ea.
V8-HAT	Adjustable Ford Model V8 Baseball Hat	1	8.95 ea.
HP-27	Hat Pin/Quail Cap.	1	5.00 ea.

## Model B & V8 Extras

## V-8 Ford Books

VB-1	<b>1932 Ford Restorer's Guide</b> A guide to the V-8 and 4 cylinder car on interior, exterior and mechanical servicing of car. 20 pages.....		\$8.95
VB-2	<b>1932 Service Instruction</b> Covers both 4 & 8 Cyl. 88 pages.....		\$11.95
VB-3	<b>1933 Ford Restorer's Guide</b> A guide such as VB-1 except for the 1933 model year also giving exterior-interior and etc. 29 pages. 15 illustrations.....		\$8.95
VB-4	<b>1933 Ford Service Bulletins</b> This is the reprinted compilation of the company service bulletins on the changes over 1932. 88 pages, 64 illustrations.....		\$11.95
VB-5	<b>Restorer's Guide for 1934</b> Details & specifications. 59 pages, 8 illustrations.....		\$6.95
VB-6	<b>Ford Service Instructions 1934</b> Company bulletins to guide dealers and service men through the changes as made in the 1934 car & engine. 103 pgs., 51 illustrations.....		\$10.95
VB-7	<b>Restorer's Guide for 1935</b> Details & specifications & lists the improvements made with new body & frame. 64 pages, 8 illustrations.....		\$6.95
VB-8	<b>Restorer's Guide for 1936</b> Details & specifications for mechanical and body. 64 pages, 10 illus.....		\$6.95
VB-9	<b>Ford Maintenance Manual 1932-48</b> To help owners keep their cars running during World War II shortages. Issued by the company. 64 pages, 36 illustrations.....		\$8.95
VB-10	<b>Repair Manual, Ford &amp; Mercury V-8 Engines, 1937-48</b> Illustrations & instructions for the repair of these two Ford Engines. 64 pages, 61 illustrations.....		\$11.95
VB-10-A	<b>Repair Manual, Generating &amp; Starting Systems 1933-47</b> This repair manual covers the generators & starters used on the V-8's from 1933-47. 42 pages.....		\$7.95
VB-10-B	<b>Repair Manual, Fuel System</b> This repair manual covers the carburetors and fuel pumps used on the V-8's from 1938-48. 60 pages.....		\$7.95
VB-10-C	<b>Repair Manual, Transmission/Clutch, Overdrives &amp; Power Take-offs. 1932-47 V-8's</b> 80 pages.....		\$7.95
VB-10-H	<b>Hardware &amp; Trim Book 1928-34</b> Over 600 illustrations, and body types cross-indexed. Dealers found this book valuable when ordering parts. 8 1/2 x 11.....		\$7.95
VB-10-KD	<b>KD Valve Service Tool Box (All years)</b> .....		\$7.95
VB-11	<b>Body Parts List, V-8 &amp; 4 Cylinders 1932</b> Twenty body photos of Model B passenger cars which were identical for both 4 cyl. and V-8 cars. Gives body trim, parts nomenclature and parts prices. 132 pages.....		\$16.95

All prices listed in catalog subject to change. Call for current prices.

# Model B & V8 Parts 1932-1948

Part # Description Req'd. Years Price

## V-8 Ford Books



VB-12



VB-13 to 15



VB-16



VB-17



VB-18



VB-27



VB-25



VB-28

VB-12	<b>Automotive Hardware and Trim Catalog 1928-38</b> Long sought by restorers, this 168 page book is for trim parts and tells the year and body style on which they belong.....		\$22.95
VB-13 to 15	<b>Mechanic's Repair Manual for V-8's</b> An engine repair manual of proven acceptance by restorers. Pictures and instructions. As follows:		
VB-13	1932-36 (49 pages, 83 illustrations).....		\$22.95
VB-14	1937-38 (36 pages, 49 illustrations).....		\$22.95
VB-15	1939-40 (44 pages, 53 illustrations).....		\$22.95
VB-16	<b>Ford Chassis Parts List 1928-37</b> Car & Truck. Has complete basic part numbers along with exploded illustrations of assemblies. 260 pages.....		\$26.95
VB-17	<b>Ford &amp; Mercury Chassis Parts List 1938-41</b> Car & Truck. 300 pages, 85 illustrations.....		\$29.95
VB-18	<b>The Complete Ford Owner's Handbook of Repair &amp; Maintenance</b> Covers all models of Ford 1932 thru 1955 including V-8 60 hp. 222 pages, 246 illustrations.....		\$22.95
VB-19	<b>Mercury Reference Book, 1939</b> The owner-instruction manual for the new and first Mercury with full data on all the new cars. 62 pages, 29 illustration.....		\$6.95
VB-20	<b>Commercial Car and Truck, 1932-37.</b> Basic information on various model styling Includes photos with details for pickup, station wagon, panel delivery & 131" wheel base trucks. 32 pages, 36 illustrations.....		\$9.50
VB-21	<b>Commercial Car and Truck, 1938-41.</b> Basic information on various detail styling for the years 1938 through 1941. Includes photos with detail for pickup, station wagon, panel delivery and 131 wheel base trucks. Diagrams. 36 pages, 68 illustrations.....		\$9.50
VB-22	<b>Ford Pickups 1932-1952</b> This 150 page book has over 100 factory photos through the years. Gives a spotters guide view of development of the pickup. 194 pictures, both color and black & white.....		\$29.95
VB-24	<b>Service Manual Ford, Mercury &amp; Lincoln 1946-1948.</b> A large book of 256 pages devoted to servicing engines 6, 8, & 12 cylinders and chassis of model years with addendum of car photos & body parts.....		\$22.95
VB-25	<b>Refurbishing Manual for Early Ford V-8 Cars 1937-41 1945-48</b> Contains basics of refinishing the exterior of car and color chips of actual paint used are supplied, as well as the formulas for mixing. 36 pages.....		\$26.95
VB-27	<b>Early Ford V-8 Photo Album 1932-43</b> Takes you back to the 30's in the days of the V-8. 112 pages, 135 black & white illustrations.....		\$19.95
VB-28	<b>Early Ford V-8 As Henry Built It 1932-38</b> The definitive study of the V8 Ford. 220 Pages, over 300 original photos. Authentic production data.....		\$38.95









All prices listed in catalog subject to change. Call for current prices.



# Model B & V8 Parts

**Part # Description Req'd. Years Price**

## V-8 Ford Books

VB-29 to 31		<b>V-8 Service Bulletins</b> These volumes assemble, in reduced format, the complete series of Ford Service Bulletins originally issued in periodic sections by the factory as a primary reference for dealers. VB-29 1932-37 V-8. 544 pages, 750 illustrations.....\$37.95 VB-30 1938-40 V-8. 572 pages, 750 illustrations.....\$37.95 VB-31 1941-48 V-8. 384 pages, 360 illustrations.....\$37.95
	VB-32	<b>Instruction Book — Ford 4 Cylinder Cars &amp; Trucks 1932-34</b> The owner's book for these 4 cyl. cars of the Ford V-8 era .....\$8.95
	VB-33	<b>V-8 Service Manual 1932-41</b> Over 100 illustrations & 222 pages of well detailed info. to aid in the mechanical restoration of Ford & Mercury vehicles.....\$34.95
	VB-33-B	<b>Ford Body Parts List 1933-34</b> .....\$16.95
	VB-34	<b>Instruction Book/ Owner's Manual, 1934.</b> This book came with the new car. Covers many areas of maintenance and operation. 64 pages, 24 illustration.....\$8.95
	VB-35	<b>V-8 Service Manual 1939-48</b> Over 500 illustrations & 475 pages of well detailed instruction covering the mechanical restoration of Ford & Mercury vehicles.....\$46.95
	VB-36	<b>Reference Book for the 1936 Ford V-8</b> Owner instructions for operation & maintenance. Includes lube & wiring charts, plus servicing adjustments. 32 pages, 12 illustrations.....\$8.95
	VB-37	<b>Ford Reference Book, 1937.</b> A regular owner instruction manual for this model year. Provides specifications on 60 hp & 85 hp Ford V-8's. 64 pages, 36 ill.....\$8.95
	VB-38	<b>1938 Ford Reference Book, 85 hp w/Ford V-60 Specifications</b> The owner's instruction manual as supplied with the new 1938 V-8 cars. 64 pages.....\$8.95
	VB-39	<b>Passenger and Commercial Reference Book 1939</b> 61 sections covering maint. & specifications of this year's model.....\$8.95
	VB-40	<b>Passenger and Commercial Reference Book 1940</b> The owner manuals were an education for the cars' owner & driver....\$8.95
	VB-41	<b>Ford Deluxe and Super Deluxe Reference Book 1941</b> Covers maintenance & specifications of this year model \$8.95
	VB-42	<b>Ford Deluxe and Super Deluxe Passenger Car Reference Book 1942</b> Manual with lube charts & wiring diagrams. 64 pages .....\$8.95
	VB-43	<b>1944-52 Ford Body Parts Catalog</b> Assists in determining which part fits which body style. Includes line drawings, descriptions, etc. 464 pages, 145 illus .....\$38.95
	VB-45-1	<b>Hot Rods in the Forties</b> A candid look at hot rodding in the 40's through the photo albums of the rodders. Includes info about the cars, owners, clubs, etc. 283 photos. 144 pages. Hardbound.....\$38.95
	VB-45-2	<b>Hot Rods As They Were</b> The evolution of various styles of hot rods. 160 pgs, 301 photos .....\$38.95
	VB-45-3	<b>Hot Rod Memories</b> Tells & shows hot rodders' activities. 178 pgs., 355 photos.....\$38.95
	VB-45-4	<b>Authentic Hot Rods</b> Back to the 'Good Old Days' of hot rodding. 208 pgs. 502 photos .....\$38.95

All prices listed in catalog subject to change. Call for current prices.

# Model B & V8 Parts 1932-1948

**Part # Description Req'd. Years Price**

## V8 Ford Books

VB-45-8	<b>Old Hot Rod Scrapbook</b> Loaded with photos from the early 30's to the mid-50's Great reference book on hot rodders and their creations. Hardbound. 575 + photos. 192 pages .....		\$39.95
VB-46	<b>Operator's Manual - 1946 Ford Passenger Car, Models 69A &amp; 6GA</b> 44 pages, 17 illustrations .....		\$6.95
VB-47	<b>Operator's Manual - 1947 Ford Passenger Car, Models 79A &amp; 7GA</b> 44 pages .....		\$6.95
VB-48	<b>Operator's Manual - 1948 Ford Passenger Car, Model 899A</b> 39 pages .....		\$6.95
VB-50	<b>Passenger Car Shop Manual, 1949-51</b> This unabridged reprint will supply the owner & restorer with an invaluable reference source and repair tool. It also has an extensive section on body, Convertible & Crestliner tops and Wagon paneling. 320 pages, 700 illustrations .....		\$36.95
VB-52	<b>Passenger Car Shop Manual, 1952,1953,1954</b> The factory-issued shop manual and the 1953 & 1954 shop manual supplements in a single hard-bound volumn. 560 pages, 800 illustrations .....		\$36.95
VB-54	<b>How to Build a Traditional Ford Hot Rod</b> This 160 page "How to" book has 250 black & white illustrations. You'll have the 50's style nostalgia roadster you've always wanted. Author Mike Bishop's approach is timeless .....		\$25.95

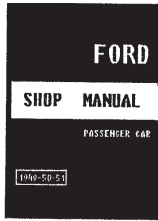

VB-50

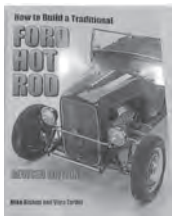

VB-54



VB-45-8

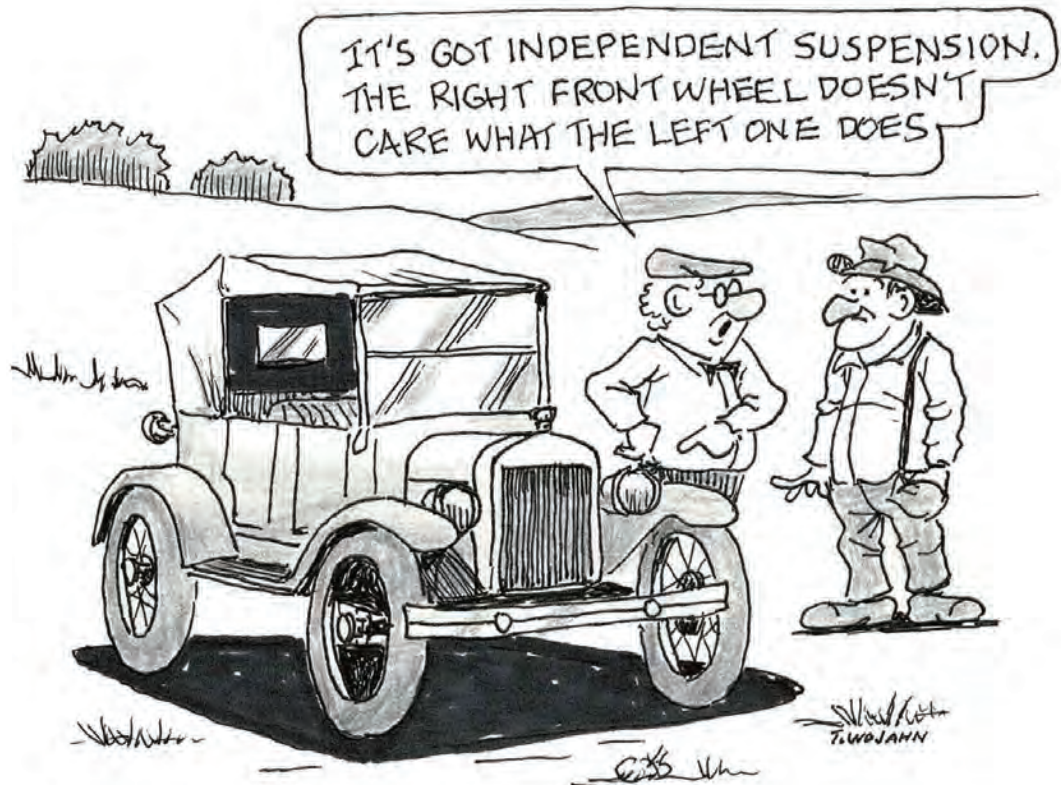

All prices listed in catalog subject to change. Call for current prices.

Part #	Description	Reqd. Years	Price
<b>Model T Ford Books</b>			
TB-1	<b>Model T Service &amp; Repair Manual 1909-27</b> The "Bible" for the Model T man. Original book by company for all Model T years. 320 pages, 577 illustration .....		\$32.95
TB-2	<b>Model T Instruction Book 1909-15</b> This small booklet was supplied for the owner's use. 48 pages, 18 illustrations .....		\$11.95
TB-3	<b>Ford Manual 1915-25</b> The first known attempt to guide the mechanic in repair by questions & answers. 64 pages, 26 illustrations.....		\$11.95
TB-4	<b>Instruction Book 1926-27</b> Although dated as 1926-27, this book notes the changes of the Mid 1920's .....		\$11.95
TB-5	<b>Parts List 1909-15</b> The first book for the Model T engine & chassis. 62 pages .....		\$8.95
TB-6	<b>Model T Parts and Accessories 1909-21</b> Complete parts list for the Model T Ford. 39 pages, 14 ill.....		\$6.95
TB-6A	<b>Ford Price List of Parts.</b> Exact reprint of the 1923 Ford chassis parts list. Issued by Ford to identify the NEW style as well as the older style Model T .....		\$5.95
TB-7	<b>Ford Price List of Parts 1922-27</b> List of engine & chassis parts including Ruckstell axle .....		\$11.95
TB-8	<b>Price List-Chassis &amp; Body Parts 1923</b> 1 Ton TT Truck. 16 pages.....		\$4.95
TB-9	<b>Ford Price List of Body Parts 1923</b> Excellent illustrations of Model T body construction. 39 pages.....		\$8.95
TB-10	<b>Ford Price List of Body Parts 1915-27</b> This is the most complete of Model T body parts' lists including the T pickup & truck.. 93 pages, 37 illustrations .....		\$24.95
TB-11	<b>Windshield &amp; Glass Specifications 1915-27</b> Deminsions & diagrams for Truck and Passenger Car. 14 pages, 47 illustrations .....		\$6.95
TB-13	<b>Ford to Frisco</b> Written by J. Smith Walsh, 41 pages, 1909-27 .....		\$10.95
TB-15	<b>Model T Memories 1909-27</b> Relates experiences one might have with the Model T. Data and information. 112 pages, 59 photos .....		\$21.95
TB-16	<b>Floyd Clymer's Historical Motor Scrapbook</b> Photos & early ads about the Model 'T'. 229 Pages, 250 photos.....		\$16.95
TB-17	<b>Model T Ford Owner's Supply Book 1909-27</b> Information on Model T accessories & replacement parts. 128 pages, 1,000 illustrations .....		\$19.95
TB-18	<b>Model T Ford Restoration Handbook</b> The first book to get into Model T rebuilding. Written by Les Henry, a former Ford curator. 181 pages, 156 illustrations.....		\$29.95
TB-19	<b>Model T Service Bulletins 1909-27</b> A reprint of original Model T service bulletins as issued by Ford. 520 pages, 900 illustrations .....		\$34.95
TB-20	<b>Model T Speed Secrets: The Fast Ford Handbook 1909-27</b> Discover the fast Ford during the trial and errors of early day auto racing. 192 pages, 175 illustrations .....		\$19.95



All prices listed in catalog subject to change. Call for current prices.



TB-21



TB-22



TB-23-C



TB-23-E



TB-23-F

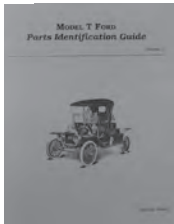

TB-24



TB-24-2

Part #	Description	Reqd. Years	Price
--------	-------------	-------------	-------

## Model T Ford Books

TB-21	<b>The Model T Ford Owner 1909-27</b> Articles covering the performance, operation and technical data. 528 pages, 800 illustrations. Hardbound.....		\$32.95
TB-22	<b>Model T Ford in Speed &amp; Sport 1909-27</b> 224 pages, 300 illustrations.....		\$18.95
TB-23	<b>Model T Axles, Front &amp; Rear 1909-27</b> Great detail in this 30 page restoration manual for 'T' front or rear axles. We offer all 7 titles from <i>Model T Ford Club of America</i> . Our TB-23 thru TB-23-F.....		\$12.00
TB-23-A	<b>Model T Engine Manual 1909-27</b> Repair & restoration of the 'T' motor is covered in this 24 page manual from the <i>MTFCA</i> .....		\$12.00
TB-23-B	<b>Transmission Manual for Model T 1909-27</b> This <i>MTFCA</i> manual of 151 pages takes you step-by-step through the rebuilding of the transmission of the Model 'T'.....		\$12.00
TB-23-C	<b>The Model T Carburetor 1909-27</b> This manual on the 'T' carburetor by the <i>MTFCA</i> is 48 pages, which covers all the carburetors types as found on our 'T's'. Great detail.....		\$12.00
TB-23-D	<b>The Ruckstell Manual for Model T 1909-27</b> The complete Ruckstell R&R manual contains 35 pages of extensive details. Again the <i>MTFCA</i> brings to life an era of technical progress.....		\$12.00
TB-23-E	<b>Electrical Manual, Model T 1919-27</b> <i>The Model T Ford Club of America</i> provides 48 pages of highly detailed information, including generator & starter rebuilding.....		\$12.00
TB-23-F	<b>Speedometer Manual for Model T 1909-27</b> This 62 page manual covers models used throughout 'T' production. Well illustrated. <i>MTFCA</i> offers a look at this topic.....		\$12.00
TB-24	<b>Model T Parts Identification Guide Vol. 1</b> Shows correct part for your Model T year. However not all part numbers listed. Covers early years properly. 61 pages.....		\$17.95
TB-24-2	<b>Model T Parts Identification Guide Vol. 2</b> This second volume has over 260 illustrations to aid you in identifying genuine Model T parts.....		\$17.95
TB-24-3	<b>Model T Parts Identification Guide Vol. 3</b> Over 300 illustrations and 52 pages to aid in identifying Model T parts.....		\$22.95
TB-25	<b>Model T Parts &amp; Accessories 1909-26</b> Illustrated pocket size book shows what years will interchange.....		\$6.95
TB-26	<b>Ford Sales Data Book 1926-27</b> This sales data book, used by salesmen, offers factory accessories for the improved Ford. 40 pages.....		\$6.95











All prices listed in catalog subject to change. Call for current prices.

Part #	Description	Reqd. Years	Price
<b>Model A Ford Books</b>			
 AB-1	 AB-3A	<b>AB-1</b> <b>Model A Restoration Manual 1928-31</b> Contains basic information to acquaint you with data in all respects to the Model A. 72 pages, 29 illustrations & photos.....	\$11.95
		<b>AB-2</b> <b>Model A and AA Parts Price List</b> Late 1931 printing. 84 Pages.....	\$8.50
		<b>AB-3</b> <b>Model A Instruction Book. 1928.</b> Maintenance & repair. 52 pages and 31 illustrations..... It came with the vehicle.	\$14.95
		<b>AB-3A</b> <b>Model A Instruction Book. Late 1931.</b> General maintenance & simple repairs, including AA Truck info. 50 pages with 32 illustration. It came with the vehicle.....	\$14.95
 AB-3/30	 AB-5	<b>AB-3/29</b> <b>Model A Instruction Book. 1929</b> The instruction book provided with the 1929 Model A. This offers many illustrations. 50 pages.....	\$14.95
		<b>AB-3/30</b> <b>Model A Instruction Book. 1930</b> The instruction book provided with the 1930 Model A. This offers many illustrations. 50 pages.....	\$14.95
		<b>AB-5</b> <b>Model A Body Parts List—A &amp; AA 1928-31</b> Lengthy listing of all body parts offered when the Model A was being built. No exploded view of body parts. 251 pages .....	\$29.95
 AB-6	 AB-7	<b>AB-6</b> <b>Model A Construction, Operation &amp; Repair</b> One of the best books by Victor Page on the Model A Ford, its construction, operation and repair. Many pictures .....	\$35.95
		<b>AB-7</b> <b>Model A Miseries and Cures</b> Not a technical or authentic restoration manual. A book for the Ford owner who takes pleasure in driving his car and keeping it in good running condition. 225 pages .....	\$29.95
 AB-8	 AB-9	<b>AB-8</b> <b>Model A Passenger Car &amp; Model AA Truck Engine/Chassis Manual</b> A Dyke's reprint on the Model A. 40 pages, 64 illustrations.....	\$11.95
		<b>AB-9</b> <b>Model A Album</b> Photos of most body styles built. Includes charts, articles, parts and accessories. 143 pages. 50 photographs .....	\$23.95
		<b>AB-11</b> <b>Model A Service Bulletins</b> A compilation of the factory bulletins as supplied to the dealers. 320 pages, 500 illustrations. Hardbound.....	\$32.95
		<b>AB-12</b> <b>The Ford Model A As Henry Built It</b> A wealth of positive information drawn from the Ford archives for the enthusiasts .....	\$39.95
		<b>AB-13</b> <b>Model A Restoration &amp; Maintenance Handbook: Volume # 1</b> 58 pages, 73 illustrations .....	\$14.95
		<b>AB-14</b> <b>Model A Restoration &amp; Maintenance Handbook: Volume #2</b> 59 pages, 115 illustrations .....	\$11.95
 AB-11	 AB-16	<b>AB-15</b> <b>The Model A Ford Carburetors</b> A history of the various styles including rebuilding, testing, and operation. 40 pages. 53 illustrations .....	\$12.95
		<b>AB-16</b> <b>Restoring the Model A &amp; B Carburetor-the 'Rex' Reheis Way</b> Full color, spiral bound, 8-1/2" x 11". 68 pages. Acknowledged as THE book on the Zenith 4 cyl. Carb. 1928-34 .....	\$26.95
		<b>AB-16-T</b> <b>Tillotson Carburetors Repair &amp; Restoration 1928-31</b> Spiral bound w/over 50 illustrations .....	\$19.95
 AB-16-T			

All prices listed in catalog subject to change. Call for current prices.

**Part # Description Req'd. Years Price**

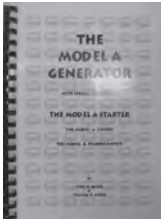
## Model A Ford Books

	AB-17	<b>Model A Ford Restoration Handbook</b> A book for the novice providing valuable input towards restoration of the 'A'. 160 pages. 42 photos. 64 illustrations.....	\$22.95
	AB-18	<b>Antique Ford Repaint Manual 1928-1936</b> Complete color chip guide to authentic colors for the Fords. 16 pages, 55 illustrations & 30 photographs.....	\$26.95
	AB-19	<b>Henry's Fabulous Model A</b> A large book full of interesting information on the Model A. 111 pages, 96 photographs & 20 illustrations .....	\$21.95
	AB-20	<b>Restoring the Model A Ford Pickup</b> A well illustrated book with over 85 pictures and 50 pages offering more pickup information than any other book.....	\$23.95
	AB-21	<b>AA Truck Shop Manual</b> By author of #AB-4. Informative and useful in AA restoration .....	\$24.95
	AB-22	<b>Model A/AA Ford Truck Owner</b> Adapted from a large 1930 sales document. Contains 500 illustrations of commercial vehicles. 228 pages. Hardbound .....	\$29.95
	AB-23	<b>Those Wonderful Unauthorized Accessories</b> Most of the accessories both obscure & familiar have been assembled in this absorbing book of items available during the A's sales years. 256 pages, 450 illustrations. Softbound.....	\$22.95
	AB-24	<b>Matchless Model A</b> Take a step back to the assembly line when the product was the Model A. 64 pages, 150 photos .....	\$14.95
	AB-25	<b>Gem From the River Rouge</b> A detailed and non-technical book on the operation and history of this famous Ford factory. Hardbound .....	\$18.95
	AB-26	<b>Restoring the Open Model A</b> This 72 page book covers all 4 years & all body styles. Backed up with factory details & photos of original cars.....	\$23.95
	AB-27	<b>Shop Kinks and Tools</b> This pocket size book gives an insight into the tools of the time. Used on Model A, B & V-8's. Electrical and many other hints. 84 illustrations. 45 pages .....	\$4.95
	AB-28	<b>Improved Features of the New Ford</b> This compact booklet provides general information about then new 1930-31 Fords. 12 photographs. 18 pages.....	\$3.95
	AB-29	<b>The Model A Generator and Starter</b> Complete restoration manual on Model A & B generators & starters including Powerhouse & Abell. 60 pages & over 50 pictures .....	\$17.95
	AB-30	<b>Model A Coupes</b> Practical information about 1930-31 Coupes. Well illustrated and informative data on this popular body style. 175 pages.....	\$32.95
	AB-32	<b>Model A Ford Mechanics Handbook</b> 425 page book with over 500 illustrations dealing with repair & maintenance of the Model A Ford.....	\$39.95
	AB-32-2	<b>Mechanics Model A Handbook, Vol. 2</b> Pages of information on installing top wood kits, door bumpers, rumble conversions, plus several modern items to enhance your driving of the Model 'A' .....	\$32.95

All prices listed in catalog subject to change. Call for current prices.

Part #	Description	Reqd. Years	Price
<b>Model A Ford Books</b>			
AB-33	<b>Diagnosing Model A Ford</b> Trouble shooting guide with hundreds of illustrations, including in depth analysis. 200 pages.....		\$28.50
AB-35	<b>The Model A Engine Manual</b> This step by step manual has special sections on the distributor and oil pump. Over 150 photos, many in color. Spiral bound 112 pages for easy use.....		\$19.95
AB-36	<b>Advertising the Model A Ford.</b> A collections guide to Model 'A' Ford magazine advertising. Over 400 photographs. By James Thomas.....		\$39.95
<b>V-8 Ford Books</b>			
VB-1	<b>1932 Ford Restorer's Guide</b> A guide to the V-8 and 4 cylinder car on interior, exterior and mechanical servicing of car. 20 pages.....		\$8.95
VB-2	<b>1932 Service Instruction</b> Covers both 4 & 8 Cyl. 88 pages.....		\$11.95
VB-3	<b>1933 Ford Restorer's Guide</b> A guide such as VB-1 except for the 1933 model year also giving exterior-interior and etc. 29 pages. 15 illustrations.....		\$8.95
VB-4	<b>1933 Ford Service Bulletins</b> This is the reprinted compilation of the company service bulletins on the changes over 1932. 88 pages, 64 illustrations.....		\$11.95
VB-5	<b>Restorer's Guide for 1934</b> Details & specifications. 59 pages, 8 illustrations.....		\$6.95
VB-6	<b>Ford Service Instructions 1934</b> Company bulletins to guide dealers and service men through the changes as made in the 1934 car & engine. 103 pgs., 51 illustrations.....		10.95
VB-7	<b>Restorer's Guide for 1935</b> Details & specifications & lists the improvements made with new body & frame. 64 pages, 8 illustrations.....		\$6.95
VB-8	<b>Restorer's Guide for 1936</b> Details & specifications for mechanical and body. 64 pages, 10 illus.....		\$6.95
VB-9	<b>Ford Maintenance Manual 1932-48</b> To help owners keep their cars running during World War II shortages. Issued by the company. 64 pages, 36 illustrations.....		\$8.95
VB-10	<b>Repair Manual, Ford &amp; Mercury V-8 Engines, 1937-48</b> Illustrations & instructions for the repair of these two Ford Engines. 64 pages, 61 illustrations.....		\$11.95
VB-10	<b>Repair Manual, Ford &amp; Mercury V-8 Engines, 1937-48</b> Illustrations & instructions for the repair of these two Ford Engines. 64 pages, 61 illustrations.....		\$11.95
VB-10-A	<b>Repair Manual, Generating &amp; Starting Systems 1933-47</b> This repair manual covers the generators & starters used on the V-8's from 1933-47. 42 pages.....		\$7.95
VB-10-A	<b>Repair Manual, Generating &amp; Starting Systems 1933-47</b> This repair manual covers the generators & starters used on the V-8's from 1933-47. 42 pages.....		\$7.95
VB-10-B	<b>Repair Manual, Fuel System</b> This repair manual covers the carburetors and fuel pumps used on the V-8's from 1938-48. 60 pages.....		\$7.95



AB-33



AB-35



AB-36



VB-6



VB-7

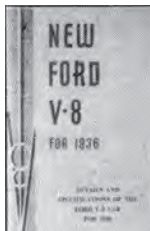

VB-8



VB-10-A



VB-10-B

All prices listed in catalog subject to change. Call for current prices.

Part #	Description	Reqd. Years	Price
<b>V-8 Ford Books</b>			
VB-10-C	<b>Repair Manual, Transmission/Clutch, Overdrives &amp; Power Take-offs. 1932-47 V-8's</b> 80 pages.....		\$7.95
VB-10-H	<b>Hardware &amp; Trim Book 1928-34</b> Over 600 illustrations, and body types cross-indexed. Dealers found this book valuable when ordering parts. 8 1/2 x 11 .....		\$7.95
VB-10-KD	<b>KD Valve Service Tool Box</b> (All years) .....		\$7.95
VB-11	<b>Body Parts List, V-8 &amp; 4 Cylinders 1932</b> Twenty body photos of Model B passenger cars which were identical for both 4 cyl. and V-8 cars. Gives body trim, parts nomenclature and parts prices. 132 pages.....		\$16.95
VB-12	<b>Automotive Hardware and Trim Catalog 1928-38</b> Long sought by restorers, this 168 page book is for trim parts and tells the year and body style on which they belong.....		\$22.95
VB-13 to 15	<b>Mechanic's Repair Manual for V-8's</b> An engine repair manual of proven acceptance by restorers. Pictures and instructions. As follows:		
VB-13	1932-36 (49 pages, 83 illustrations).....		\$22.95
VB-14	1937-38 (36 pages, 49 illustrations).....		\$16.95
VB-15	1939-40 (44 pages, 53 illustrations).....		\$22.95
VB-16	<b>Ford Chassis Parts List 1928-37</b> Car & Truck. Has complete basic part numbers along with exploded illustrations of assemblies. 260 pages.....		\$26.95
VB-17	<b>Ford &amp; Mercury Chassis Parts List 1938-41</b> Car & Truck. 300 pages, 85 illustrations.....		\$29.95
VB-18	<b>The Complete Ford Owner's Handbook of Repair &amp; Maintenance</b> Covers all models of Ford 1932 thru 1955 including V-8 60 hp. 222 pages, 246 illustrations.....		\$23.95
VB-19	<b>Mercury Reference Book, 1939</b> The owner-instruction manual for the new and first Mercury with full data on all the new cars. 62 pages, 29 illustration .....		\$6.95
VB-20	<b>Commercial Car and Truck, 1932-37.</b> Basic information on various model styling Includes photos with details for pickup, station wagon, panel delivery & 131" wheel base trucks. 32 pages, 36 illustrations .....		\$9.50
VB-21	<b>Commercial Car and Truck, 1938-41.</b> Basic information on various detail styling for the years 1938 through 1941. Includes photos with detail for pickup, station wagon, panel delivery and 131 wheel base trucks. Diagrams. 36 pages, 68 illustrations .....		\$9.50
VB-22	<b>Ford Pickups 1932-1952</b> This 150 page book has over 100 factory photos through the years. Gives a spotters guide view of development of the pickup. 194 pictures, both color and black & white .....		\$29.95
VB-24	<b>Service Manual Ford, Mercury &amp; Lincoln 1946 -1948.</b> A large book of 256 pages devoted to servicing engines 6, 8, & 12 cylinders and chassis of model years with addendum of car photos & body parts .....		\$24.95
VB-25	<b>Refurbishing Manual for Early Ford V-8 Cars 1937-41 1945-48</b> Contains basics of refinishing the exterior of car and color chips of actual paint used are supplied, as well as the formulas for mixing. 36 pages .....		\$26.95



VB-10-C



VB-11



VB-12



VB-13 to 15



VB-16



VB-17



VB-18



VB-24











VB-25

All prices listed in catalog subject to change. Call for current prices.



**Part # Description Req'd. Years Price**

## V-8 Ford Books

		VB-27	<b>Early Ford V-8 Photo Album 1932-43</b> Takes you back to the 30's in the days of the V-8. 112 pages, 135 black & white illustrations.....\$19.95
		VB-28	<b>Early Ford V-8 As Henry Built It 1932-38</b> The definitive study of the V8 Ford. 220 Pages, over 300 original photos. Authentic production data.....\$38.95
	VB-28	VB-29 to 31	<b>V-8 Service Bulletins</b> These volumes assemble, in reduced format, the complete series of Ford Service Bulletins originally issued in periodic sections by the factory as a primary reference for dealers.
		VB-29	1932-37 V-8. 544 pages, 750 illustrations.....\$36.95
		VB-30	1938-40 V-8. 572 pages, 750 illustrations.....\$36.95
		VB-31	1941-48 V-8. 384 pages, 360 illustrations.....\$36.95
	VB-34	VB-32	<b>Instruction Book — Ford 4 Cylinder Cars &amp; Trucks 1932-34</b> The owner's book for these 4 cyl. cars of the Ford V-8 era.....\$8.95
		VB-33	<b>V-8 Service Manual 1932-41</b> Over 100 illustrations & 222 pages of well detailed info. to aid in the mechanical restoration of Ford & Mercury vehicles.....\$36.95
	VB-36	VB-33-B	<b>Ford Body Parts List 1933-34</b> .....\$16.95
		VB-34	<b>Instruction Book/ Owner's Manual, 1934.</b> This book came with the new car. Covers many areas of maintenance and operation. 64 pages, 24 illustration.....\$8.95
	VB-37	VB-35	<b>V-8 Service Manual 1939-48</b> Over 500 illustrations & 475 pages of well detailed instruction covering the mechanical restoration of Ford & Mercury vehicles.....\$46.95
		VB-36	<b>Reference Book for the 1936 Ford V-8</b> Owner instructions for operation & maintenance. Includes lube & wiring charts, plus servicing adjustments. 32 pages, 12 illustrations.....\$8.95
	VB-38	VB-37	<b>Ford Reference Book, 1937.</b> A regular owner instruction manual for this model year. Provides specifications on 60 hp & 85 hp Ford V-8's. 64 pages, 36 ill.....\$8.95
		VB-38	<b>1938 Ford Reference Book, 85 hp w/Ford V-60 Specifications</b> The owner's instruction manual as supplied with the new 1938 V-8 cars. 64 pages.....\$8.95
	VB-39	VB-39	<b>Passenger and Commercial Reference Book 1939</b> 61 sections covering maint. & specifications of this year's model.....\$8.95
		VB-40	<b>Passenger and Commercial Reference Book 1940</b> The owner manuals were an education for the cars' owner & driver.....\$8.95
	VB-40	VB-41	<b>Ford Deluxe and Super Deluxe Reference Book 1941</b> Covers maintenance & specifications of this year model.....\$8.95
		VB-42	<b>Ford Deluxe and Super Deluxe Passenger Car Reference Book 1942</b> Manual with lube charts & wiring diagrams. 64 pages.....\$8.95
	VB-46, 47, or 48	VB-43	<b>1944-52 Ford Body Parts Catalog</b> Assists in determining which part fits which body style. Includes line drawings, descriptions, etc. 464 pages, 145 illus.....\$38.95
		VB-45-1	<b>Hot Rods in the Forties</b> A candid look at hot rodding in the 40's through the photo albums of the rodders. Includes info about the cars, owners, clubs, etc. 283 photos. 144 pages. Hardbound.....\$38.95
	VB-42		

All prices listed in catalog subject to change. Call for current prices.

**Part # Description Req'd. Years Price**

## V-8 Ford Books

VB-45-2	<b>Hot Rods As They Were</b> The evolution of various styles of hot rods. 160 pgs, 301 photos.....		\$38.95
VB-45-3	<b>Hot Rod Memories</b> Tells & shows hot rodders' activities. 178 pgs., 355 photos.....		\$38.95
VB-45-4	<b>Authentic Hot Rods</b> Back to the 'Good Old Days' of hot rodding. 208 pgs. 502 photos....		\$38.95
VB-45-8	<b>Old Hot Rod Scrapbook</b> Loaded with photos from the early 30's to the mid-50's Great reference book on hot rodders and their creations. Hardbound. 575 + photos. 192 pages.....		\$39.95
VB-46	<b>Operator's Manual - 1946 Ford Passenger Car, Models 69A &amp; 6GA</b> 44 pages, 17 illustrations.....		\$6.95
VB-47	<b>Operator's Manual - 1947 Ford Passenger Car, Models 79A &amp; 7GA</b> 44 pages.....		\$6.95
VB-48	<b>Operator's Manual - 1948 Ford Passenger Car, Model 899A</b> 39 page.....		\$6.95
VB-50	<b>Passenger Car Shop Manual, 1949-51</b> This unabridged reprint will supply the owner & restorer with an invaluable reference source and repair tool. It also has an extensive section on body, Convertible & Crest liner tops and Wagon paneling. 320 pages, 700 illustrations.....		\$36.95
VB-52	<b>Passenger Car Shop Manual, 1952,1953,1954</b> The factory-issued shop manual and the 1953 & 1954 shop manual supplements in a single hard-bound volumn. 560 pages, 800 illustrations.....		\$36.95
VB-54	<b>How to Build a Traditional Ford Hot Rod</b> This 160 page "How to" book has 250 black & white illustrations. You'll have the 50's style nostalgia roadster you've always wanted. Author Mike Bishop's approach is timeless.....		\$25.95



VB-45-8

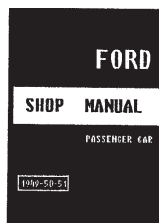

VB-50

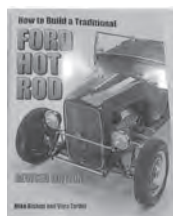

VB-54



MB-3

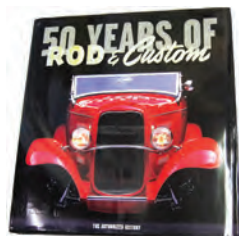

RC-50

## Miscellaneous Books

MB-3	<b>100th Anniversary of Ford, 1903-2003</b> 640 pages, over 1900 photos with 16 color pages. 8 1/2" x 11". Softbound.....		\$24.95
RC-50	<b>50 Years of Rod &amp; Custom</b> .....		\$39.95

## 1909-48 Antique FORD Parts & Accessories



All prices listed in catalog subject to change. Call for current prices.

Part #	Description	Reqd. Years	Price
<b>Extras</b>			
A-HAT	Ford A Baseball Hat.		8.95 ea.
A-LUBE	Model A Lube Chart.		7.50 ea.
A-WPFF	Fabulous Fords Wall Poster.		6.95 ea.
A-WP	Model A Ford Wall Poster.		6.95 ea.
A-11556-A	Key Fob w/Ford Logo. USA.	1928	4.50 ea.
A-11556-B	Key Fob w/Ford Logo. USA.	1929	4.50 ea.
A-11556-C	Key Fob w/Ford Logo. USA.	1930	4.50 ea.
A-11556-D	Key Fob w/Ford Logo. USA.	1931	4.50 ea.
E-2	Model A Ford Decal.	1929	1.00 ea.
E-7	Fabulous Ford Forties Decal.	1940	1.00 ea.
FORD-HAT	Ford Baseball Hat.		8.95 ea.
M-3	Repeal Volstead Act Decal.		1.00 ea.
S/P-L	Step Plates, large non-Ford.		49.95 ea.
S/P-S	Step Plates, small non-Ford.		39.95 ea.
T-HAT	Ford T Baseball Hat.		8.95 ea.
T-LUBE	T Lubrication Chart.		7.50 ea.
T-TS	Model T Troubleshooting Poster.		8.95 ea.
T-WP	Wall Poster showing Model T Parts.		4.95 ea.
V8-HAT	Ford V8 Baseball Hat.		7.95 ea.
V8-LUBE	V8 Lubrication Chart.		7.50 ea.



A-HAT



FORD HAT



Model A Lube Chart



T-Hat



T-TS



T-WP



E-2



E-7



M-3



M-6



M-8



M-7



M-9

## Vintage Decals

All Decals - \$1.00 each (Old stock only available while supplies last!)

E-2	Model A Ford 1929	M-6	Hooray for Hoover
E-7	Fabulous Ford Forties	M-7	Win with Willkie
M-3	Repeal the Volstead Act	M-8	Keep the Hun on the Run
		M-9	Keep 'Em Flying. Buy War Bonds

All prices listed in catalog subject to change. Call for current prices.

# Used Parts



All prices listed in catalog subject to change. Call for current prices.

*Call us to see what used  
& Meyer Drake™ parts  
we have in stock.*

## How To Order

Please include the part numbers and descriptions on the order blank for quick identification. Please include the small amount to help defray the shipping expense. Excess remittance will be refunded. Any amount due will be billed. United Parcel delivery requires a street address.

## Payment

We accept payment by check, money order, Mastercard, Visa, and Discover. Orders can also be shipped on a COD basis. A \$12.00 COD fee is charged by UPS. All orders outside the United States must be paid by International Money Order in US Dollars or by credit card.

## Pricing

We will try to maintain all pricing in this catalog. However, prices are subject to change without notice. Merchandise will be shipped at current pricing. If there is a substantial difference in pricing, we will notify you. Otherwise, we will bill for the difference.

## Return Merchandise

Returned items must be approved first. All returned items must be shipped to us prepaid. We cannot accept any electrical parts for return or exchange — coils, points, condensers, wiring bulbs, etc. All returns must be within 30 days of shipment date.

## Limited Warranties

The seller's products are not guaranteed for any specific length of time, measure of service or fitness for a particular use but are warranted to be free from defects in workmanship and material. Only the warranty herein set forth shall be deemed to have been made by the seller, or relied upon by the buyers, and the express warranty herein stated is in lieu of all other warranties, expressed or implied.

The Seller's liability for breach of the above warranty is limited to refunding the purchase price of the merchandise, or at the seller's option, to replace upon its return. The return of items that have been charged to a credit card will be credited to the card. Under no circumstances shall the seller be responsible for any other form of consequential damage.

No claim for any breach of warranty herein shall be valid unless delivered only in writing to the company within thirty (30) days after date of delivery of the shipment with respect to which claim is made.



# Gaslight Auto Parts

## hours

Monday–Friday  
8:30 AM – 5:00 PM  
EST  
Closed Saturday,  
Sunday, & Major  
Holidays

P.O. Box 291  
Urbana,  
OH 43078

# Order Forms



Gaslight  
Auto Parts

Name \_\_\_\_\_  
E-Mail \_\_\_\_\_  
Phone \_\_\_\_\_  
Address \_\_\_\_\_  
City \_\_\_\_\_  
State \_\_\_\_\_ Zip \_\_\_\_\_  
County (OH residents only) \_\_\_\_\_

**Shipping Address** (if other than left)

UPS deliveries must have street address

Name \_\_\_\_\_  
Address \_\_\_\_\_  
City \_\_\_\_\_  
State \_\_\_\_\_ Zip \_\_\_\_\_

Year of Car \_\_\_\_\_

Body Style \_\_\_\_\_

**hours**  
Monday-Friday  
8:30 AM – 5:00 PM  
EST  
Closed Saturday,  
Sunday, & Major  
Holidays

Qty	Part #	Description	Each	Total

**Approximate Shipping**

- \$8.00 for \$0-\$15 order
- \$12.00 for \$16-\$40 order
- \$15.00 for \$41 or more  
(excluding over-size items)
- COD charge is \$12.00  
(available in US only)

**NO Handling or Service Fees.**  
The actual shipping charge based on weight & dimension. Call for details.

Subtotal \_\_\_\_\_  
Shipping \_\_\_\_\_  
7.25% Tax \_\_\_\_\_  
(Ohio Residents Only)  
**Total** \_\_\_\_\_

**Method of Payment**

- Check, Money Order, COD, or Credit Card
- Mastercard, Visa, & Discover accepted
- Additional costs will be billed, excess will be refunded

**Credit Card Information**

- Card # \_\_\_\_\_
- Expiration Date \_\_\_\_/\_\_\_\_
- Holder's Name \_\_\_\_\_
- Credit card verification number \_\_\_\_\_

**P.O. Box 291**  
**Urbana,**  
**OH 43078**

All parts picked up at our store are subject to 7.25% tax.

All prices listed in catalog subject to change. See [www.GaslightAuto.com](http://www.GaslightAuto.com) for current pricing. Download digital catalog.

## How To Order

Please include the part numbers and descriptions on the order blank for quick identification. Please include the small amount to help defray the shipping expense. Excess remittance will be refunded. Any amount due will be billed. United Parcel delivery requires a street address.

## Payment

We accept payment by check, money order, Mastercard, Visa, and Discover. Orders can also be shipped on a COD basis. A \$12.00 COD fee is charged by UPS. All orders outside the United States must be paid by International Money Order in US Dollars or by credit card.

## Pricing

We will try to maintain all pricing in this catalog. However, prices are subject to change without notice. Merchandise will be shipped at current pricing. If there is a substantial difference in pricing, we will notify you. Otherwise, we will bill for the difference.

## Return Merchandise

Returned items must be approved first. All returned items must be shipped to us prepaid. We cannot accept any electrical parts for return or exchange — coils, points, condensers, wiring bulbs, etc. All returns must be within 30 days of shipment date.

## Limited Warranties

The seller's products are not guaranteed for any specific length of time, measure of service or fitness for a particular use but are warranted to be free from defects in workmanship and material. Only the warranty herein set forth shall be deemed to have been made by the seller, or relied upon by the buyers, and the express warranty herein stated is in lieu of all other warranties, expressed or implied.

The Seller's liability for breach of the above warranty is limited to refunding the purchase price of the merchandise, or at the seller's option, to replace upon its return. The return of items that have been charged to a credit card will be credited to the card. Under no circumstances shall the seller be responsible for any other form of consequential damage.

No claim for any breach of warranty herein shall be valid unless delivered only in writing to the company within thirty (30) days after date of delivery of the shipment with respect to which claim is made.



# Gaslight Auto Parts

## hours

Monday–Friday  
8:30 AM – 5:00 PM  
EST  
Closed Saturday,  
Sunday, & Major  
Holidays

P.O. Box 291  
Urbana,  
OH 43078

# Order Forms



**Gaslight**  
**Auto Parts**

**hours**  
Monday-Friday  
8:30 AM – 5:00 PM  
EST  
Closed Saturday,  
Sunday, & Major  
Holidays

**P.O. Box 291**  
**Urbana,**  
**OH 43078**

Name \_\_\_\_\_  
E-Mail \_\_\_\_\_  
Phone \_\_\_\_\_  
Address \_\_\_\_\_  
City \_\_\_\_\_  
State \_\_\_\_\_ Zip \_\_\_\_\_  
County (OH residents only) \_\_\_\_\_

**Shipping Address** (if other than left)

UPS deliveries must have street address

Name \_\_\_\_\_  
Address \_\_\_\_\_  
City \_\_\_\_\_  
State \_\_\_\_\_ Zip \_\_\_\_\_

Year of Car \_\_\_\_\_ **Body Style** \_\_\_\_\_

Qty	Part #	Description	Each	Total

**Approximate Shipping**

- \$8.00 for \$0-\$15 order
- \$12.00 for \$16-\$40 order
- \$15.00 for \$41 or more (excluding over-size items)
- COD charge is \$12.00 (available in US only)

**NO Handling or Service Fees.**  
The actual shipping charge based on weight & dimension. Call for details.

Subtotal \_\_\_\_\_  
Shipping \_\_\_\_\_  
7.25% Tax \_\_\_\_\_  
(Ohio Residents Only)  
**Total** \_\_\_\_\_

- Method of Payment**
- Check, Money Order, COD, or Credit Card
  - Mastercard, Visa, & Discover accepted
  - Additional costs will be billed, excess will be refunded

- Credit Card Information**
- Card # \_\_\_\_\_
  - Expiration Date \_\_\_/\_\_\_
  - Holder's Name \_\_\_\_\_
  - Credit card verification number \_\_\_\_\_

All parts picked up at our store are subject to 7.25% tax.

All prices listed in catalog subject to change. See www.GaslightAuto.com for current pricing. Download digital catalog.



## How To Order

Please include the part numbers and descriptions on the order blank for quick identification. Please include the small amount to help defray the shipping expense. Excess remittance will be refunded. Any amount due will be billed. United Parcel delivery requires a street address.

## Payment

We accept payment by check, money order, Mastercard, Visa, and Discover. Orders can also be shipped on a COD basis. A \$12.00 COD fee is charged by UPS. All orders outside the United States must be paid by International Money Order in US Dollars or by credit card.

## Pricing

We will try to maintain all pricing in this catalog. However, prices are subject to change without notice. Merchandise will be shipped at current pricing. If there is a substantial difference in pricing, we will notify you. Otherwise, we will bill for the difference.

## Return Merchandise

Returned items must be approved first. All returned items must be shipped to us prepaid. We cannot accept any electrical parts for return or exchange — coils, points, condensers, wiring bulbs, etc. All returns must be within 30 days of shipment date.

## Limited Warranties

The seller's products are not guaranteed for any specific length of time, measure of service or fitness for a particular use but are warranted to be free from defects in workmanship and material. Only the warranty herein set forth shall be deemed to have been made by the seller, or relied upon by the buyers, and the express warranty herein stated is in lieu of all other warranties, expressed or implied.

The Seller's liability for breach of the above warranty is limited to refunding the purchase price of the merchandise, or at the seller's option, to replace upon its return. The return of items that have been charged to a credit card will be credited to the card. Under no circumstances shall the seller be responsible for any other form of consequential damage.

No claim for any breach of warranty herein shall be valid unless delivered only in writing to the company within thirty (30) days after date of delivery of the shipment with respect to which claim is made.



# Gaslight Auto Parts

## hours

Monday–Friday  
8:30 AM – 5:00 PM  
EST  
Closed Saturday,  
Sunday, & Major  
Holidays

P.O. Box 291  
Urbana,  
OH 43078

# Order Forms



# Gaslight Auto Parts

Name \_\_\_\_\_  
 E-Mail \_\_\_\_\_  
 Phone \_\_\_\_\_  
 Address \_\_\_\_\_  
 City \_\_\_\_\_  
 State \_\_\_\_\_ Zip \_\_\_\_\_  
 County (OH residents only) \_\_\_\_\_

**Shipping Address** (if other than left)  
 UPS deliveries must have street address  
 Name \_\_\_\_\_  
 Address \_\_\_\_\_  
 City \_\_\_\_\_  
 State \_\_\_\_\_ Zip \_\_\_\_\_

Year of Car \_\_\_\_\_

Body Style \_\_\_\_\_

**hours**  
 Monday–Friday  
 8:30 AM – 5:00 PM  
 EST  
 Closed Saturday,  
 Sunday, & Major  
 Holidays

Qty	Part #	Description	Each	Total

**Approximate Shipping**

- \$8.00 for \$0-\$15 order
- \$12.00 for \$16-\$40 order
- \$15.00 for \$41 or more (excluding over-size items)
- COD charge is \$12.00 (available in US only)

Subtotal \_\_\_\_\_  
 Shipping \_\_\_\_\_  
 7.25% Tax \_\_\_\_\_  
 (Ohio Residents Only)  
**Total** \_\_\_\_\_

**NO Handling or Service Fees.**  
 The actual shipping charge based on weight & dimension. Call for details.

**Method of Payment**

- Check, Money Order, COD, or Credit Card
- Mastercard, Visa, & Discover accepted
- Additional costs will be billed, excess will be refunded

**Credit Card Information**

- Card # \_\_\_\_\_
- Expiration Date \_\_\_/\_\_\_
- Holder's Name \_\_\_\_\_
- Credit card verification number \_\_\_\_\_

**P.O. Box 291  
 Urbana,  
 OH 43078**

All parts picked up at our store are subject to 7.25% tax.

All prices listed in catalog subject to change. See www.GaslightAuto.com for current pricing. Download digital catalog.